



Quick Coupling Products

*Catalog 3800 USA
February 2005*



The World Standard

Parker Quick Coupling Division Locations



Minneapolis, Minnesota



Grantsburg, Wisconsin



Lincoln, Nebraska



Chetek, Wisconsin

WARNING

FAILURE OR IMPROPER SELECTION OR IMPROPER USE OF THE PRODUCTS AND/OR SYSTEMS DESCRIBED HEREIN OR RELATED ITEMS CAN CAUSE DEATH, PERSONAL INJURY AND PROPERTY DAMAGE.

This document and other information from Parker Hannifin Corporation, its subsidiaries and authorized distributors provide product and/or system options for further investigation by users having technical expertise. It is important that you analyze all aspects of your application and review the information concerning the product or system in the current product catalog. Due to the variety of operating conditions and applications for these products or systems, the user, through its own analysis and testing, is solely responsible for making the final selection of the products and systems and assuring that all performance, safety and warning requirements of the application are met.

The products described herein, including without limitation, product features, specifications, designs, availability and pricing, are subject to change by Parker Hannifin Corporation and its subsidiaries at any time without notice.

Offer of Sale

The items described in this document are hereby offered for sale by Parker Hannifin Corporation, its subsidiaries or its authorized distributors. This offer and its acceptance are governed by the provisions stated in the "Offer of Sale."

© 2005, Revised February 2005 , Parker Hannifin Corporation, All Rights Reserved.



Quick Coupling Division
8145 Lewis Road
Minneapolis, MN 55427



Pneumatic Quick CouplingsSection A

IntroductionA-2
 Coupling Selection GuideA-4
 Interchange Match-up ChartA-5
 Industrial Interchange NipplesA-6
 General PurposeA-8
 Special PurposeA-33
 AccessoriesA-41

Hydraulic Quick CouplingsSection B

IntroductionB-2
 Coupling Selection GuideB-4
 General PurposeB-5
 Non-SpillB-20
 Connect-Under-PressureB-35
 High PressureB-44
 Mold Coolant LineB-48
 High FlowB-53
 Special Purpose - MiniatureB-58
 Dust Plugs and CapsB-60
 Ordering InformationB-63
 Promotional Products-KeychainsB-64

Thermoplastic CouplingsSection C

Coupling Section GuideC-3
 Spectrum SeriesC-4
 PF SeriesC-8
 Ordering InformationC-10

SwivelsSection D

IntroductionD-2
 PS SeriesD-4
 PS Series In-Line SwivelsD-6
 PS Series 90° SwivelsD-15
 PS Series Repair KitsD-26
 S Series SwivelsD-27
 S Series Repair KitsD-33

Check ValvesSection E

IntroductionE-2
 Features & General Technical InformationE-4
 DT SeriesE-5
 CV SeriesE-9
 Ordering InformationE-8, E-11

Diagnostic Products (SensoControl®)Section F

IntroductionF-2
 Selection GuideF-4
 ServiceJuniorF-5
 SensoControl® Serviceman™F-6
 Serviceman™ TransducerF-8
 SensoControl® ServiceMaster™F-11
 ServiceMaster™ TransducerF-14
 PDF Series Flow SensorsF-17
 Test Port CouplingsF-18
 Ordering InformationF-27

AppendicesI-V

Fluid Compatibility ChartI
 Safety GuideII
 Alpha Numeric IndexIII
 Glossary of TermsIV
 Offer of SaleV
 Corporate OverviewInside Back Cover

Pneumatic Quick Couplings

Pneumatic Quick Couplings

Single Shut-Off Couplings

Single Shut-Off couplings are primarily used for pneumatic applications, connecting air tools, hoses, or other implements to compressed air supplies. They are also used with other gases, and with the exception of the E-z-mate Series can be used with low pressure fluids. The coupler half contains a shut-off valve that is automatically opened when a mating nipple is inserted and automatically closes when the nipple is removed.

Parker Single Shut-Off couplings come in three basic designs: general purpose/manual connect, general purpose/push-to-connect, and special purpose.

The standard seal material for all Parker Single Shut-Off couplers is Nitrile. Ethylene Propylene, Fluorocarbon, and Neoprene seals are available as options. See the comprehensive Fluid Compatibility Chart that provides guidelines for seal and body material selection. When there is need for further assistance in selecting the appropriate seal material, please consult factory.

General Ordering Information

When ordering Parker coupler bodies and nipples, please state the part number of each type of coupler body and each type of nipple desired. List coupler bodies and nipples as separate items rather than in combinations. Be sure to double check thread or hose sizes of items required.

Many of Parker's coupling products are available with unique non-standard options well suited to very specific applications. Examples of unusual end use applications might include: high temperatures (above 250° F), extremely caustic/corrosive solutions passing through the coupling, external/environmental corrosion situations, or other high wear and tear situations such as dragging the product along

the ground. It is always recommended that the Quick Coupling Division be contacted with any questions concerning specific product application needs.

Typically, a prefix or suffix is added to the base part number to specify a non-standard O-ring seal, or special option such as a sleeve lock. The list at right illustrates the designations.

Please Note: Certain couplings series have additional "Special Order Information" which should be referred to in ordering those products. If applicable to the product, "Special Order Information" is found next to the Features and Specifications charts. See the Coupling Selection and Ordering Guide for further information.

Checklist for Selecting Quick Couplings

- What are the functional requirements of the coupling?
- What is the maximum working pressure of the application?
- Which seals and body material are compatible with the system's fluid?
- Is the application static or dynamic?
- What size coupler is required?
- What is the maximum pressure drop suitable for the application?
- Does the application require the ability to connect and disconnect under pressure?
- What is the media temperature and ambient temperature?
- What end configurations are required?
- Is an industry interchange coupler required?
- Is air inclusion and fluid loss a concern in the application?



Introduction	A-2	30 Series	A-27 to A-30
Coupling Selection & Ordering Guide	A-4	Couplers	A-29 to A-30
Interchange Match-up Chart	A-5	Twist-Lock Couplings	A-31
Industrial Interchange Nipples	A-6 to A-7	Couplers	A-32
		Nipples	A-32
General Purpose Couplings		Special Purpose Couplings	
Manual Connect	A-8	Standard - Non Marring Composite	A-33
10 Series	A-9	Tool-Mate Series Couplers	A-34
Couplers	A-10	Exhaust - Non Marring Composite	A-35
Nipples	A-11	Tool-Mate Series Couplers	A-36
20 Series	A-12	Exhaust - Steel	A-37
Couplers	A-13	E-z-mate Series	A-37
50 Series	A-14	Couplers	A-38
Couplers	A-14	Breathing Air	
Nipples	A-15	CJ Series	A-39
70 Series	A-16	Couplers	A-40
Couplers	A-16	Nipples	A-40
Nipples	A-16	Accessories	
Push-to-Connect	A-17	Hose Fittings	A-41
RF Series	A-18	Blow Guns	
Couplers	A-19	Controlled Pressure	A-42
Nipples	A-20	Full Pressure	A-42
Tool-Mate Series	See pages A-33 to A-36	BG Series	A-43
HF Series	A-21	Two-Way Valves	A-44
Couplers – 1/8"	A-22		
Nipples – 1/8"	A-22		
Couplers – 1/4", 3/8" & 1/2"	A-23		
HF Series Heavy Duty Couplers – 1/4" & 3/8"	A-24		
HA Series	A-25		
Couplers	A-25		
Nipples	A-15		
Universal Coupler	A-26		
Couplers	A-26		

Coupling Selection & Ordering Guide

Pneumatic Quick Couplings

	Coupler Style	Interchange	Body Size (in.)	Material*				Locking Mechanism	Std. Seal** Material	Std. Seal** Temp Range	Rated Pressure
				B	SS	S	P				
General Purpose – Manual Connect											
10 Series	Manual	Tru-Flate	1/4 to 1/2	●		●		Ball	Nitrile	-40° to +250° F	300 PSI
20 Series ¹	Manual	Industrial	1/4 to 1/2	●	●	●		Ball	Nitrile	-40° to +250° F	300 PSI
50 Series	Manual	ARO 210	1/4	●		●		Ball	Nitrile	-40° to +250° F	300 PSI
70 Series	Manual	Lincoln (long stem)	1/4	●				Ball	Nitrile	-40° to +250° F	300 PSI
General Purpose – Push-To-Connect											
RF Series	Push to Connect	CEJN 320/410 Rectus 25/27	1/4 & 3/8	●		●		Ball	Nitrile	-40° to +250° F	300 PSI
HF Series	Push to Connect	Industrial	1/8 ² to 1/2	●		●		Ball	Nitrile	-40° to +250° F	300 PSI
30 Series	Push to Connect	Industrial	1/4 to 3/4	●				Pawl	Nitrile	-40° to +250° F	300 PSI
HA Series	Push to Connect	ARO 210	1/4	●				Ball	Nitrile	-40° to +250° F	300 PSI
Twist Lock	Push to Connect	Schrader	1/4 to 1/2	●		●		Cam	Nitrile	-40° to +250° F	300 PSI
Universal	Push to Connect	Industrial Tru-Flate ARO 210	1/4	●				Ball	Nitrile	-40° to +250° F	150 PSI
Special Purpose – Push-To-Connect											
E-z-mate Series	Exhaust/ Push to Connect	Industrial	1/4 to 3/4			●		Ball	Nitrile	-40° to +250° F	300 PSI
CJ Series	Push to Connect	CEJN 342/343	1/4	●				Ball	Nitrile	-40° to +250° F	150 PSI
Tool-Mate Series	Push to Connect/ Exhaust & Std	Industrial & CEJN 320 / Rectus 25	1/4 to 1/2			● ³	●	Fingers	Nitrile	-40° to +250° F	300 PSI

¹ 20 Series Stainless Steel available in 1/4" body.

² 1/8" couplings have no standard industry interface.

³ Tool-Mate metal end ports are Galvanized Steel.

*** Material Code:**

B = Brass; SS = Stainless Steel; S = Steel; P = Plastic

Coupling Material**Coupler**

- Prefix "B" for Brass - available for 3/8 & 1/2" body sizes only
- Suffix "N" for Stainless Steel springs, locking balls and brass valves. (10, 20, 30, 50, and 70 series only)

Nipple

- Prefix "B" for Brass (Standard material is steel)

**** Optional Seals**

Material	Suffix	TEMP Range
Ethylene Propylene	W	-65° to +400° F
Fluorocarbon	Y	-30° to +400° F

To select proper seal materials, see Fluid Compatibility Chart in Appendices section, or contact your Parker Quick Coupling Distributor.

Interchange Match-up Chart

Pneumatic Quick Couplings

Popular Coupling Designs

Parker's Quick Coupling Division manufactures quick couplings to interchange with popular designs that have become accepted standards in the industry today. The actual

size nipple chart below can be used to help select Parker Quick Couplings that will interchange with specific nipple designs and sizes.

10 Series (Tru-Flate Interchange)

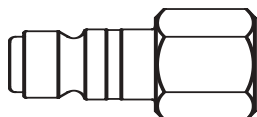

1/4" Body Size

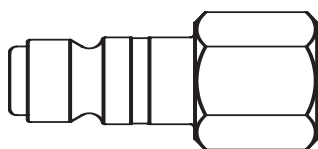

3/8" Body Size

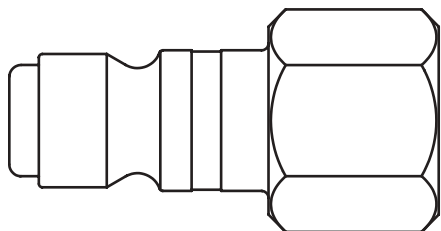

1/2" Body Size

Twist-Lock (Schrader Interchange)

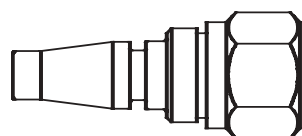

1/4" Body Size

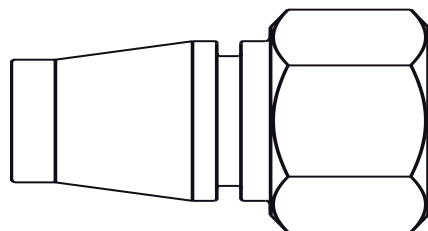

1/2" Body Size

20 Series, 30 Series, HF Series, E-z-mate (Industrial Interchange)

1/8" HF Series

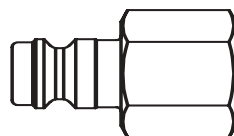

1/8" Body Size

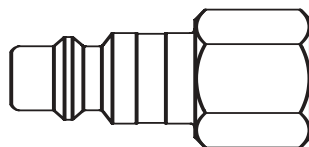

1/4" Body Size

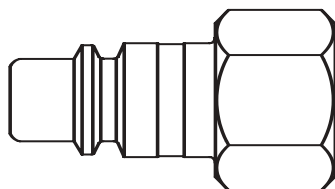

3/8" Body Size

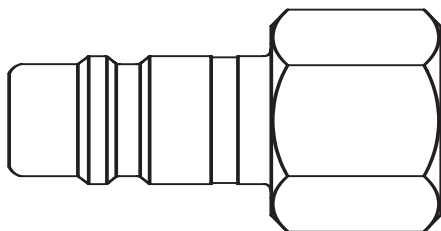

1/2" Body Size

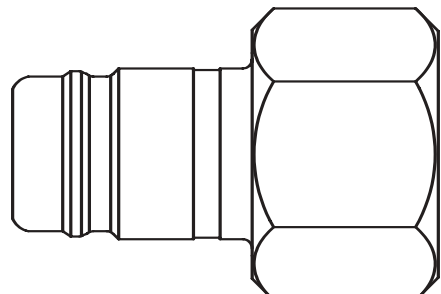

3/4" Body Size

50 Series (ARO-210 Interchange)

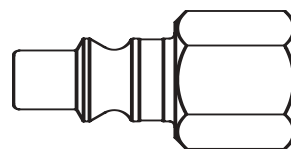

1/4" Body Size

70 Series (Lincoln Interchange)

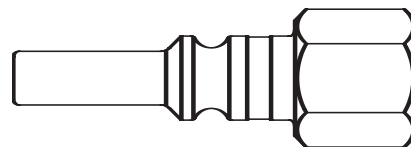

1/4" Body Size

RF Series

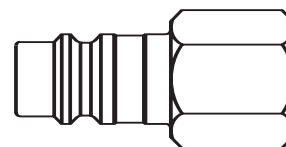

1/4" Body Size

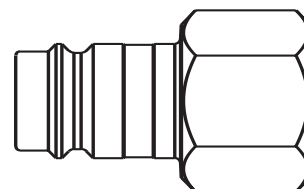

3/8" Body Size

CJ Series (CEJN 342/343 Interchange)

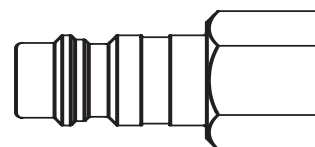

1/4" Body Size

Pneumatic Quick Couplings

Features

- Parker Industrial Interchange nipples are for use with any Parker 20 Series, HF Series, 30 Series, Universal, HF or E-z-mate couplers.
- Parker Industrial Interchange nipples are interchangeable with similar nipples manufactured by other quick coupling manufacturers conforming to A-A-59439 (formerly known as MIL-C-4109F), ANSI/(NFPA) T3.20.14-1990, or ISO6150-B requirements.
- Hardened wear points** and solid barstock construction provide extended service life.
- Precision machined surfaces and hardened load-bearing areas** resist the effects of mechanical shock in the most rugged applications.
- The 20 Series, HF Series, 30 Series, Universal and E-z-mate couplers that mate with the Industrial Interchange nipples are located in their respective coupling "Type" (e.g. Manual Type) as noted in the Table of Contents.

** steel nipples only

Female Pipe Thread

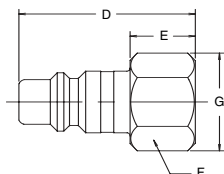

Body Size (in.)	Part No. Brass	Part No. Steel	Part No. Type 303 Stainless	Thread Size NPTF	Overall Length	Dimensions (in.)				Wt. (LB.) P/Piece
						Exposed Length*	Hex Size	Largest Diameter		
					D	E	F	G		
1/4	–	H1C	–	1/8-27	1.38	0.61	0.50	0.58	0.03	
1/4	BH3C	H3C	SH3C	1/4-18	1.56	0.80	0.62	0.72	0.05	
1/4	–	H3C-E	SH3C-E	3/8-18	1.60	0.83	0.81	0.94	0.08	
3/8	–	H1E	–	1/4-18	1.60	0.65	0.62	0.72	0.06	
3/8	BH3E	H3E	–	3/8-18	1.69	0.74	0.81	0.94	0.10	
3/8	–	H3E-F	–	1/2-14	1.84	0.90	1.00	1.16	0.13	
1/2	–	H1F	–	3/8-18	2.03	0.79	0.81	0.94	0.12	
1/2	BH3F	H3F	–	1/2-14	2.25	1.01	1.00	1.16	0.19	
1/2	–	H3F-G	–	3/4-14	2.38	1.13	1.25	1.44	0.26	
3/4	–	H3G-F	–	1/2-14	2.22	1.06	1.31	1.52	0.23	
3/4	–	H3G	–	3/4-14	2.22	1.06	1.31	1.52	0.34	
3/4	–	H3G-J	–	1-11 1/2	2.41	1.25	1.56	1.80	0.47	

*This dimension represents portion of nipple that is exposed when nipple is inserted in a Parker 20 Series coupler.

Male Pipe Thread

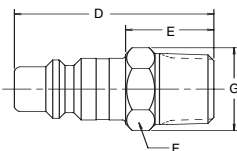

Body Size (in.)	Part No. Brass	Part No. Steel	Part No. Type 303 Stainless	Thread Size NPTF	Overall Length	Dimensions (in.)				Wt. (LB.) P/Piece
						Exposed Length*	Hex Size	Largest Diameter		
					D	E	F	G		
1/4	–	H0C	–	1/8-27	1.56	0.80	0.50	0.58	0.05	
1/4	BH2C	H2C	SH2C	1/4-18	1.66	0.89	0.56	0.65	0.06	
1/4	–	H2C-E	SH2C-E	3/8-18	1.81	1.05	0.69	0.80	0.07	
3/8	–	H00E	–	1/8-27	1.72	0.77	0.62	0.72	0.08	
3/8	–	H0E	–	1/4-18	1.88	0.93	0.62	0.72	0.08	
3/8	BH2E	H2E	–	3/8-18	1.91	0.96	0.69	0.80	0.09	
3/8	–	H2E-F	–	1/2-14	2.12	1.18	0.88	1.02	0.15	
1/2	–	H0F	–	3/8-18	2.31	1.07	0.69	0.79	0.16	
1/2	BH2F	H2F	–	1/2-14	2.48	1.22	0.88	1.01	0.18	
1/2	–	H2F-G	–	3/4-14	2.53	1.29	1.13	1.30	0.24	
3/4	–	H2G-F	–	1/2-14	2.32	1.16	1.00	1.16	0.22	
3/4	BH2G	H2G	–	3/4-14	2.38	1.22	1.06	1.22	0.28	
3/4	–	H2G-J	–	1-11 1/2	2.56	1.40	1.31	1.52	0.36	

*This dimension represents portion of nipple that is exposed when nipple is inserted in a Parker 20 Series coupler.

Pneumatic Quick Couplings

Standard Hose Barb

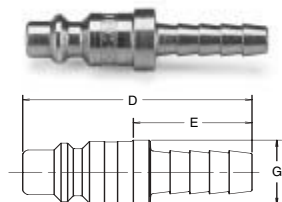

Body Size (in.)	Part No. Brass	Part No. Steel	Part No. Type 303 Stainless	Hose I.D.	Dimension (in.)			Wt. (LB.) P/Piece
					Overall Length	Exposed Length*	Largest Diameter	
					D	E	G	
1/4	-	H8C	-	1/4	1.72	0.95	0.46	0.04
1/4	-	-	SH8C	1/4	2.09	1.33	0.55	0.04
1/4	-	H8C-D	-	5/16	2.09	1.33	0.55	0.04
1/4	-	H9C	SH9C	3/8	2.09	1.33	0.55	0.05
3/8	-	H5E	-	3/8	1.85	.090	0.59	0.07
3/8	-	H6E	-	1/2	2.19	1.24	0.68	0.08
1/2	-	H4F	-	3/8	2.53	1.29	0.68	0.10
1/2	-	H5F	-	1/2	2.53	1.29	0.68	0.11
1/2	-	H5F-G	-	3/4	3.06	1.82	0.93	0.18
3/4	-	H5G-F	-	1/2	2.47	1.31	0.93	0.19
3/4	BH5G	H5G	-	3/4	3.00	1.84	0.93	0.25
3/4	-	H5G-J	-	1	3.24	2.08	1.24	0.36

* This dimension represents portion of nipple that is exposed when nipple is inserted in a Parker 20 Series coupler.

Push-Lok Hose Barb**

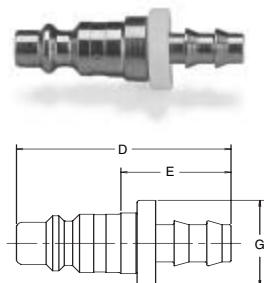

Body Size (in.)	Part No. Brass	Part No. Steel	Hose I.D.	Dimension (in.)			Wt. (LB.) P/Piece	
				Overall Length	Exposed Length*	Largest Diameter		
				D	E	G		
1/4	BH8CP	H8CP	-	1/4	1.74	0.97	.046	0.04
1/4	-	H9CP	-	3/8	2.08	1.31	0.86	0.05
3/8	-	H4EP	-	1/4	1.87	.092	0.59	0.06
3/8	-	H5EP	-	3/8	2.02	1.07	0.59	0.07
3/8	-	H6EP	-	1/2	2.31	1.37	0.97	0.09
1/2	-	H4FP	-	3/8	2.52	1.27	0.86	0.11
1/2	-	H5FP	-	1/2	2.66	1.42	0.97	0.11
1/2	-	H6FP	-	5/8	2.95	1.71	1.14	0.14

*This dimension represents portion of nipple that is exposed when nipple is inserted in a Parker 20 Series coupler.

**Push-Lok hose barbs are designed for use with Parker push-lok hose and do not require clamps.

Pneumatic Quick Couplings

General Purpose – Manual Connect

10 Series, 20 Series, 50 Series, 70 Series

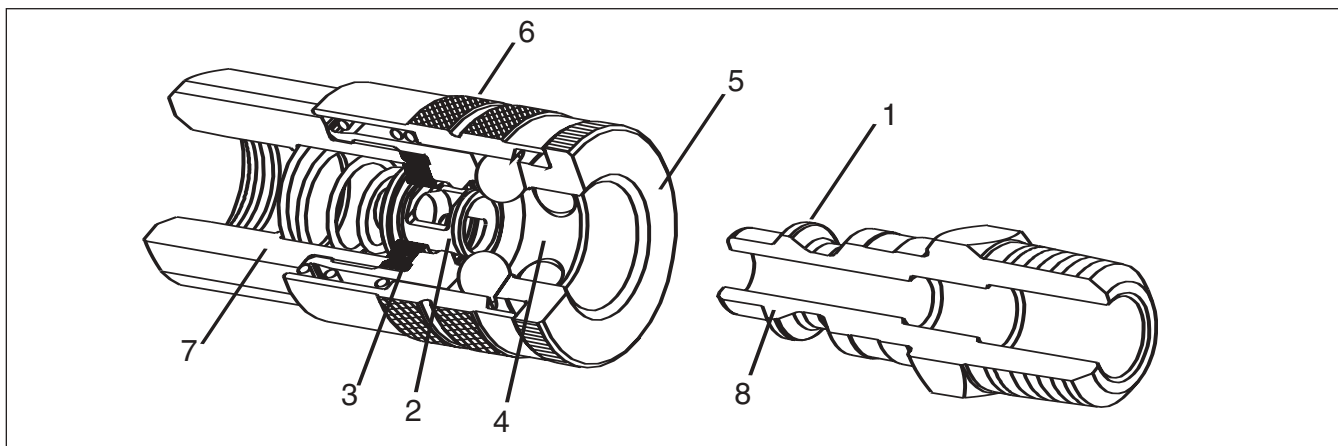

Component Part Features for Manual Couplers, Series 10, 20, 50 & 70 Series

1. Precision machining, hardened wear points* and solid barstock construction provide long life even in rugged applications.
2. Tubular valve with large flow passages delivers high air flow with minimal pressure drop for efficient performance. The tubular design provides 360° support for both the valve seal and the mating nipple for long service life.
3. Precision molded seals form a “bubble tight” seal for reliable operation within rated working pressures. Standard seal material is Nitrile. Ethylene Propylene, Fluorocarbon and Neoprene seals are available as options.
4. Proven ball locking mechanism with large numbers of hardened steel or stainless steel locking balls evenly distribute the load to resist wear and provide positive connections. The ball locking mechanism also provides accurate alignment and allows a swiveling action to reduce hose torque.
5. Integral sleeve guard protects the sleeve and resists accidental disconnects by allowing the coupling to ride over obstructions without the sleeve being retracted.
6. Knurling and/or grooves on sleeve provide a gripping surface for ease of operation.
7. Wide range of body sizes, materials, options and end terminations are available to meet specific needs. Parker sleeve type couplings are available with male pipe thread, female pipe thread, standard hose barb, Push-Lok hose barb**, and reusable hose fitting ends. Standard body materials are brass in 1/4" body size and steel in larger sizes.
8. Parker sleeve type couplings are available in interchanges for industrial interchange, Tru-flate, ARO 210 and Lincoln long stem design nipples.

* Steel nipples only.

** Push-lok hose barbs are designed for use with Parker Push-lok hose and do not require clamps.

Accessories - Coupler Options

Grip-Ring Sleeve - Features

- This Grip-Ring sleeve enables the operator to connect or disconnect the coupling easily, even with greasy hands or while wearing heavy gloves.



- Grip-Ring sleeves are available for all 10 and 20 Series couplers (only). **To specify a model with a Grip-Ring sleeve, add the suffix letter “R” to the regular model number. Example: B13R.**

Caution: The Grip-Ring sleeve is subject to unintended disconnect if dragged on the end of a hose. Do not attempt to pull it over obstacles.

Sleeve-Lok - Features

- All sizes of 10, 20, 30, 50, and 70 Series couplers (only) can be furnished with Locking Sleeves, as illustrated.

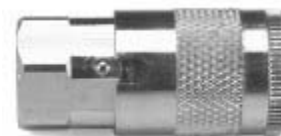

- Place suffix letters -“SL” (Sleeve-Lok) after regular catalog number. Example: B13-SL.

Coupler Repair Kits for 10, 20, 30, 50, 70, & TL Series

Body Size	Seal Material	Part No.
1/4	Nitrile	21K
1/4	Ethylene Propylene	21KW
1/4	Fluorocarbon	21KY
3/8	Nitrile	14K
3/8	Ethylene Propylene	14KW
3/8	Fluorocarbon	14KY
1/2	Nitrile	16K
1/2	Ethylene Propylene	16KW
1/2	Fluorocarbon	16KY
3/4	Nitrile	38K
3/4	Ethylene Propylene	38KW
3/4	Fluorocarbon	38KY



Features

- Parker 10 Series couplings are the original Tru-Flate design.
- This unique design has been field proven as a long lasting, high performance coupling especially when used with pneumatic tools.
- Standard seals are Nitrile. See the Coupling Selection and Ordering Information Guide at the beginning of Section A and the Fluid Compatibility Chart at the end of this catalog for optional materials.

Specifications

Body Size (in.)	1/4	3/8	1/2
Rated Pressure (PSI)	300	300	300
Temperature Range (Std. seals)*	-40° to +250° F.		
Locking Device	4 balls	8 balls	8 balls
Vacuum Data (inches Hg)	Not recommended		
Disconnected (coupler only)	Not recommended		
Connected	27.4	27.4	27.4

* See Coupling Selection and Ordering Guide for Optional Seals
See **Coupling Repair Kits** Table on introduction page to General Purpose - Manual Connect Couplers.

Applications

Sleeve type couplings are widely used to connect air lines and can also be used with low pressure fluids.

Their compact and economical design uses a ball locking mechanism consisting of captive steel balls that engage the locking groove on the mating nipple. The sliding spring loaded sleeve on the coupler must be manually retracted in order to connect or disconnect the nipple. It is easy to do, but two hands are normally required.

Common applications include: compressed air, water, grease, paint, limited vacuum and limited gases.

How to Order Information

The standard 1/4" 10 Series features a brass coupler with a steel valve. Larger sizes include an all steel construction with brass also available. To order a 3/8" or 1/2" coupler with a brass body and steel sleeve, add the prefix "B" to the steel part number, Example: B15.

Add the suffix "N" as well as the "B" prefix to order an all brass coupler with stainless steel locking balls and springs, Example: B15N.

All-brass couplings should be used to avoid corrosion from moisture. Consult factory for specific recommendations.

Available with Sleeve-Lok (See Coupler Options). To order, add the suffix "SL" to the part number, Example: 15-SL.

Available for 1/4" 10 Series couplers is a Grip-Ring Sleeve (See Coupler Options). To order add the suffix "R" to the part number, Example: B13R.

Performance

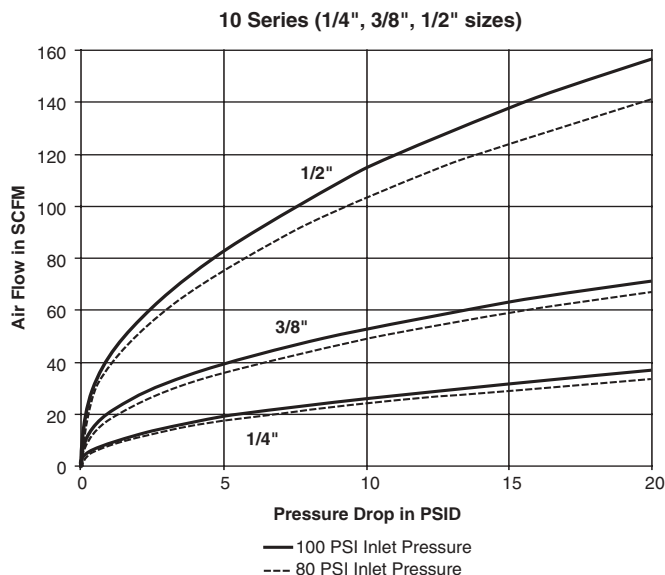

Pneumatic Quick Couplings

General Purpose – Manual Connect

10 Series

Couplers

Female Pipe Thread

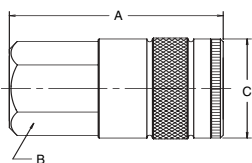
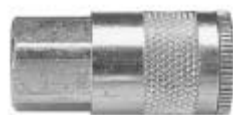

Body Size (in.)	Part No. Brass	Part No. Steel	Thread Size NPTF	Dimensions (in.)			Wt. (LB) P/Piece
				Overall Length	Hex Size	Largest Diameter	
				A	B	C	
1/4	B13A	–	1/8-27	1.83	0.75	0.90	0.19
1/4	B13	–	1/4-18	1.83	0.75	0.90	0.19
1/4	B13E	–	3/8-18	1.95	0.81	0.94	0.31
3/8	–	15C	1/4-18	2.22	0.88	1.06	0.30
3/8	B15	15	3/8-18	2.28	0.88	1.06	0.34
3/8	–	15F	1/2-14	2.55	1.00	1.16	0.46
1/2	–	17E	3/8-18	2.74	1.00	1.19	0.46
1/2	B17	17	1/2-14	2.96	1.00	1.19	0.50
1/2	–	17G	3/4-14	3.19	1.25	1.44	0.20

Male Pipe Thread

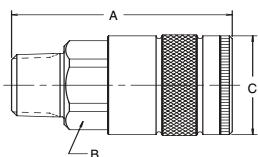

Body Size (in.)	Part No. Brass	Part No. Steel	Thread Size NPTF	Dimensions (in.)			Wt. (LB) P/Piece
				Overall Length	Hex Size	Largest Diameter	
				A	B	C	
1/4	B12A	–	1/8-27	1.89	0.75	0.90	0.17
1/4	B12	–	1/4-18	2.05	0.75	0.90	0.18
1/4	B12E	–	3/8-18	2.08	0.75	0.90	0.19
3/8	–	14C	1/4-18	2.36	0.88	1.06	0.26
3/8	B14	14	3/8-18	2.39	0.88	1.06	0.27
3/8	–	14F	1/2-14	2.55	0.88	1.06	0.28
1/2	–	16E	3/8-18	2.93	1.00	1.19	0.42
1/2	B16	16	1/2-14	3.08	1.00	1.19	0.45
1/2	–	16G	3/4-14	3.21	1.13	1.30	0.50

Standard Hose Barb

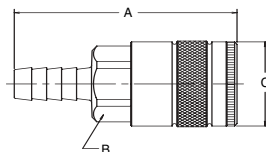

Body Size (in.)	Part No. Brass	Part No. Steel	Hose I.D.	Dimensions (in.)			Wt. (LB) P/Piece
				Overall Length	Hex Size	Largest Diameter	
				A	B	C	
1/4	B10-3B	–	1/4	2.49	0.75	0.90	0.18
1/4	B10-4B	–	5/16	2.49	0.75	0.90	–
1/4	B10-5B	–	3/8	2.49	0.75	0.90	0.18
3/8	–	14-5B	3/8	2.86	0.88	1.06	0.26
3/8	–	14-6B	1/2	3.08	0.88	1.06	0.27
1/2	–	16-5B	3/8	3.37	1.00	1.19	0.41
1/2	–	16-6B	1/2	3.62	1.00	1.19	0.43
1/2	–	16-7B	3/4	3.96	1.00	1.19	0.48

Push-Lok Hose Barb*

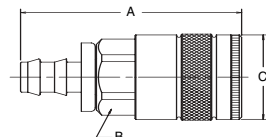

Body Size (in.)	Part No. Brass	Part No. Steel	Hose I.D.	Dimensions (in.)			Wt. (LB) P/Piece
				Overall Length	Hex Size	Largest Diameter	
				A	B	C	
1/4	B10-3BP	–	1/4	2.32	0.75	0.90	0.19
1/4	B10-5BP	–	3/8	2.47	0.75	0.90	0.19
3/8	–	14-5BP	3/8	2.88	0.88	1.06	0.26
1/2	–	16-5BP	3/8	3.35	1.00	1.19	0.40
1/2	–	16-6BP	1/2	3.46	1.00	1.19	0.43

* Push-Lok hose barbs are designed for use with Parker Push-Lok hose and do not require clamps.

Pneumatic Quick Couplings

General Purpose – Manual Connect 10 Series

Nipples

Female Pipe Thread

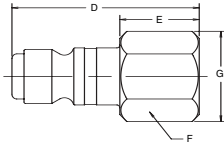

Body Size (in.)	Part No. Brass	Part No. Steel	Thread Size NPTF	Dimensions (in.)				Wt. (LB) P/Piece
				Overall Length	Exposed Length*	Hex Size	Largest Diameter	
				D	E	F	G	
1/4	–	1C	1/8-27	1.28	0.55	0.50	0.58	0.05
1/4	B3C	3C	1/4-18	1.47	0.74	0.62	0.72	0.05
1/4	–	3C-E	3/8-18	1.50	0.77	0.81	0.94	0.07
3/8	–	1E	1/4-18	1.60	0.67	0.62	0.72	0.07
3/8	–	3E	3/8-18	1.68	0.77	0.81	0.94	0.10
1/2	–	1F	3/8-18	2.05	0.83	0.81	0.94	0.13
1/2	–	3F	1/2-14	2.27	1.05	1.00	1.16	0.18
1/2	–	H3F-G	3/4-14	2.38	1.13	1.25	1.44	0.26

* This dimension represents portion of nipple that is exposed when nipple is inserted in a Parker 10 Series coupler.

Male Pipe Thread

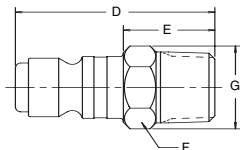

Body Size (in.)	Part No. Brass	Part No. Steel	Part No. Type 303 Stainless	Thread Size NPTF	Dimensions (in.)				Wt. (LB) P/Piece
					Overall Length	Exposed Length*	Hex Size	Largest Diameter	
					D	E	F	G	
1/4	–	0C	–	1/8-27	1.47	0.74	0.50	0.58	0.04
1/4	B2C	2C	S2C	1/4-18	1.62	0.89	0.56	0.65	0.06
1/4	–	2C-E	–	3/8-18	1.72	0.99	0.69	0.80	0.05
3/8	–	0E	–	1/4-18	1.88	0.95	0.62	0.72	0.08
3/8	–	2E	–	3/8-18	1.90	0.98	0.69	0.80	0.09
1/2	–	0F	–	3/8-18	2.33	1.12	0.69	0.79	0.13
1/2	–	2F	–	1/2-14	2.48	1.27	0.88	1.01	0.17
1/2	–	H2F-G	–	3/4-14	2.53	1.29	1.13	1.30	0.24

* This dimension represents portion of nipple that is exposed when nipple is inserted in a Parker 10 Series coupler.

Standard Hose Barb

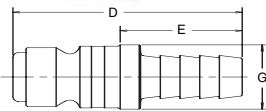

Body Size (in.)	Part No. Steel	Hose I.D.	Overall Length	Dimensions (in.)		Wt. (LB) P/Piece
				Exposed Length*	Largest Diameter	
			D	E	G	
1/4	8C	1/4	1.63	.090	0.45	0.04
1/4	9C	3/8	2.00	1.27	0.55	0.05
3/8	5E	3/8	1.81	0.89	0.59	0.07
1/2	H4F	3/8	2.53	1.29	0.69	0.08
1/2	5F	1/2	2.81	1.60	0.81	0.11
1/2	H5F-G	3/4	3.16	1.91	0.94	0.18

* This dimension represents portion of nipple that is exposed when nipple is inserted in a Parker 10 Series coupler.

Push-Lok Hose Barb**

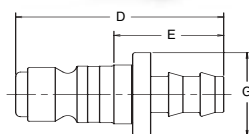

Body Size (in.)	Part No. Steel	Hose I.D.	Overall Length	Dimensions (in.)		Wt. (LB) P/Piece
				Exposed Length*	Largest Diameter	
			D	E	G	
1/4	8CP	1/4	1.66	0.93	0.45	0.04
1/4	9CP	3/8	1.98	1.25	0.86	0.05
3/8	5EP	3/8	1.98	1.06	0.59	0.08
1/2	H4FP	3/8	2.52	1.27	0.86	0.11
1/2	H5FP	1/2	2.66	1.42	0.97	0.11

* This dimension represents portion of nipple that is exposed when nipple is inserted in a Parker 10 Series coupler.

** Push-Lok hose barbs are designed for use with Parker Push-Lok hose and do not require clamps.

Pneumatic Quick Couplings

General Purpose – Manual Connect 20 Series Industrial Interchange



Features

- Parker 20 Series sleeve type couplers accept industrial interchange nipples manufactured by Parker and other manufacturers.
- Standard seals are Nitrile. See the Coupling Selection and Ordering Information Guide at the beginning of Section A and the Fluid Compatibility Chart at the end of this catalog for optional materials.

Specifications

Body Size (in.)	1/4	3/8	1/2
Rated Pressure (psi)	300	300	300
Temperature Range (Std. seals)*	-40° to +250° F.		
Locking Device	4 balls	8 balls	8 balls
Vacuum Data (inches Hg)	Not recommended		
Disconnected (coupler only)	Not recommended		
Connected	27.4	27.4	27.4

* See Coupling Selection and Ordering Guide for Optional Seals
See **Coupling Repair Kits** Table on introduction page to General Purpose - Manual Connect Couplers

How to Order Information

The standard 1/4" 20 Series is a brass coupler with a steel valve. The larger sizes are an all steel construction with brass available as an option. To order a 3/8" or 1/2" body size coupler with a brass body and a steel sleeve and valve, add the prefix "B" to the steel part number. Example: B16.

Add the suffix "N" as well as the "B" prefix to order an all brass coupler with stainless steel locking balls and springs, Example: B25N. All-brass couplings should be used to avoid corrosion from moisture. Consult factory for specific recommendations.

Available with Sleeve-Lok (See Coupler Options at the beginning of Section A). To order, add "-SL" as a suffix to the part number, Example: 25-SL.

Available for 1/4" 20 Series couplers is a Grip-Ring sleeve (See Coupler Options). To order, add the suffix "R" to the part number, Example: B23R.

Applications

Sleeve type couplings are widely used to connect air lines and can also be used with low pressure fluids.

Their compact and economical design uses a ball locking mechanism consisting of captive steel balls that engage the locking groove on the mating nipple. The sliding spring loaded sleeve on the coupler must be manually retracted in order to connect or disconnect the nipple. It is easy to do, but two hands are normally required.

Common applications include: compressed air, water, grease, paint, limited vacuum and limited gases.

Performance

20 Series (1/4", 3/8", 1/2" sizes)

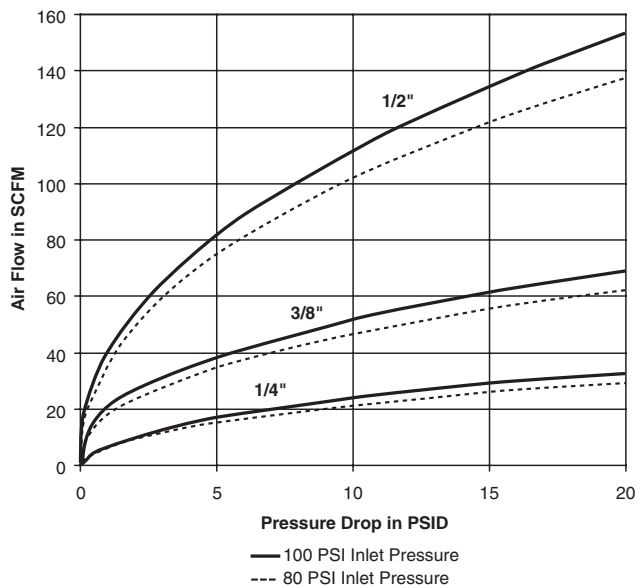

Couplers

Female Pipe Thread

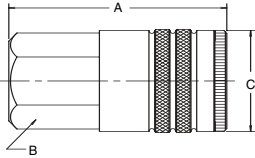

Body Size (in.)	Part No. Brass	Part No. Steel	Part No. Type 303 Stainless	Thread Size NPTF	Dimension (in.)			Wt. (LB) P/Piece
					Overall Length	Hex Size	Largest Diameter	
					A	B	C	
1/4	B23A	–	–	1/8-27	1.83	0.75	0.90	0.20
1/4	B23	–	S23	1/4-18	1.83	0.75	0.90	0.19
1/4	B23E	–	–	3/8-18	1.95	0.81	0.94	0.20
3/8	–	25C	–	1/4-18	2.22	0.88	1.06	0.30
3/8	B25	25	–	3/8-18	2.28	0.88	1.06	0.32
3/8	–	25F	–	1/2-14	2.55	1.00	1.16	0.34
1/2	–	17E	–	3/8-18	2.74	1.00	1.19	0.46
1/2	B17	17	–	1/2-14	2.96	1.00	1.19	0.50
1/2	–	17G	–	3/4-14	3.19	1.25	1.44	0.56

Male Pipe Thread

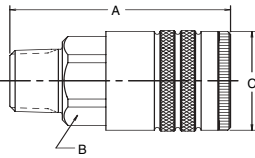

Body Size (in.)	Part No. Brass	Part No. Steel	Part No. Type 303 Stainless	Thread Size NPTF	Dimension (in.)			Wt. (LB) P/Piece
					Overall Length	Hex Size	Largest Diameter	
					A	B	C	
1/4	B22A	–	–	1/8-27	1.89	0.75	0.90	0.18
1/4	B22	–	S22	1/4-18	2.05	0.75	0.90	0.18
1/4	B22E	–	–	3/8-18	2.08	0.75	0.90	0.19
3/8	–	24C	–	1/4-18	2.36	0.88	1.06	0.26
3/8	B24	24	–	3/8-18	2.39	0.88	1.06	0.29
3/8	–	24F	–	1/2-14	2.55	0.88	1.06	0.29
1/2	–	16E	–	3/8-18	2.93	1.00	1.19	0.42
1/2	B16	16	–	1/2-14	3.08	1.00	1.19	0.47
1/2	–	16G	–	3/4-14	3.21	1.13	1.30	0.50

Standard Hose Barb

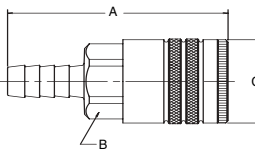

Body Size (in.)	Part No. Brass	Part No. Steel	Hose I.D.	Dimensions (in.)			Wt. (LB) P/Piece
				Overall Length	Hex Size	Largest Diameter	
				A	B	C	
1/4	B20-3B	–	1/4	2.49	0.75	0.90	0.18
1/4	B20-4B	–	5/16	2.49	0.75	0.90	0.18
1/4	B20-5B	–	3/8	2.49	0.75	0.90	0.18
3/8	–	24-5B	3/8	2.86	0.88	1.06	0.27
3/8	–	24-6B	1/2	3.08	0.88	1.06	0.28
1/2	–	16-5B	3/8	3.37	1.00	1.19	0.41
1/2	–	16-6B	1/2	3.62	1.00	1.19	0.43
1/2	–	16-7B	3/4	3.96	1.00	1.19	0.48

Push-Lok Hose Barb*

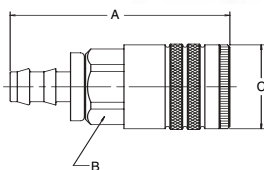

Body Size (in.)	Part No. Brass	Part No. Steel	Hose I.D.	Dimensions (in.)			Wt. (LB) P/Piece
				Overall Length	Hex Size	Largest Diameter	
				A	B	C	
1/4	B20-3BP	–	1/4	2.32	0.75	0.90	0.18
1/4	B20-5BP	–	3/8	2.47	0.75	0.90	0.19
3/8	–	24-5BP	3/8	2.88	0.88	1.06	0.27
1/2	–	16-5BP	3/8	3.35	1.00	1.19	0.40
1/2	–	16-6BP	1/2	3.46	1.00	1.19	0.43

* Push-Lok hose barbs are designed for use with Parker Push-Lok hose and do not require clamps.

Note: See Table of Contents for those nipples used with 20 Series couplers.



Pneumatic Quick Couplings

General Purpose – Manual Connect

50 Series



Features

- Parker 50 Series couplings are interchangeable with ARO's 210 series couplings.
- 50 Series couplings have a full opening tubular valve for maximum flow and a built-in sleeve guard to minimize accidental disconnect.
- 50 Series couplings have all brass bodies and steel valves.
- Standard seal material is Nitrile. See the Coupling Selection and Ordering Information guide at the beginning of Section A and the Fluid Compatibility Chart at the end of this catalog for optional materials.
- Push-to-Connect version available. See HA Series.

Couplers

Female Pipe Thread

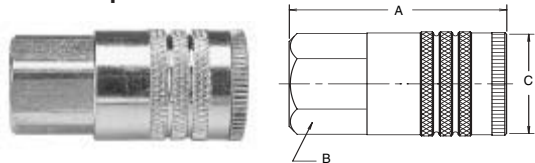

Body Size (in.)	Part No. Brass	Thread Size NPTF	Dimensions (in.)			Wt. (LB) P/Piece
			Overall Length	Hex Size	Largest Diameter	
			A	B	C	
1/4	B53	1/4-18	1.83	0.75	0.90	0.20
1/4	B53E	3/8-18	1.95	0.81	0.94	0.21

Male Pipe Thread

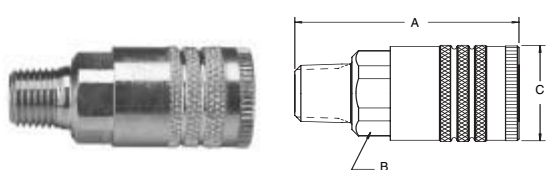

Body Size (in.)	Part No. Brass	Thread Size NPTF	Dimensions (in.)			Wt. (LB) P/Piece
			Overall Length	Hex Size	Largest Diameter	
			A	B	C	
1/4	B52	1/4-18	2.05	0.75	0.90	0.20
1/4	B52E	3/8-18	2.08	0.75	0.90	0.21

Push-Lok Hose Barb*

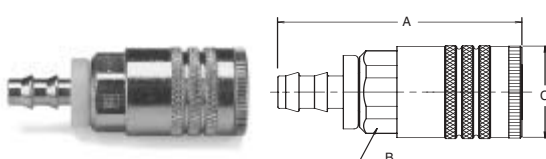

Body Size (in.)	Part No. Brass	Hose I.D.	Dimensions (in.)			Wt. (LB) P/Piece
			Overall Length	Hex Size	Largest Diameter	
			A	B	C	
1/4	B50-3BP	1/4	2.32	0.75	0.90	0.19
1/4	B50-5BP	3/8	2.47	0.75	0.90	0.20

* Push-Lok hose barbs are designed for use with Push-Lok hose and do not require clamps.

Specifications

Body Size (in.)	1/4
Rated Pressure (PSI)	300
Temperature Range (Std. seals)*	-40° to +250° F.
Locking Device	4 balls

* See Coupling Selection and Ordering Guide for Optional Seals.

See **Coupling Repair Kits** Table on introduction page to General Purpose - Manual Connect Couplers

Performance

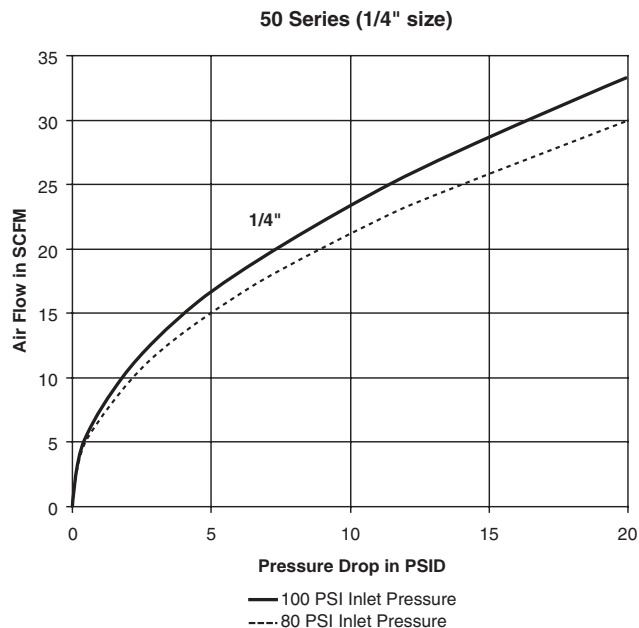

Pneumatic Quick Couplings

General Purpose – Manual Connect 50 Series

Nipples

Female Pipe Thread

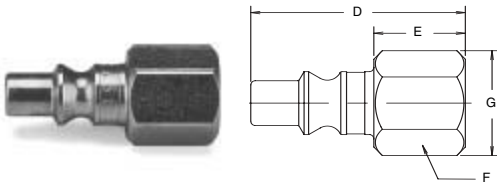

Body Size (in.)	Part No. Steel	Thread Size NPTF	Overall Length	Dimensions (in.)			Wt. (LB) P/Piece
				Exposed Length*	Hex Size	Largest Diameter	
			D	E	F	G	
1/4	A3C	1/4-18	1.47	0.66	0.62	0.72	0.04

* This dimension represents portion of nipple that is exposed when nipple is inserted in a Parker 50 Series coupler.

Male Pipe Thread

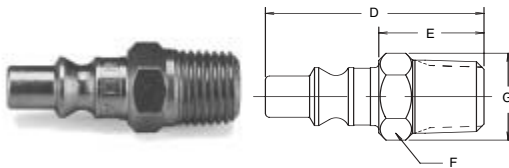

Body Size (in.)	Part No. Steel	Thread Size NPTF	Overall Length	Dimensions (in.)			Wt. (LB) P/Piece
				Exposed Length*	Hex Size	Largest Diameter	
			D	E	F	G	
1/4	A2C	1/4-18	1.62	0.82	0.56	0.65	0.05

* This dimension represents portion of nipple that is exposed when nipple is inserted in a Parker 50 Series coupler.

Standard Hose Barb

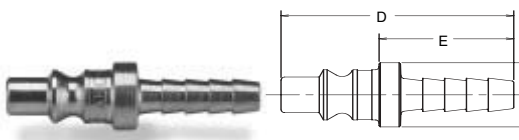

Body Size (in.)	Part No. Steel	Hose I.D.	Overall Length	Dimensions (in.)			Wt. (LB) P/Piece
				Exposed Length*	Largest Diameter		
			D	E	G		
1/4	A8C	1/4	1.63	0.85	.043	0.03	

* This dimension represents portion of nipple that is exposed when nipple is inserted in a Parker 50 Series coupler.

Push-Lok Hose Barb**

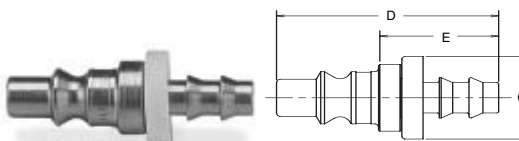

Body Size (in.)	Part No. Steel	Hose I.D.	Overall Length	Dimensions (in.)			Wt. (LB) P/Piece
				Exposed Length*	Largest Diameter		
			D	E	G		
1/4	A8CP	1/4	1.65	0.87	0.43	0.03	

* This dimension represents portion of nipple that is exposed when nipple is inserted in a Parker 50 Series coupler.

** Push-Lok hose barbs are designed for use with Parker push-lok hose and do not require clamps.

Pneumatic Quick Couplings

General Purpose – Manual Connect

70 Series



Features

- Parker 70 Series couplings are interchangeable with Lincoln's "Long Stem" series couplings.
- 70 Series couplings have a full opening tubular valve for maximum flow and a built-in sleeve guard to minimize accidental disconnect.
- The 70 Series is only available in 1/4" body size.
- 70 Series couplings have all brass bodies and steel valves.
- Standard seal material is Nitrile. See the Coupling Selection and Ordering Information Guide at the beginning of Section A and the Fluid Compatibility Chart at the end of this catalog for optional materials.

Couplers

Female Pipe Thread

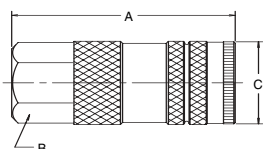

Body Size (in.)	Part No. Brass	Thread Size NPTF	Dimensions (in.)			Wt. (LB) P/Piece
			Overall Length	Hex Size	Largest Diameter	
			A	B	C	
1/4	B73	1/4-18	2.40	0.75	0.90	0.25

Male Pipe Thread

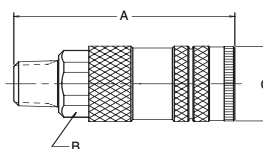

Body Size (in.)	Part No. Brass	Thread Size NPTF	Dimensions (in.)			Wt. (LB) P/Piece
			Overall Length	Hex Size	Largest Diameter	
			A	B	C	
1/4	B72	1/4-18	2.62	0.75	0.90	0.25

Nipples

Female Pipe Thread

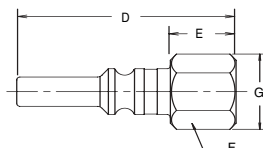

Body Size (in.)	Part No. Steel	Thread Size NPTF	Dimensions (in.)				
			Overall Length	Exposed Length*	Hex Size	Largest Diameter	
			D	E	F	G	
1/4	L3C	1/4-18	2.10	0.77	0.62	0.72	0.05

Male Pipe Thread

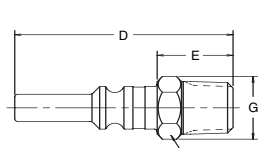

Body Size (in.)	Part No. Steel	Thread Size NPTF	Dimensions (in.)				
			Overall Length	Exposed Length*	Hex Size	Largest Diameter	
			D	E	F	G	
1/4	L2C	1/4-18	2.25	0.92	0.56	0.65	0.06

* This dimension represents portion of nipple that is exposed when nipple is inserted in a Parker 70 Series coupler.

Specifications

Body Size (in.)	1/4
Rated Pressure (psi)	300
Temperature Range (Std. seals)*	-40° to +250° F.
Locking Device	4 balls

* See Coupling Selection and Ordering Guide for Optional Seals.

See **Coupling Repair Kits** Table on introduction page to General Purpose - Manual Connect Couplers

Performance

70 Series (1/4" size)

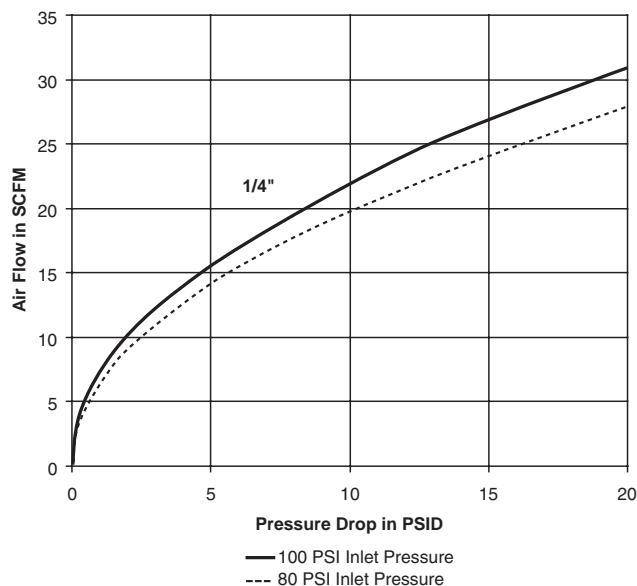

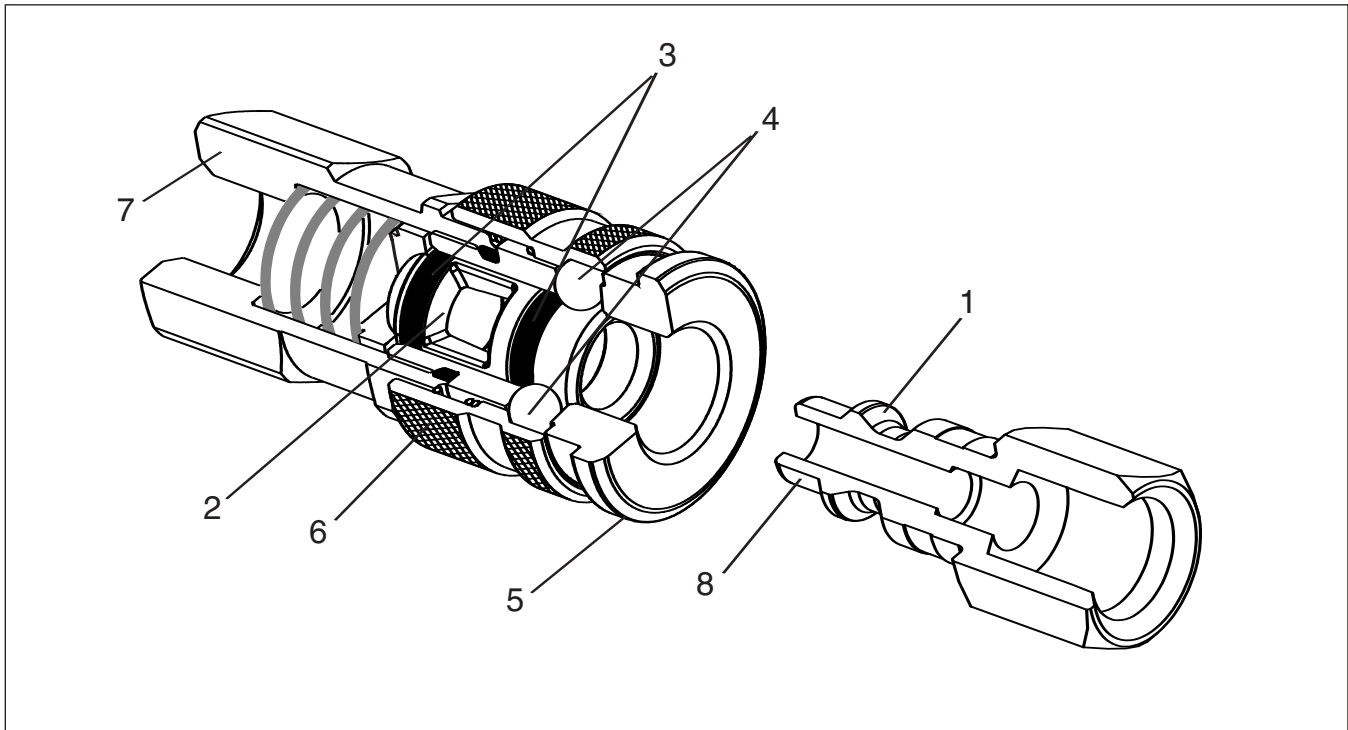

Component Part Features

1. Precision machining, hardened wear points* and solid bar stock construction provide long life even in rugged applications.
2. Tubular valve with large flow passages delivers high flow with minimum pressure drop for efficient performance. The tubular design provides 360° support for both the valve seal and the mating nipple for long service life.
3. Precision molded seals form a “bubble tight” seal for reliable operation within rated working pressures. Standard seal material is Nitrile. Ethylene Propylene, Fluorocarbon and Neoprene are available as options. See the Coupling Selection and Ordering Guide in the front of the Pneumatic Section of the catalog.
4. Proven ball locking mechanism with large numbers of hardened steel or stainless steel locking balls evenly distribute the load to resist wear and provide positive connections. The ball locking mechanism also provides accurate alignment and allows a swiveling action to reduce hose torque.
5. Integral sleeve guard protects the sleeve and resists accidental disconnects by allowing the coupling to ride over obstructions without the sleeve being retracted.
6. Knurling on the sleeve provides a gripping surface for ease of operation.
7. Wide range of end configurations are available to meet specific needs. Parker push-to-connect type couplings are available with male pipe thread, female pipe thread, standard hose barb, and Push-Lok hose barb**.
8. Parker 20, 30, HF, and E-z-mate Series couplings mate with industrial interchange design nipples. See Table of Contents for additional specifications.
9. Push-to-connect design permits one-handed connection when the coupler half is rigidly mounted.

* steel nipples only

** Push-Lok hose barbs are designed for use with Parker Push-Lok hose and do not require clamps.

Pneumatic Quick Couplings

General Purpose – Push-To-Connect RF Series



Features

- Aerodynamic valve design.
- Flow area of the RF nipple is up to 2-1/2 times larger than industrial interchange nipples.
- Flow rates on 1/4" greater than many 3/8" body size couplers.
- Flow rates on 3/8" greater than many 1/2" body size couplers.
- Coupler sleeves are nickel-plated steel and coupler bodies are solid brass construction for excellent corrosion resistance. Standard RF nipples are manufactured from solid steel bar stock, case hardened and plated with yellow zinc chromate for superior service life.
- Dependable ball locking mechanism allows a swiveling action to reduce hose torque.
- Push-To-Connect design for easy one hand connection.
- Integral sleeve guard to protect against accidental disconnection.
- Wide range of port options available.
- More efficient use of compressed air due to higher flows and reduced pressure drop.
- 1/4" body size interchanges with Rectus 25 and Cejn 320 series.
- 3/8" body size interchanges with Rectus 27 and Cejn 410 series.

Specifications

Body Size (in.)	1/4	3/8
Rated Pressure (psi)	300	300
Temperature Range (std seals)	-40° to +250°F	-40° to +250°F
Locking Device	4 balls	8 balls
Vacuum Data (inches Hg)		
Disconnected (coupler only)	Not Recommended	Not Recommended
Connected	Not Recommended	Not Recommended

Description

The Parker RF Series pneumatic couplings offer the quality and dependability customers have come to expect from Parker's line of pneumatic quick couplings. The RF Series has been designed to increase the flow through and reduce the pressure drop over the coupling. The nipple design has up to 2-1/2 times larger flow area than standard industrial interchange nipples. This, along with a specially designed coupler valve, allows tremendous flow through a coupling with an envelope size of current couplings in the market today. The benefits to the end user are increased tool efficiency and decreased air costs.

Performance

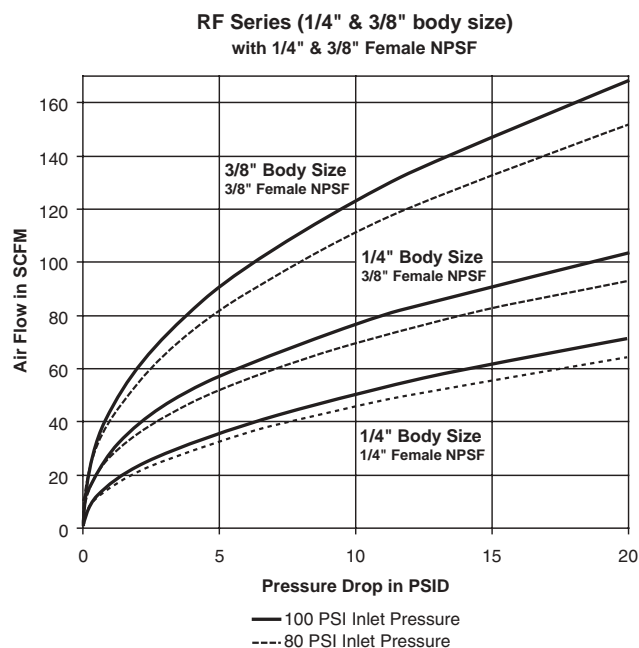

How To Order

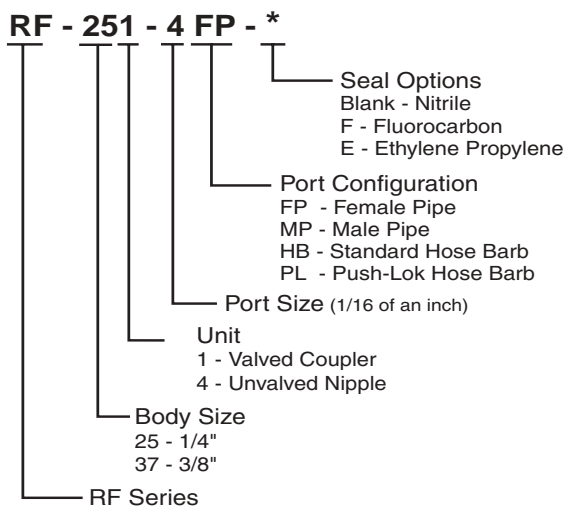

Couplers

Female Pipe Thread

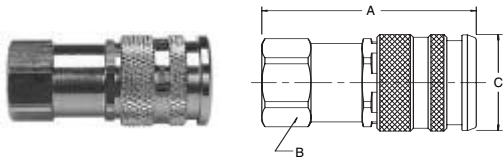

Body Size (in.)	NEW Part No.	OLD Part No.	Thread Size NPSF	Dimensions (in.)			Wt. (LB) P/Piece
				Overall Length	Hex Size	Largest Diameter	
				A	B	C	
1/4	RF-251-4FP	CRF02-4-4	1/4-18	2.19	0.81	0.99	0.26
1/4	RF-251-6FP	CRF02-4-6	3/8-18	2.34	0.81	0.99	0.27
3/8	RF-371-6FP	–	3/8-18	2.33	0.94	1.07	0.31
3/8	RF-371-8FP	–	1/2-14	2.49	1.00	1.07	0.35

Male Pipe Thread

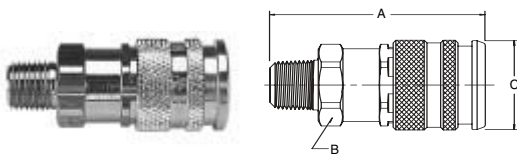

Body Size (in.)	NEW Part No.	OLD Part No.	Thread Size NPTF	Dimensions (in.)			Wt. (LB) P/Piece
				Overall Length	Hex Size	Largest Diameter	
				A	B	C	
1/4	RF-251-4MP	CRF01-4-4	1/4-18	2.34	0.81	0.99	0.24
1/4	RF-251-6MP	CRF01-4-6	3/8-18	2.37	0.81	0.99	0.25
1/4	RF-251-8MP	CRF01-4-8	1/2-14	2.56	0.88	0.99	0.29
3/8	RF-371-6MP	–	3/8-18	2.52	0.94	1.07	0.30
3/8	RF-371-8MP	–	1/2-14	2.68	0.94	1.07	0.33

Standard Hose Barb

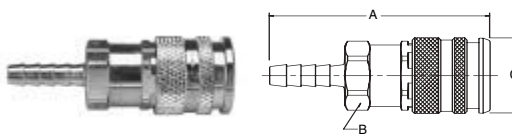

Body Size (in.)	NEW Part No.	OLD Part No.	Hose I.D.	Dimensions (in.)			Wt. (LB) P/Piece
				Overall Length	Hex Size	Largest Diameter	
				A	B	C	
1/4	RF-251-4HB	CRFHB-4-4	1/4	2.81	0.81	0.99	0.26
1/4	RF-251-6HB	CRFHB-4-6	3/8	2.81	0.81	0.99	0.27
3/8	RF-371-6HB	–	3/8	3.02	0.94	1.07	0.31
3/8	RF-371-8HB	–	1/2	3.02	0.94	1.07	0.34

Push-Lok Hose Barb

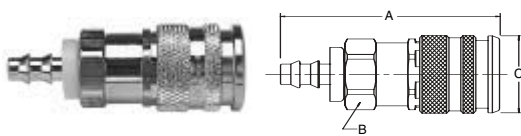

Body Size (in.)	NEW Part No.	OLD Part No.	Hose I.D.	Dimensions (in.)			Wt. (LB) P/Piece
				Overall Length	Hex Size	Largest Diameter	
				A	B	C	
1/4	RF-251-4PL	CRFPL-4-4	1/4	2.64	0.81	0.99	0.26
1/4	RF-251-6PL	CRFPL-4-6	3/8	2.78	0.81	0.99	0.27
1/4	RF-251-8PL	CRFPL-4-8	1/2	2.93	0.81	0.99	0.28
3/8	RF-371-6PL	–	3/8	3.02	0.94	1.07	0.33
3/8	RF-371-8PL	–	1/2	3.02	0.94	1.07	0.33

Pneumatic Quick Couplings

General Purpose – Push-To-Connect RF Series

Nipples

Female Pipe Thread

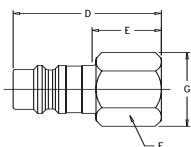

Body Size (in.)	NEW Part No.	OLD Part No.	Thread Size NPTF	Dimensions (in.)				Largest Diameter	Wt. (LB) P/Piece
				Overall Length	Exposed* Length	Hex Size	G		
1/4	RF-254-4FP	NRF02-4-4-S	1/4-18	1.45	0.68	0.62	0.72	0.06	
1/4	RF-254-6FP	NRF02-4-6-S	3/8-18	1.50	0.73	0.81	0.94	0.09	
3/8	RF-374-6FP	–	3/8-18	1.53	0.78	0.81	0.94	0.10	
3/8	RF-374-8FP	–	1/2-14	1.62	0.87	1.00	1.16	0.13	

Male Pipe Thread

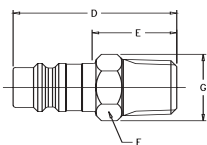

Body Size (in.)	NEW Part No.	OLD Part No.	Thread Size NPTF	Dimensions (in.)				Largest Diameter	Wt. (LB) P/Piece
				Overall Length	Exposed* Length	Hex Size	G		
1/4	RF-254-4MP	NRF01-4-4-S	1/4-18	1.60	0.83	0.56	0.65	0.05	
1/4	RF-254-6MP	NRF01-4-6-S	3/8-18	1.67	0.90	0.69	0.75	0.08	
3/8	RF-374-6MP	–	3/8-18	1.70	0.95	0.69	0.75	0.09	
3/8	RF-374-8MP	–	1/2-14	1.85	1.10	0.88	1.01	0.15	

Standard Hose Barb

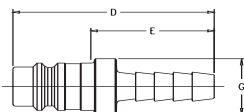

Body Size (in.)	NEW Part No.	OLD Part No.	Hose I.D.	Dimensions (in.)			Largest Diameter	Wt. (LB) P/Piece
				Overall Length	Exposed* Length	G		
1/4	RF-254-4HB	NRFHB-4-4-S	1/4	1.66	0.89	0.50	0.04	
1/4	RF-254-6HB	NRFHB-4-6-S	3/8	1.66	0.89	0.50	0.05	
3/8	RF-374-6HB	–	3/8	1.63	0.88	0.59	0.07	
3/8	RF-374-8HB	–	1/2	1.97	1.22	0.68	0.08	

Push-Lok Hose Barb

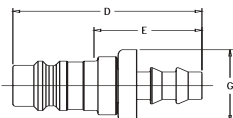

Body Size (in.)	NEW Part No.	OLD Part No.	Hose I.D.	Dimensions (in.)			Largest Diameter	Wt. (LB) P/Piece
				Overall Length	Exposed* Length	G		
1/4	RF-254-4PL	NRFPL-4-4-S	1/4	1.69	0.92	0.50	0.04	
1/4	RF-254-6PL	NRFPL-4-6-S	3/8	1.83	1.06	0.50	0.05	
3/8	RF-374-6PL	–	3/8	1.80	1.05	0.59	0.07	
3/8	RF-374-8PL	–	1/2	2.09	1.34	0.897	0.09	

* This dimension represents portion of nipple that is exposed when nipple is inserted in a Parker RF Series coupler.



Features

- Parker HF Series Pneumatic Quick Couplings offer an alternative to traditional industrial interchange couplers. The quality and durability you have come to expect from Parker 20 Series couplers, combined with a slim profile and push-to-connect design. The result is an easy to use general purpose pneumatic coupler suitable for use in a variety of applications.
- Parker HF couplers feature sleeve guards** to protect against accidental disconnection.
- Standard couplers feature solid brass construction, high flow valving, corrosion resistant valves, and stainless steel locking balls and valve spring.
- Heavy Duty Couplers* featuring heat treated, solid steel bodies and sleeves for added strength and durability.
- Parker HF couplers accept Industrial Interchange nipples*** manufactured by Parker and other manufacturers. See table of contents.

*** 1/8" couplings have no standard industry interface.
 ** 1/8" couplings do not incorporate an integral sleeve guard.
 * 1/8" and 1/2" are unavailable in the Heavy Duty version.

How To Order

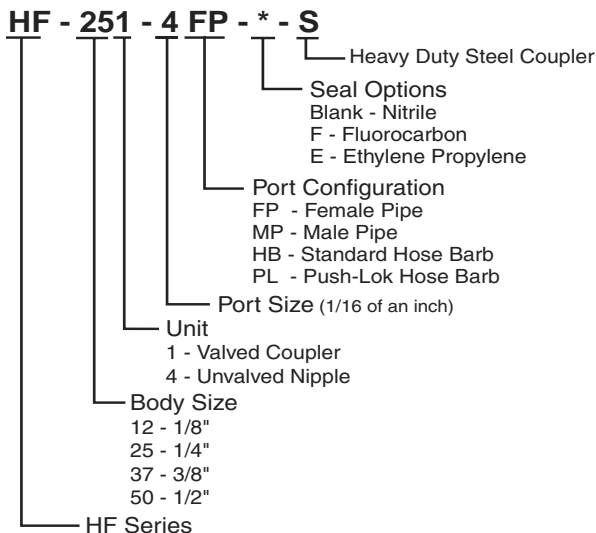

Specifications

Body Size (in.)	1/8	1/4	3/8	1/2
Rated Pressure (psi)	250	300	300	300
Temperature Range (Std. seals)	-40° to +250°F			
Locking Device	5 balls	4 balls	6 balls	8 balls
Vacuum Data (inches Hg)	Disconnected (coupler only) Not Recommended			
Connected	—	27.4	27.4	27.4

Performance

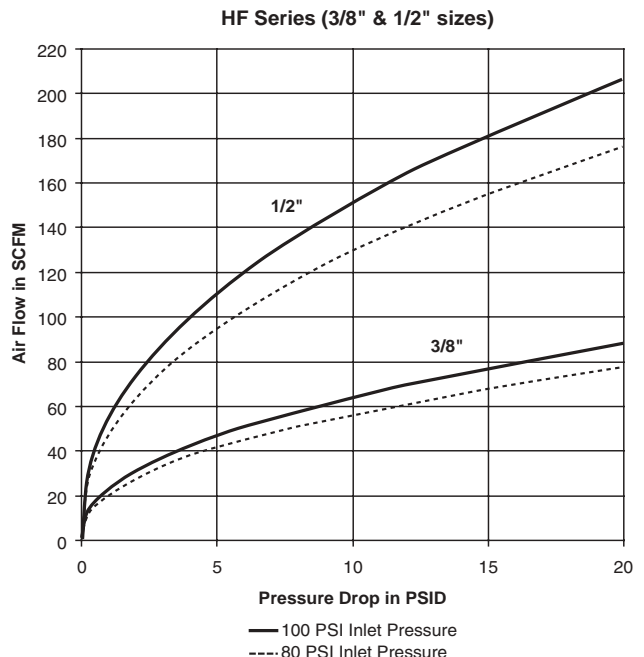
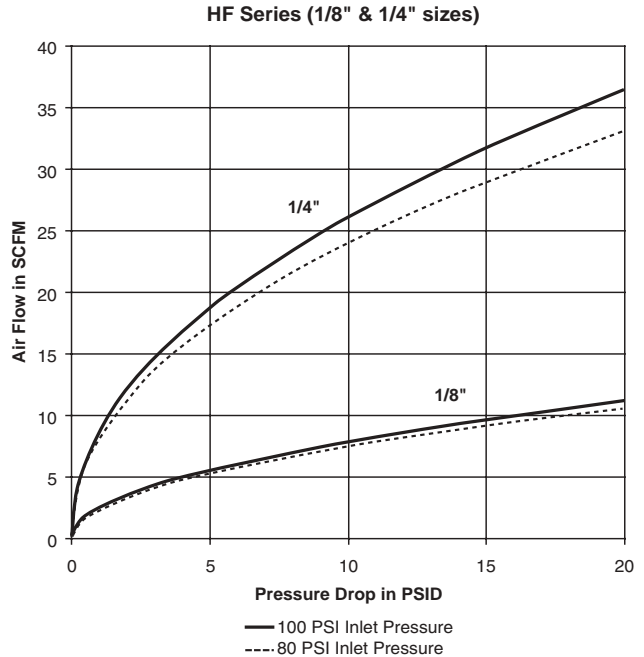

Pneumatic Quick Couplings

General Purpose – Push-To-Connect HF Series Industrial Interchange

1/8" Body Size Couplers

Female Pipe Thread

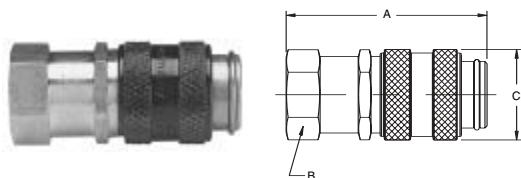

Body Size (in.)	New Part No. Brass	Old Part No. Brass	Thread Size NPTF	Dimensions (in.)			Wt. (LB) P/Piece
				Overall Length	Hex Size	Largest Diameter	
				A	B	C	
1/8	HF-121-2FP	HF302F-2	1/8-27	1.42	0.55	0.63	0.06
1/8	HF-121-4FP	HF302F-4	1/4-18	1.81	0.67	0.63	0.10

Male Pipe Thread

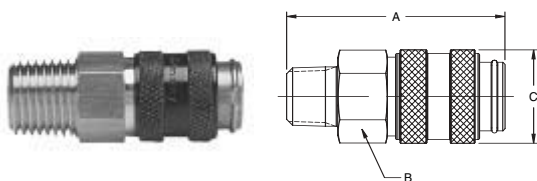

Body Size (in.)	New Part No. Brass	Old Part No. Brass	Thread Size NPTF	Dimensions (in.)			Wt. (LB) P/Piece
				Overall Length	Hex Size	Largest Diameter	
				A	B	C	
1/8	HF-121-2MP	HF302M-2	1/8-27	1.50	0.55	0.63	0.06
1/8	HF-121-4MP	HF302M-4	1/4-18	1.61	0.55	0.63	0.07

1/8" Body Size Nipples

Female Pipe Thread

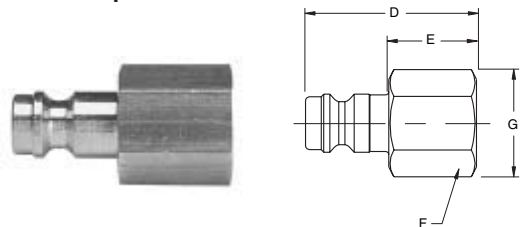

Body Size (in.)	New Part No. Brass	Old Part No. Brass	Thread Size NPTF	Dimensions (in.)			
				Overall Length	Exposed Length*	Hex Size	Largest Diameter
				D	E	F	G
1/8	HF-124-2FP	HF702F-2	1/8-27	1.08	0.55	0.50	0.58
1/8	HF-124-4FP	HF702F-4	1/4-18	1.34	0.81	0.67	0.78

* This dimension represents the portion that is exposed when nipple is inserted in a Parker HF series coupler.

Male Pipe Thread

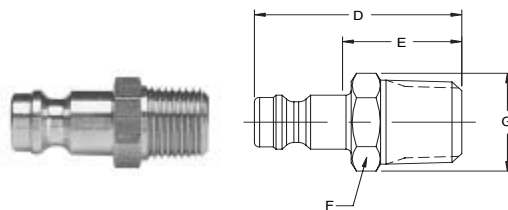

Body Size (in.)	New Part No. Brass	Old Part No. Brass	Thread Size NPTF	Dimensions (in.)			
				Overall Length	Exposed Length*	Hex Size	Largest Diameter
				D	E	F	G
1/8	HF-124-2MP	HF702M-2	1/8-27	1.06	0.53	0.44	0.51
1/8	HF-124-4MP	HF702M-4	1/4-18	1.25	0.72	0.56	0.63

* This dimension represents the portion that is exposed when nipple is inserted in a Parker HF series coupler.

Pneumatic Quick Couplings

General Purpose – Push-To-Connect HF Series Industrial Interchange

1/4" and 3/8" Body Size Couplers

Female Pipe Thread

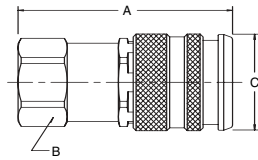

Body Size (in.)	New Part No. Brass	Old Part No. Brass	Thread Size NPSF	Dimensions (in.)			Wt. (LB) P/Piece
				Overall Length	Hex Size	Largest Diameter	
				A	B	C	
1/4	HF-251-4FP	HF304F-4	1/4-18	2.19	0.81	0.99	0.26
1/4	HF-251-6FP	HF304F-6	3/8-18	2.34	0.81	0.99	0.27
3/8	HF-371-4FP	HF306F-4	1/4-18	2.33	0.94	1.07	0.33
3/8	HF-371-6FP	HF306F-6	3/8-18	2.33	0.94	1.07	0.31
3/8	HF-371-8FP	HF306F-8	1/2-14	2.49	1.00	1.07	0.35
1/2	HF-501-8FP	–	1/2-14	3.35	1.06	1.19	0.60

Male Pipe Thread

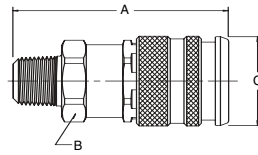

Body Size (in.)	New Part No. Brass	Old Part No. Brass	Thread Size NPTF	Dimensions (in.)			Wt. (LB) P/Piece
				Overall Length	Hex Size	Largest Diameter	
				A	B	C	
1/4	HF-251-4MP	HF304M-4	1/4-18	2.34	0.81	0.99	0.25
1/4	HF-251-6MP	HF304M-6	3/8-18	2.37	0.81	0.99	0.26
3/8	HF-371-4MP	HF306M-4	1/4-18	2.49	0.94	1.07	0.32
3/8	HF-371-6MP	HF306M-6	3/8-18	2.52	0.94	1.07	0.30
3/8	HF-371-8MP	HF306M-8	1/2-14	2.68	0.94	1.07	0.33
1/2	HF-501-8MP	–	1/2-14	3.48	1.06	1.19	0.57

Standard Hose Barb

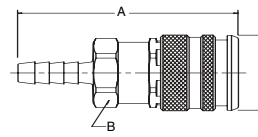

Body Size (in.)	New Part No. Brass	Old Part No. Brass	Hose I.D.	Dimensions (in.)			Wt. (LB) P/Piece
				Overall Length	Hex Size	Largest Diameter	
				A	B	C	
1/4	HF-251-4HB	HF304HB-4	1/4	2.81	0.81	0.99	0.26
1/4	HF-251-6HB	HF304HB-6	3/8	2.81	0.81	0.99	0.27
3/8	HF-371-6HB	HF306HB-6	3/8	3.02	0.94	1.07	0.31
3/8	HF-371-8HB	HF306HB-8	1/2	3.02	0.94	1.07	0.34

Push-Lok Hose Barb

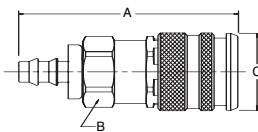

Body Size (in.)	New Part No. Brass	Old Part No. Brass	Hose I.D.	Dimensions (in.)			Wt. (LB) P/Piece
				Overall Length	Hex Size	Largest Diameter	
				A	B	C	
1/4	HF-251-4PL	HF304PL-4	1/4	2.64	0.81	0.99	0.26
1/4	HF-251-6PL	HF304PL-6	3/8	2.78	0.81	0.99	0.27
3/8	HF-371-6PL	HF306PL-6	3/8	3.02	0.94	1.07	0.33
3/8	HF-371-8PL	HF306PL-8	1/2	3.07	0.94	1.07	0.31

Pneumatic Quick Couplings

General Purpose – Push-To-Connect HF Series Industrial Interchange

Heavy Duty Couplers

Female Pipe Thread

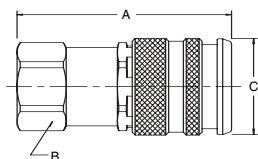

Body Size (in.)	New Part No. Steel	Old Part No. Steel	Thread Size NPSF	Dimensions (in.)			Wt. (LB) P/Piece
				Overall Length	Hex Size	Largest Diameter	
				A	B	C	
1/4	HF-251-4FP-S	HF404F-4	1/4-18	2.19	0.81	0.99	0.26
1/4	HF-251-6FP-S	HF404F-6	3/8-18	2.34	0.81	0.99	0.27
3/8	HF-371-4FP-S	HF406F-4	1/4-18	2.33	0.94	1.07	0.33
3/8	HF-371-6FP-S	HF406F-6	3/8-18	2.33	0.94	1.07	0.31
3/8	HF-371-8FP-S	HF406F-8	1/2-14	2.49	1.00	1.07	0.35

Male Pipe Thread

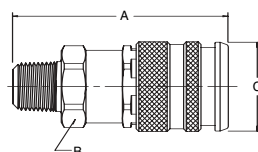

Body Size (in.)	New Part No. Steel	Old Part No. Steel	Thread Size NPTF	Dimensions (in.)			Wt. (LB) P/Piece
				Overall Length	Hex Size	Largest Diameter	
				A	B	C	
1/4	HF-251-4MP-S	HF404M-4	1/4-18	2.34	0.81	0.99	0.25
1/4	HF-251-6MP-S	HF404M-6	3/8-18	2.37	0.81	0.99	0.26
3/8	HF-371-4MP-S	HF406M-4	1/4-18	2.49	0.94	1.07	0.32
3/8	HF-371-6MP-S	HF406M-6	3/8-18	2.52	0.94	1.07	0.30
3/8	HF-371-8MP-S	HF406M-8	1/2-14	2.68	0.94	1.07	0.33

Standard Hose Barb

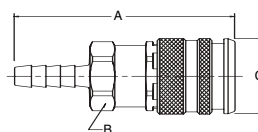

Body Size (in.)	New Part No. Steel	Old Part No. Steel	Hose I.D.	Dimensions (in.)			Wt. (LB) P/Piece
				Overall Length	Hex Size	Largest Diameter	
				A	B	C	
1/4	HF-251-4HB-S	HF404HB-4	1/4	2.81	0.81	0.99	0.26
1/4	HF-251-6HB-S	HF404HB-6	3/8	2.81	0.81	0.99	0.27
3/8	HF-371-6HB-S	HF406HB-6	3/8	3.02	0.94	1.07	0.31
3/8	HF-371-8HB-S	HF406HB-8	1/2	3.02	0.94	1.07	0.34

Push-Lok Hose Barb

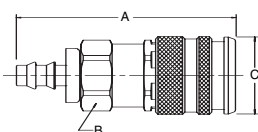

Body Size (in.)	New Part No. Steel	Old Part No. Steel	Hose I.D.	Dimensions (in.)			Wt. (LB) P/Piece
				Overall Length	Hex Size	Largest Diameter	
				A	B	C	
1/4	HF-251-4PL-S	HF404PL-4	1/4	2.64	0.81	0.99	0.26
1/4	HF-251-6PL-S	HF404PL-6	3/8	2.78	0.81	0.99	0.27
3/8	HF-371-6PL-S	HF406PL-6	3/8	3.02	0.94	1.07	0.33
3/8	HF-371-8PL-S	HF406PL-8	1/2	3.07	0.94	1.07	0.31



Features

- Parker HA Series couplings are interchangeable with ARO's 210 series couplings. See Table of Contents.
- Push to Connect design for easy one hand operation.
- HA Series couplings utilize a tubular valve for maximum flow and a built-in sleeve guard to minimize accidental disconnect.
- The HA Series is only available in 1/4" body size.
- HA Series couplings have all brass bodies.
- Standard seal material is Nitrile. See the Coupling Selection and Ordering Information Guide at the beginning of Section A and the Fluid Compatibility Chart at the end of this catalog for optional materials.
- Other port options available – contact the division.
- Formerly the 50A Series.

Couplers

Female Pipe Thread

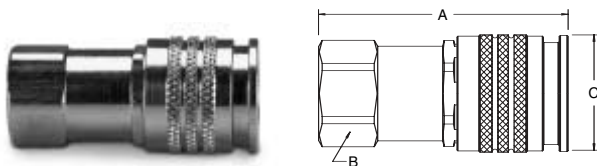

Male Pipe Thread

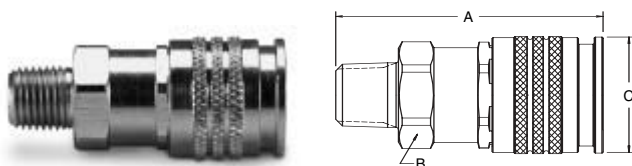

Specifications

Body Size (in.)	1/4
Rated Pressure (psi)	300
Temperature Range (Std. seals)	-40° to +250° F
Locking Device	4 balls
Vacuum Service	Not Recommended

Performance

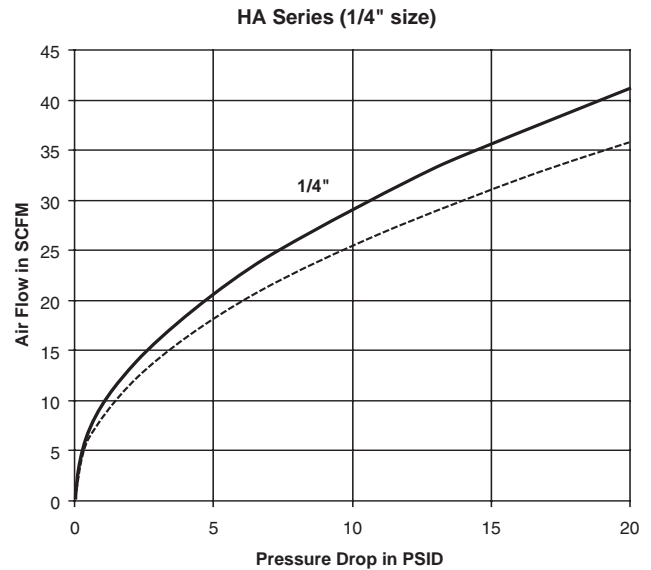

How To Order

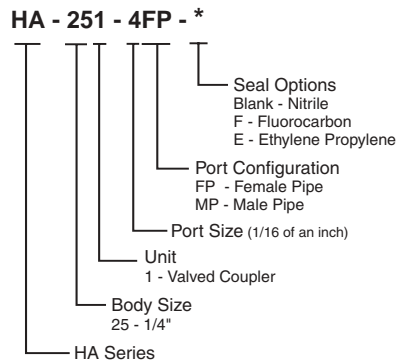

Body Size (in.)	NEW Part No. Brass	OLD Part No. Brass	Thread Size NPSF	Dimensions (in.)			Largest Diameter P/Piece	Wt. (LB)
				Overall Length	Hex Size	Hex Largest Diameter		
1/4	HA-251-4FP	C50A02-4-4	1/4-18	2.11	0.81	1.01	0.26	
1/4	HA-251-6FP	C50A02-4-6	3/8-18	2.14	0.81	1.01	0.27	

Body Size (in.)	NEW Part No. Brass	OLD Part No. Brass	Thread Size NPSF	Dimensions (in.)			Largest Diameter P/Piece	Wt. (LB)
				Overall Length	Hex Size	Hex Largest Diameter		
1/4	HA-251-4MP	C50A01-4-4	1/4-18	2.26	0.81	1.01	0.24	
1/4	HA-251-6MP	C50A01-4-6	1/4-18	2.26	0.81	1.01	0.24	

* See page A-15 for Nipples

Pneumatic Quick Couplings

General Purpose – Push-To-Connect

UC Series



Features

- The 1/4" UC Series Coupler will accept the industrial interchange, [(MIL-C-4109F) and (ANSI/(NFPA) T3.20.14-1990)], 10 Series (Tru-Flate) and the 50 series (ARO 210) style nipples.
- The coupler features automatic push-to-connect operation, high flow machined "window valve," corrosion resistant solid brass construction and a sleeve guard which helps prevent accidental disconnects and protects the sleeve from damage.
- While the best quick coupling performance is obtained by matching like series couplers and nipples, the universal coupler permits multiple series nipples to mate with one coupler.

Specifications

Body Size (in.)	1/4
Rated Pressure (PSI)	150
Temperature Range (Nitrile seal)	-40° to +250° F.
Locking Device	4 balls
Vacuum Service	Not Recommended

How to Order

UC - 251 - 4 FP - *

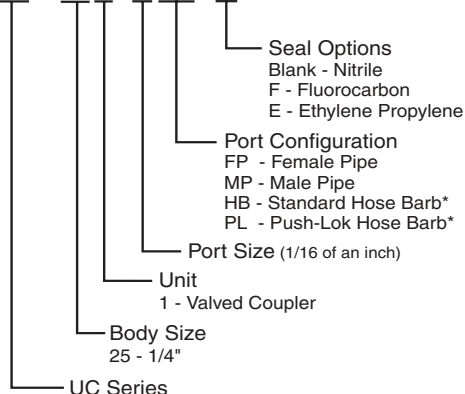

* Contact the Division for availability

Performance

UC Series Coupler (1/4" size)

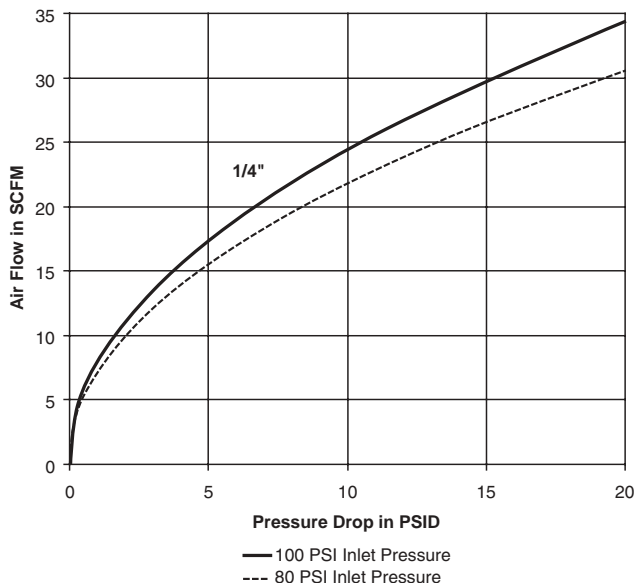

Couplers

Female Pipe Thread

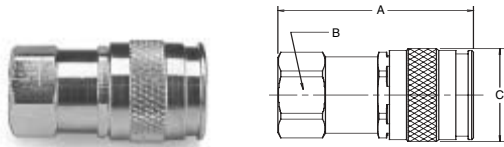

Body Size (in.)	New Part No. Brass	Old Pat No. Brass	Thread Size NPSF	Dimensions (in.)			Wt. (LB) P/Piece
				Overall Length	Hex Size	Largest Diameter	
				A	B	C	
1/4	UC-251-4FP	UC304F-4	1/4-18	2.06	0.81	0.98	0.23
1/4	UC-251-6FP	UC304F-6	3/8-18	2.21	0.81	0.98	0.23

Male Pipe Thread

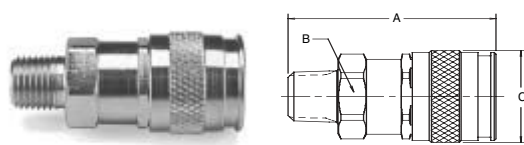

Body Size (in.)	New Part No. Brass	Old Part No. Brass	Thread Size NPTF	Dimensions (in.)			Wt. (LB) P/Piece
				Overall Length	Hex Size	Largest Diameter	
				A	B	C	
1/4	UC-251-4MP	UC304M-4	1/4-18	2.21	0.81	0.98	0.22
1/4	UC-251-6MP	UC304M-6	3/8-18	2.24	0.81	0.90	0.23

Contact the Division for Hose Barb and Push-Lok port availability



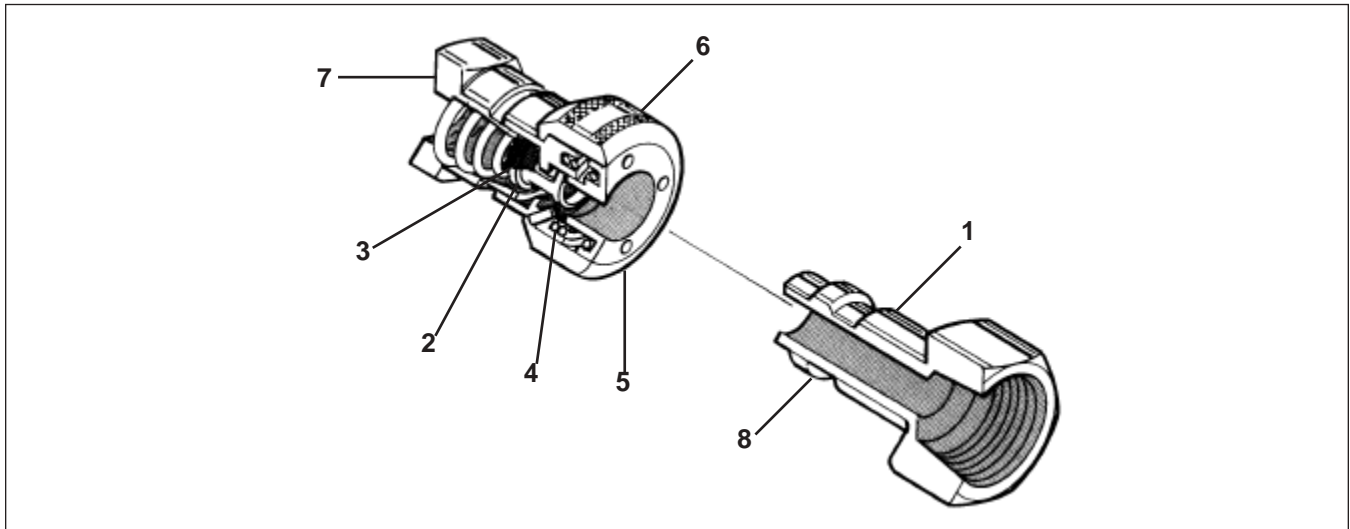

Component Part Features

1. Precision machining, hardened wear points* and solid bar stock construction provide long life even in rugged applications.
2. Tubular valve with large flow passages delivers high flow with minimum pressure drop for efficient performance. The tubular design provides 360° support for both the valve seal and the mating nipple for long service life.
3. Precision molded seals form a “bubble tight” seal for reliable operation within rated working pressures. Standard seal material is Nitrile. Ethylene Propylene, Fluorocarbon and Neoprene are available as options.
4. Locking pawls (pins) constructed of stainless steel create a durable locking mechanism that provides alignment and evenly distributes loads.
5. Push-to-connect design permits one-handed connection when the coupler half is rigidly mounted.
6. Knurling on the sleeve provides a gripping surface for ease of operation.
7. Wide range of end terminations are available to meet specific needs. Parker push type couplings are available with male pipe thread, female pipe thread, standard hose barb, and Push-Lok hose barb**.
8. Parker 30 Series couplings mate with industrial interchange design nipples. See Table of Contents.

* steel nipples only

** Push-Lok hose barbs are designed for use with Parker Push-Lok hose and do not require clamps.

Pneumatic Quick Couplings

General Purpose – Push-To-Connect 30 Series Industrial Interchange



Features

- Parker 30 Series couplers are designed for rigid mounting that allows a simple push-to-connect operation.
- Constructed of a solid brass body and a steel valve, 30 Series couplers are noted for their high flow capability, reliability and rugged design.
- Parker 30 Series couplers accept industrial interchange nipples manufactured by Parker and other manufacturers.
- Standard seal material is Nitrile. See Ordering Information at the beginning of Section A and the Fluid Compatibility Chart at the end of this catalog for optional materials.

Specifications

Body Size (in.)	1/4	3/8	1/2	3/4
Rated Pressure (PSI)	300	300	300	300
Temperature Range (Std. seals)*	-40° to +250° F.			
Locking Device	3 pawls	4 pawls	5 pawls	6 pawls
Vacuum Data (inches Hg)	Not recommended			
Disconnected (coupler only)	Not recommended			
Connected	27.4	27.4	27.4	27.4

* See Coupling Selection and Ordering Guide for Optional Seals.

Repair Kits

Body Size	Seal Material	Part No.
1/4	Nitrile	21K
1/4	Ethylene Propylene	21KW
1/4	Fluorocarbon	21KY
3/8	Nitrile	14K
3/8	Ethylene Propylene	14KW
3/8	Fluorocarbon	14KY
1/2	Nitrile	16K
1/2	Ethylene Propylene	16KW
1/2	Fluorocarbon	16KY
3/4	Nitrile	38K
3/4	Ethylene Propylene	38KW
3/4	Fluorocarbon	38KY

How to Order Information

Available with Sleeve-Lok (See Coupler Options Section). To order, add the suffix “-SL” to part number, Example: B33-SL.

Brass valves are available for extra corrosion resistance. To specify a brass valve, add the suffix “N” to the regular part number. Example: B33N. A brass valve should be used for corrosive applications where steel parts are not suitable. Consult the factory for specific recommendations.

Operation

Push type couplings feature one handed “automatic” connection by pushing the nipple into the coupler—provided the coupler half is firmly mounted.

The locking mechanism of Parker 30 Series couplers consists of pawls (or pins) which act directly on the sleeve, thereby causing the sleeve to automatically retract when the mating nipple is inserted.

Sleeve must be manually retracted to remove the nipple.

30 Series couplings are push type Single Shut-Off couplings.

Performance

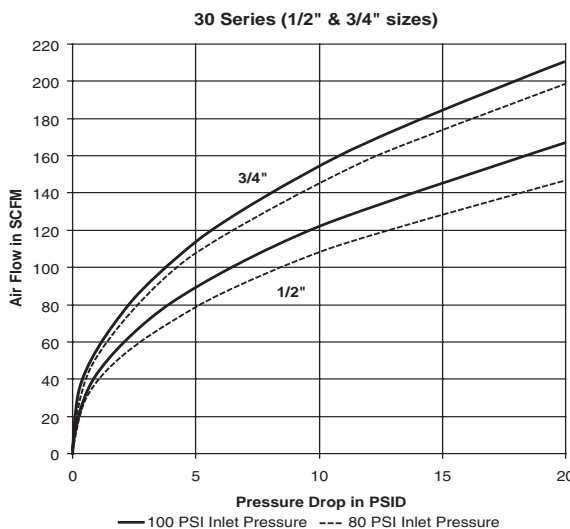
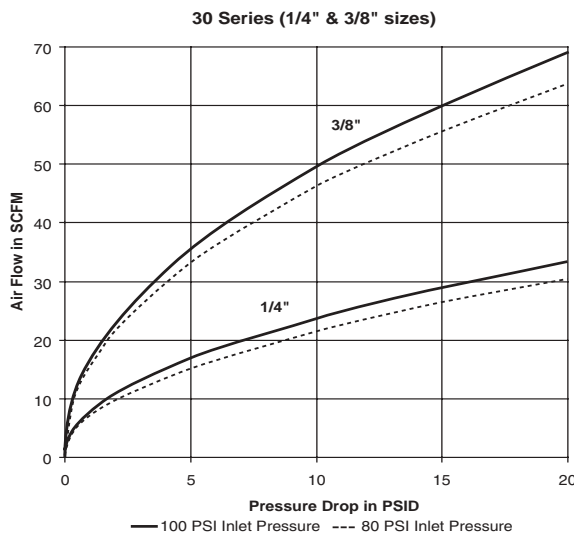

Couplers

Female Pipe Thread

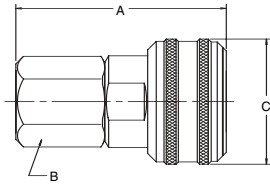

Body Size (in.)	Part No. Brass	Thread Size NPTF	Dimensions (in.)			Wt. (LB) P/Piece
			Overall Length	Hex Size	Largest Diameter	
			A	B	C	
1/4	B33A	1/8-27	1.96	0.75	1.20	0.30
1/4	B33	1/4-18	1.96	0.75	1.20	0.28
1/4	B33E	3/8-18	2.03	0.81	1.20	0.30
3/8	B35C	1/4-18	2.26	0.88	1.39	0.42
3/8	B35	3/8-18	2.33	0.88	1.39	0.42
3/8	B35F	1/2-14	2.57	1.00	1.39	0.46
1/2	B37E	3/8-18	2.76	1.00	1.52	0.56
1/2	B37	1/2-14	3.00	1.00	1.52	0.66
1/2	B37G	3/4-14	3.12	1.25	1.52	0.73
3/4	B39F	1/2-14	2.85	1.31	1.90	0.15
3/4	B39	3/4-14	2.99	1.31	1.90	1.10
3/4	B39J	1-11 1/2	3.18	1.56	1.90	1.24

Male Pipe Thread

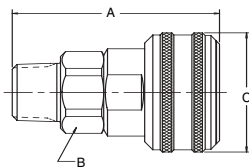

Body Size (in.)	Part No. Brass	Thread Size NPTF	Dimensions (in.)			Wt. (LB) P/Piece
			Overall Length	Hex Size	Largest Diameter	
			A	B	C	
1/4	B32A	1/8-27	2.03	0.75	1.20	0.27
1/4	B32	1/4-18	2.18	0.75	1.20	0.28
1/4	B32E	3/8-18	2.18	0.75	1.20	0.28
3/8	B34C	1/4-18	2.38	0.88	1.39	0.36
3/8	B34	3/8-18	2.44	0.88	1.39	0.39
3/8	B34F	1/2-14	2.57	0.88	1.39	0.41
1/2	B36E	3/8-18	2.92	1.00	1.52	0.58
1/2	B36	1/2-14	3.09	1.00	1.52	0.61
1/2	B36G	3/4-14	3.12	1.13	1.52	0.67
3/4	B38	3/4-14	2.95	1.31	1.90	0.91
3/4	B38J	1-11 1/2	3.12	1.31	1.90	0.99

Pneumatic Quick Couplings

General Purpose – Push-To-Connect 30 Series Industrial Interchange

Couplers

Standard Hose Barb

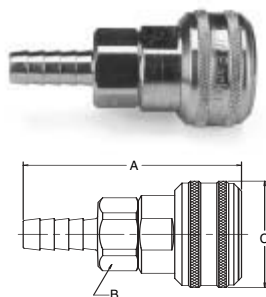

Body Size (in.)	Part No. Brass	Hose I.D.	Dimensions (in.)			Wt. (LB) P/Piece
			Overall Length	Hex Size	Largest Diameter	
			A	B	C	
1/4	B30-3B	1/4	2.62	0.75	1.20	0.27
1/4	B30-4B	5/16	2.62	0.75	1.20	0.27
1/4	B30-5B	3/8	2.62	0.75	1.20	0.28
3/8	B34-5B	3/8	2.85	0.88	1.39	0.39
3/8	B34-6B	1/2	2.85	0.88	1.39	0.41
1/2	B36-6B	1/2	3.33	1.00	1.52	0.59
1/2	B36-7B	3/4	3.86	1.00	1.52	0.65
3/4	B38-7B	3/4	3.69	1.31	1.90	0.93
3/4	B38-8B	1	3.93	1.31	1.90	1.03

Push-Lok Hose Barb*

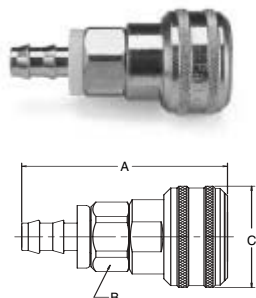

Body Size (in.)	Part No. Brass	Hose I.D.	Dimensions (in.)			Wt. (LB) P/Piece
			Overall Length	Hex Size	Largest Diameter	
			A	B	C	
1/4	B30-3BP	1/4	2.45	0.75	1.20	0.27
1/4	B30-5BP	3/8	2.60	0.75	1.20	0.29
3/8	B34-5BP	3/8	2.82	0.88	1.39	0.40
1/2	B36-6BP	1/2	3.46	1.00	1.52	0.56

* Push-Lok hose barbs are designed for use with Parker Push-Lok hose and do not require clamps.



Specification

Body Size (in.)	1/4	1/2
Rated Pressure (PSI)	300	300
Temperature Range (Nitrile seal)	-40° F to +250° F.	
Locking Device	CAM	
Vacuum Service	Not Recommended	

Features

- Push-to-Connect design for easy one hand operation.
- A variety of port configurations are available to meet specific needs.
- Standard Seals are Nitrile.
- Constructed of Zinc bodies and Zinc plated steel sleeves and nipples.
- Interchanges with Schrader Twist-Lock style couplings.

Operation

- Engineered for speedy coupling and uncoupling. To lock – push in; to unlock – give the coupler sleeve a 1/8 turn. Designed to protect against accidental uncoupling.

How To Order

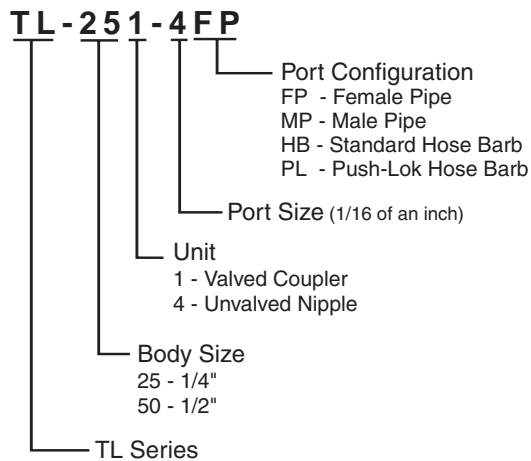

Performance

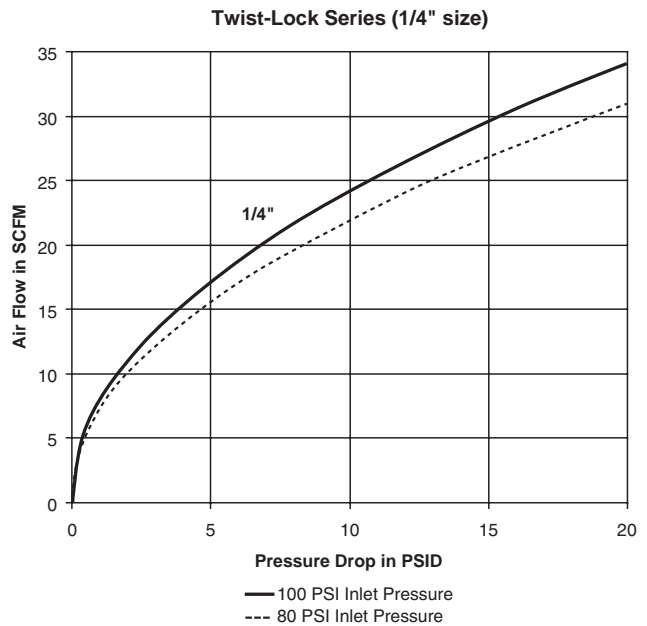

Pneumatic Quick Couplings

General Purpose – Push-To-Connect Twist-Lock

Couplers

Female Thread

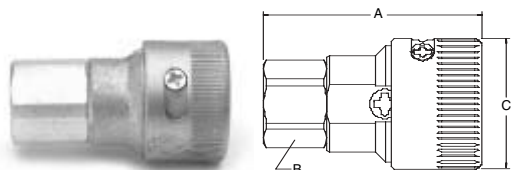

Body Size (in.)	NEW Part No. Steel	OLD Part No. Steel	Thread Size NPT	Dimensions (in.)			Wt. (LB) P/Piece
				Overall Length	Hex Size	Largest Diameter	
				A	B	C	
1/4	TL-251-4FP	8052-0319	1/4-18	2.01	0.75	1.12	0.21
1/2	TL-501-6FP	1095-0040	3/8-18	2.19	1.13	1.50	0.44
1/2	TL-501-8FP	1461-0070	1/2-14	2.50	1.13	1.50	0.44
1/2	TL-501-12FP	1462-0040	3/4-14	2.56	1.13	1.50	0.44

Male Thread

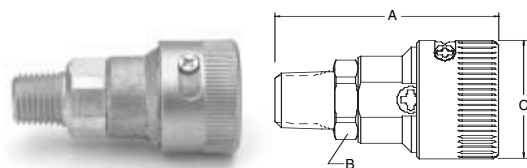

Body Size (in.)	NEW Part No. Steel	OLD Part No. Steel	Thread Size NPT	Dimensions (in.)			Wt. (LB) P/Piece
				Overall Length	Hex Size	Largest Diameter	
				A	B	C	
1/4	TL-251-4MP	3060-0109	1/4-18	2.23	0.75	1.12	0.21
1/4	TL-251-6MP	3061-0109	3/8-18	2.26	0.75	1.12	0.22
1/2	TL-501-6MP	3080-0020	3/8-18	2.31	1.13	1.50	0.39
1/2	TL-501-8MP	3081-0020	1/2-14	2.75	1.13	1.50	0.40

Nipples

Female Thread

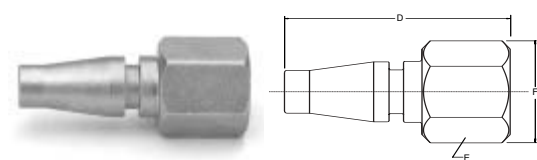

Body Size (in.)	NEW Part No. Steel	OLD Part No. Steel	Thread Size NPT	Dimensions (in.)			Wt. (LB) P/Piece
				Overall Length	Hex Size	Largest Diameter	
				D	E	F	
1/4	TL-254-2FP	2047-0010	1/8-27	1.53	0.56	0.65	0.04
1/4	TL-254-4FP	8278-0050	1/4-18	1.81	0.69	.79	0.07
1/2	TL-504-4FP	1261-0020	1/4-18	1.68	0.69	0.80	0.14
1/2	TL-504-6FP	1096-0010	3/8-18	1.84	0.88	1.01	0.14

Male Thread

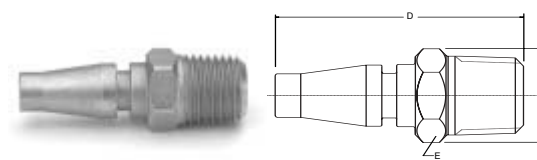

Body Size (in.)	NEW Part No. Steel	OLD Part No. Steel	Thread Size NPT	Dimensions (in.)			Wt. (LB) P/Piece
				Overall Length	Hex Size	Largest Diameter	
				D	E	F	
1/4	TL-254-2MP	8051-0010	1/8-27	1.65	0.56	0.65	0.05
1/4	TL-254-4MP	8050-0110	1/4-18	1.75	0.56	0.65	0.05
1/2	TL-504-4MP	8624-0070	1/4-18	1.87	0.69	0.80	0.12
1/2	TL-504-6MP	1095-0020	3/8-18	1.93	0.69	0.80	0.12
1/2	TL-504-8MP	1461-0050	1/2-14	2.16	0.88	1.01	0.13
1/2	TL-504-12MP	1462-0100	3/4-14	2.16	1.06	1.22	0.14

Standard Hose Barb

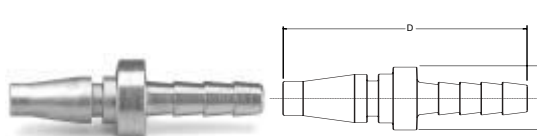

Body Size (in.)	NEW Part No. Steel	OLD Part No. Steel	Thread Size NPT	Dimensions (in.)		Wt. (LB) P/Piece
				Overall Length	Largest Diameter	
				D	F	
1/4	TL-254-4HB	8787-0040	1/4	1.83	0.50	0.04
1/4	TL-254-6HB	8788-0030	3/8	1.83	0.50	0.06
1/2	TL-504-4HB	2123-0030	1/4	2.31	0.80	0.10
1/2	TL-504-6HB	1097-0010	3/8	2.28	0.69	0.11
1/2	TL-504-8HB	1098-0010	1/2	2.28	0.81	0.12



Features

- Standard style Tool-Mate couplers are lightweight, easy to operate, and non-marring with easy, push-to-connect action.
- Couplers are constructed of Polyamide material; springs, balls, and pins are stainless steel; and locking fingers are made of polyacetate.
- PBH Tool-Mate Series is built to the Industrial Interchange profile identifiable with a Yellow ring around the body.
- PER Tool-Mate Series is designed to use with Parker's high flow RF Series nipples and is identifiable with a Green ring around the body.
- Grey body designates standard non-venting style coupler.

Operation

- Push-to-Connect design for easy one hand operation.
- Pull in the direction of the arrow indicated on the body of the coupler to release the nipple.

Specifications

Body Size	1/4"	3/8"
Rated Pressure	300	300
Temperature Range (°F)	0 to 160	0 to 160
Vacuum Service	Not Recommended	

How To Order

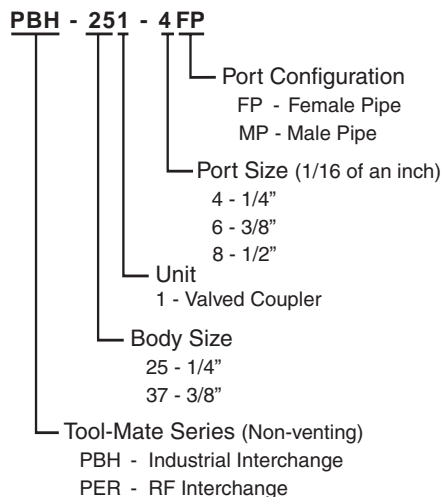

Performance

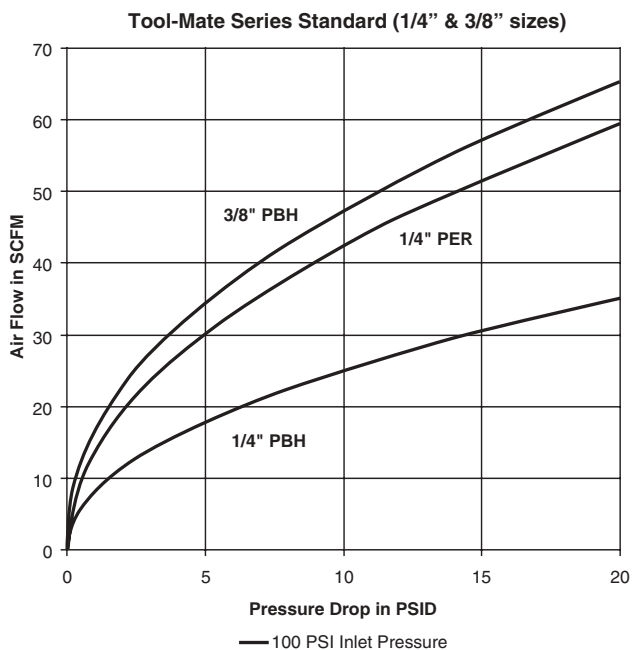

Pneumatic Quick Couplings

Special Purpose – Standard - Non Marring Tool-Mate Series

Industrial Interchange

Female Pipe Thread

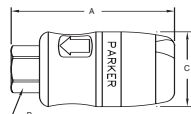

Body Size (in.)	Part No.	Thread Size NPTF	Overall Length	Hex Size	Largest Diameter	Wt. (LB) P/Piece
			A	B	C	
1/4"	PBH-251-4FP	1/4-18	2.60	0.67	1.19	0.13
1/4"	PBH-251-6FP	3/8-18	2.67	0.91	1.19	0.15
3/8"	PBH-371-4FP	1/4-18	2.95	0.67	1.38	0.21
3/8"	PBH-371-6FP	3/8-18	2.95	0.83	1.38	0.20
3/8"	PBH-371-8FP	1/2-14	3.17	0.99	1.38	0.22

Male Pipe Thread

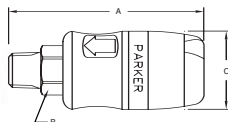

Body Size (in.)	Part No.	Thread Size NPTF	Overall Length	Hex Size	Largest Diameter	Wt. (LB) P/Piece
			A	B	C	
1/4"	PBH-251-4MP	1/4-18	2.97	0.67	1.19	0.14
1/4"	PBH-251-6MP	3/8-18	2.99	0.91	1.19	0.19
3/8"	PBH-371-4MP	1/4-18	3.39	0.83	1.38	0.23
3/8"	PBH-371-6MP	3/8-18	3.39	0.83	1.38	0.23

RF Interchange

Female Pipe Thread

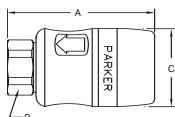

Body Size (in.)	Part No.	Thread Size NPTF	Overall Length	Hex Size	Largest Diameter	Wt. (LB) P/Piece
			A	B	C	
1/4"	PER-251-4FP	1/4-18	2.83	0.83	1.25	0.17
1/4"	PER-251-6FP	3/8-18	2.83	0.83	1.25	0.15

Male Pipe Thread

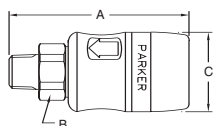

Body Size (in.)	Part No.	Thread Size NPTF	Overall Length	Hex Size	Largest Diameter	Wt. (LB) P/Piece
			A	B	C	
1/4"	PER-251-4MP	1/4-18	2.36	0.83	1.25	0.19
1/4"	PER-251-6MP	3/8-18	2.40	0.83	1.25	0.18

Pneumatic Quick Couplings

Special Purpose – Exhaust - Non Marring Tool-Mate Series



Features

- Exhaust style Tool-Mate couplers are lightweight, easy to operate, and non-marring with easy, push-to-connect action and one-handed disconnection.
- Couplers are constructed of black Polyamide material; springs, balls, and pins are stainless steel in the PES series and 1/2" PBS series; and locking fingers in the PBS series are made of polyacetate. End ports are galvanized steel.
- PBS Tool-Mate Series is built to the Industrial Interchange profile identifiable with a Yellow ring around the body.
- PES Tool-Mate Series is designed for use with high flow RF Series nipples and is identifiable with a Green ring around the body.
- Exhaust style Tool-Mate couplers meet the ISO 4414 specification to allow trapped air pressure to be vented prior to disconnection.
- Black body designates exhaust style coupler.

Specifications

Body Size	1/4"	3/8"	1/2"
Rated Pressure	300	300	300
Temperature Range (°F)	0 to 160	0 to 160	0 to 160
Vacuum Service	Not Recommended		

Operation

- Push-to-Connect design for easy one hand operation.
- Pull the body in the direction of the arrow marked 1, this will safely vent the downstream pressure.
- Push the body in the direction of arrow 2 to disconnect at 0 pressure.

How To Order

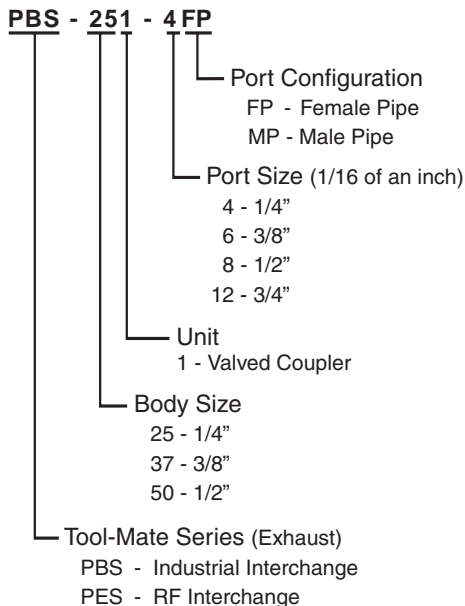

Performance

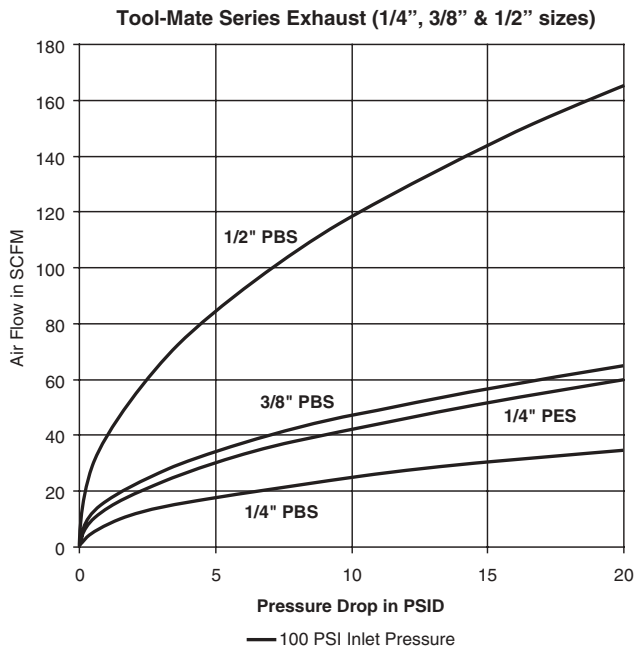

Pneumatic Quick Couplings

Special Purpose – Exhaust - Non Marring Tool-Mate Series

Exhaust Industrial Interchange

Female Pipe Thread

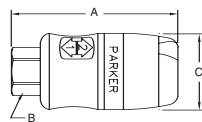

Body Size (in.)	Part No	Thread Size NPTF	Overall Length	Hex Size	Largest Diameter	Wt. (LB) P/Piece
			A	B	C	
1/4"	PBS-251-4FP	1/4-18	2.60	0.67	1.19	0.13
1/4"	PBS-251-6FP	3/8-18	2.67	0.91	1.19	0.15
3/8"	PBS-371-6FP	3/8-18	2.95	0.82	1.38	0.20
3/8"	PBS-371-8FP	1/2-14	3.17	0.99	1.38	0.22
1/2"	PBS-501-6FP	3/8-18	3.25	1.18	1.62	0.50
1/2"	PBS-501-8FP	1/2-14	3.36	1.18	1.62	0.50
1/2"	PBS-501-12FP	3/4-14	3.66	1.18	1.62	0.50

Male Pipe Thread

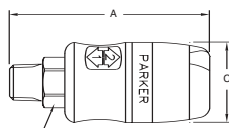

Body Size (in.)	Part No.	Thread Size NPTF	Overall Length	Hex Size	Largest Diameter	Wt. (LB) P/Piece
			A	B	C	
1/4"	PBS-251-4MP	1/4-18	2.97	0.67	1.19	0.14
1/4"	PBS-251-6MP	3/8-18	2.99	0.91	1.19	0.19
3/8"	PBS-371-6MP	3/8-18	3.39	0.82	1.38	0.23
3/8"	PBS-371-8MP	1/2-18	3.39	0.91	1.38	0.28
1/2"	PBS-501-8MP	1/2-18	3.70	1.18	1.62	0.50

Exhaust RF Interchange

Female Pipe Thread

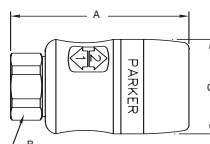

Body Size (in.)	Part No.	Thread Size NPTF	Overall Length	Hex Size	Largest Diameter	Wt. (LB) P/Piece
			A	B	C	
1/4"	PES-251-4FP	1/4-18	2.83	0.83	1.25	0.17
1/4"	PES-251-6FP	3/8-18	2.83	0.83	1.25	0.15

Male Pipe Thread

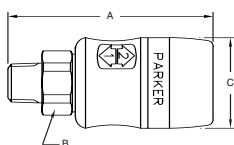

Body Size (in.)	Part No.	Thread Size NPTF	Overall Length	Hex Size	Largest Diameter	Wt. (LB) P/Piece
			A	B	C	
1/4"	PES-251-4MP	1/4-18	2.36	0.83	1.25	0.19
1/4"	PES-251-6MP	3/8-18	2.40	0.83	1.25	0.18



Operation

Parker E-z-mate couplings combine push-to-connect, exhaust-style action with a self-locking valve sleeve to guard against accidental disconnection. Simply follow the direction of the On-Off arrow stamped on the yellow chromate valve sleeve. It's that easy.

To connect, push the nipple into the coupler. The black locking sleeve automatically slides forward securely locking the nipple in place. No air is allowed to flow through the coupling at this point. The yellow chromate valve sleeve is then rotated clockwise (when viewed from the coupler port end) to open flow and automatically engage the sleeve-lock mechanism.

To disconnect, rotate the valve sleeve counter clockwise (when viewed from the coupler end). The flow of air through the coupling will be shut off and all downstream air is vented to the atmosphere. The locking sleeve may now be retracted and the nipple removed. Lubricate sleeve as part of periodic maintenance to coupler.

Specifications

Body Size (in.)	1/4	3/8	1/2	3/4
Rated Pressure (PSI)	300	300	300	300
Temperature Range (std seals)	-40° to +250° F.			
Locking Device	4 balls	4 balls	6 balls	8 balls
Force required to Connect (lbs)	Less than 10			
Vacuum Service	Not recommended			

How To Order

EZ - 251 - 4 FP

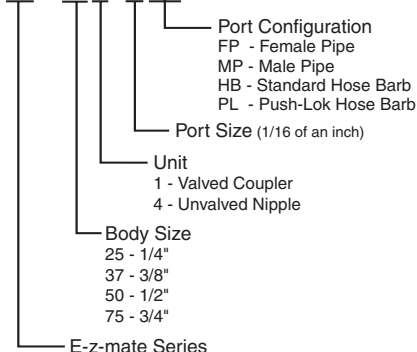

Features

- Parker's E-z-mate is an exhaust type coupler that is designed to exhaust air pressure prior to the disconnection process.
- The valve sleeve acts as an integral shut-off valve that allows connection and disconnection at zero pressure. When the sleeve is moved to shut off air flow, it automatically vents downstream allowing for disconnection at zero pressure and eliminating the risk of "hose whip."
- Meets ISO 4414 requirements for a controlled pressure release system.
- Built-in sleeve-lok mechanically locks the valve sleeve to help prevent accidental disconnects.
- Proven ball locking mechanism evenly distributes load to resist wear and provide positive connections. The ball locking mechanism also provides accurate alignment and allows a swiveling action to reduce hose torque.
- O-ring interface seal assures "bubble tight" seal and long service life.
- E-z-mate Series couplings use industrial interchange nipples.
- Brass versions available. Contact the division for availability.

Performance

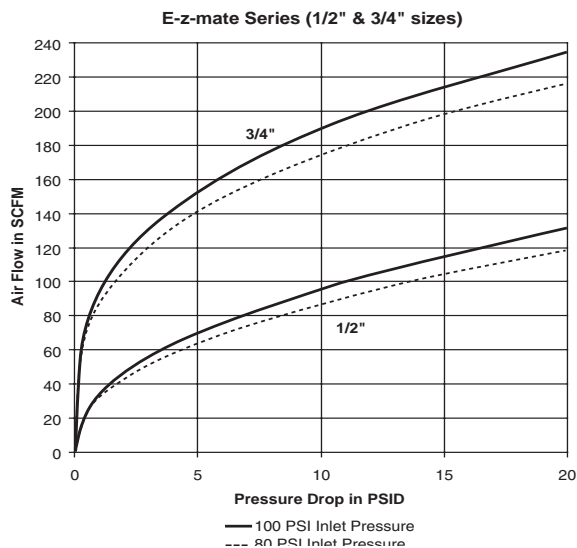
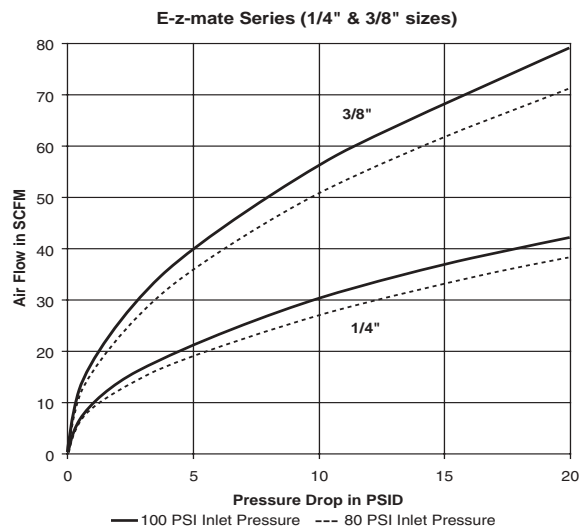

Pneumatic Quick Couplings

Special Purpose – Exhaust - Steel E-z-mate Series Industrial Interchange

Couplers

Female Pipe Thread

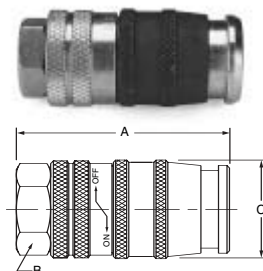

Body Size (in.)	New Part No. Steel	Old Part No. Steel	Thread Size NPTF	Dimensions (in.)			Wt. (LB) P/Piece
				Overall Length	Hex Size	Largest Diameter	
				A	B	C	
1/4	EZ-251-4FP	EZ304F-4T	1/4-18	2.25	0.75	1.00	0.25
1/4	EZ-251-6FP	EZ304F-6T	3/8-18	2.68	0.88	1.01	0.29
3/8	EZ-371-6FP	EZ306F-6T	3/8-18	2.53	0.88	1.18	0.38
3/8	EZ-371-8FP	EZ306F-8T	1/2-14	3.00	1.12	1.30	0.50
1/2	EZ-501-8FP	EZ308F-8T	1/2-14	3.01	1.12	1.38	0.65
1/2	EZ-501-12FP	EZ308F-12T	3/4-14	3.44	1.38	1.59	0.70
3/4	EZ-751-12FP	EZ312F-12T	3/4-14	3.01	1.38	1.57	0.76
3/4	EZ-751-16FP	EZ312F-16T	1-11 1/2	3.52	1.56	1.80	0.92

Male Pipe Thread

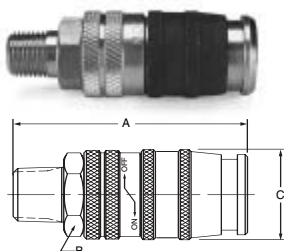

Body Size (in.)	New Part No. Steel	Part No. Steel	Thread Size NPTF	Dimensions (in.)			Wt. (LB) P/Piece
				Overall Length	Hex Size	Largest Diameter	
				A	B	C	
1/4	EZ-251-4MP	EZ304M-4T	1/4-18	2.85	0.75	1.00	0.30
1/4	EZ-251-6MP	EZ304M-6T	3/8-18	2.87	0.75	1.00	0.31
3/8	EZ-371-6MP	EZ306M-6T	3/8-18	3.10	0.88	1.18	0.44
1/2	EZ-501-8MP	EZ308M-8T	1/2-14	3.62	1.12	1.38	0.73
3/4	EZ-751-12MP	EZ312M-12T	3/4-14	3.70	1.38	1.57	0.90

Standard Hose Barb

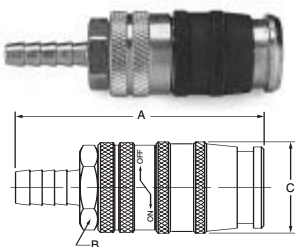

Body Size (in.)	New Part No. Steel	Old Part No. Steel	Hose I.D.	Dimensions (in.)			Wt. (LB) P/Piece
				Overall Length	Hex Size	Largest Diameter	
				A	B	C	
1/4	EZ-251-4HB	EZ304HB-4T	1/4	3.20	0.75	1.00	0.28
1/4	EZ-251-6HB	EZ304HB-6T	3/8	3.20	0.75	1.00	0.29
3/8	EZ-371-6HB	EZ306HB-6T	3/8	3.43	0.88	1.18	0.42
1/2	EZ-501-8HB	EZ308HB-8T	1/2	4.06	1.12	1.40	0.70

Push-Lok Hose Barb*

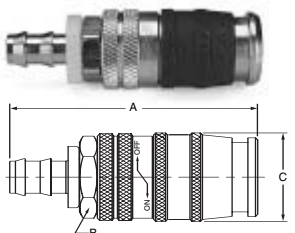

Body Size (in.)	New Part No. Steel	Old Part No. Steel	Hose I.D.	Dimensions (in.)			Wt. (LB) P/Piece
				Overall Length	Hex Size	Largest Diameter	
				A	B	C	
1/4	EZ-251-4PL	EZ304PL-4T	1/4	3.03	0.75	1.00	0.28
1/4	EZ-251-6PL	EZ304PL-6T	3/8	3.18	0.75	1.00	0.29
3/8	EZ-371-6PL	EZ306PL-6T	3/8	3.38	0.88	1.18	0.42
1/2	EZ-501-8PL	EZ308PL-8T	1/2	3.91	1.12	1.38	0.70

* Push-Lok hose barbs are designed for use with Parker Push-Lok hose and do not require clamps.

Note: See Table of Contents for Industrial Interchange nipples used with E-z-mate Series couplers.



Features

- Parker CJ series couplings feature a unique design that allows for simple push-to connect operation yet requires a two step process to disconnect. To disconnect, the nipple must be pushed into the coupler before the coupler sleeve can be retracted.
- This sleeve locking feature greatly reduces the potential of accidental disconnects in applications where connection integrity is of primary importance.
- Typical uses include rescue and breathing air equipment in addition to general pneumatic applications.
- Couplers feature solid brass construction, nickel plating, sleeve guard, high flow window valve, stainless steel springs and locking balls.
- Nitrile seals are standard with Ethylene Propylene seals available by adding an “E” suffix to the part number. Example: CJ-251-4MP-E.
- Nipples feature heat treated solid steel bar stock construction and nickel plating. CJ series couplings are available in 1/4" body size with 1/4" and 3/8" male pipe, female pipe, and hose barb ports.
- Interchanges with CEJN 342/343 series.

Specifications

Body Size (in.)	1/4
Rated Pressure (PSI)	150
Temperature Range (Std. Seals)	-40° to +250° F.
Locking Device	4 balls
Vacuum Service	Not Recommended

Performance

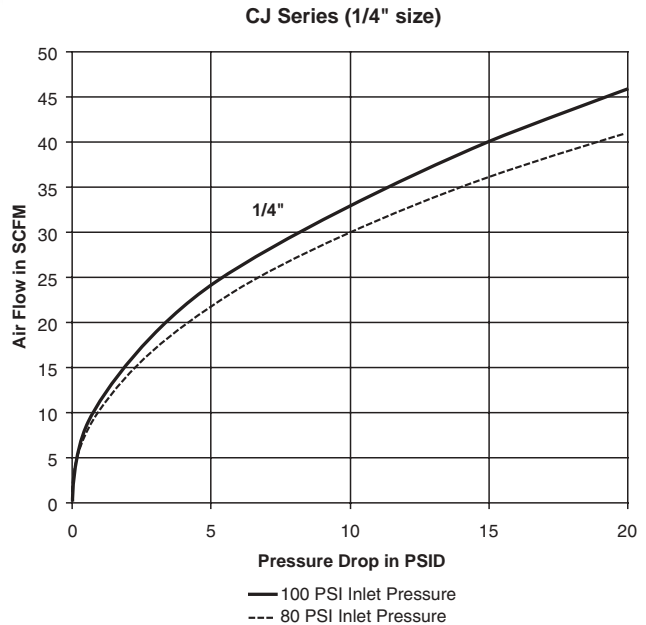

How To Order

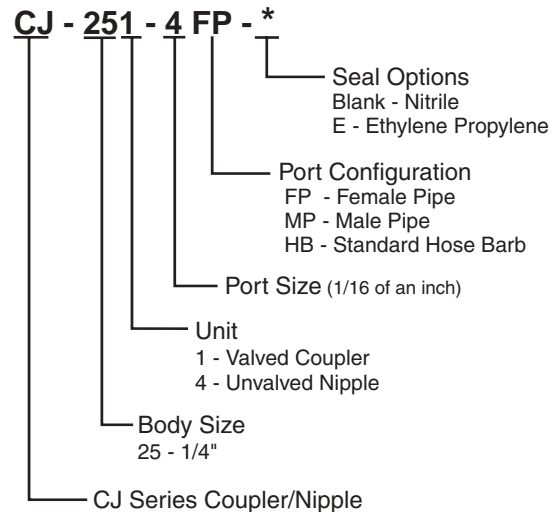

Pneumatic Quick Couplings

Special Purpose – Breathing Air CJ Series

Couplers

Female Pipe

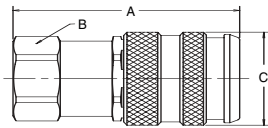
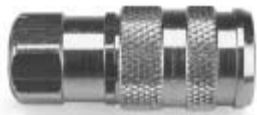

Body Size (in.)	New Part No. Brass	Part No. Brass	Thread Size NPSF	Dimensions (in.)			Wt. (LB) P/Piece
				Overall Length	Hex Size	Largest Diameter	
				A	B	C	
1/4	CJ-251-4FP	CJ304F-4	1/4-18	2.40	0.81	0.99	0.28
1/4	CJ-251-6FP	CJ304F-6	3/8-18	2.55	0.81	0.99	0.30

Male Pipe

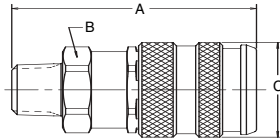

Body Size (in.)	New Part No. Brass	Old Part No. Brass	Thread Size NPTF	Dimensions (in.)			Wt. (LB) P/Piece
				Overall Length	Hex Size	Largest Diameter	
				A	B	C	
1/4	CJ-251-4MP	CJ304M-4	1/4-18	2.55	0.81	0.99	0.26
1/4	CJ-251-6MP	CJ304M-6	3/8-18	2.58	0.81	0.99	0.27

Hose Barb

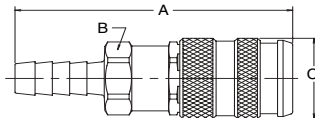

Body Size (in.)	New Part No. Brass	Old Part No. Brass	Hose I.D.	Dimensions (in.)			Wt. (LB) P/Piece
				Overall Length	Hex Size	Largest Diameter	
				A	B	C	
1/4	CJ-251-4HB	CJ304HB-4	1/4	3.02	0.81	0.99	0.25
1/4	CJ-251-6HB	CJ304HB-6	3/8	3.02	0.81	0.99	0.25

Nipples

Female Pipe

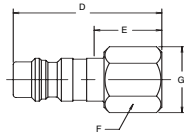

Body Size (in.)	New Part No. Steel	Old Part No. Steel	Thread Size NPTF	Overall Length	Dimensions (in.)			Wt. (LB) P/Piece
					Exposed Length*	Hex Size	Largest Diameter	
					D	E	F	G
1/4	CJ-254-4FP	CJ604F-4	1/4-18	1.60	0.74	0.62	0.72	0.06
1/4	CJ-254-6FP	CJ604F-6	3/8-18	1.68	0.80	0.81	0.94	0.09

* This dimension represents the portion that is exposed when a nipple is inserted into a Parker CJ Series coupler.

Male Pipe

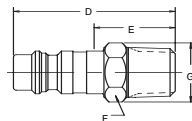

Body Size (in.)	New Part No. Steel	Old Part No. Steel	Thread Size NPTF	Overall Length	Dimensions (in.)			Wt. (LB) P/Piece
					Exposed Length*	Hex Size	Largest Diameter	
					D	E	F	G
1/4	CJ-254-4MP	CJ604M-4	1/4-18	1.71	0.89	0.56	0.72	0.06
1/4	CJ-254-6MP	CJ604M-6	3/8-18	1.76	0.92	0.69	0.94	0.07

* This dimension represents the portion that is exposed when a nipple is inserted into a Parker CJ Series coupler.

Hose Barb

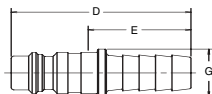

Body Size (in.)	New Part No. Steel	Part No. Steel	Hose I.D.	Dimensions (in.)			Wt. (LB) P/Piece
				Overall Length	Exposed Length*	Largest Diameter	
				D	E	G	
1/4	CJ-254-4HB	CJ604HB-4	1/4	1.83	0.96	0.50	0.04
1/4	CJ-254-6HB	CJ604HB-6	3/8	1.83	0.96	0.50	0.04

* This dimension represents the portion that is exposed when a nipple is inserted into a Parker CJ Series coupler.



Pneumatic Quick Couplings

Accessories Hose Fittings

Male Reusable Hose End

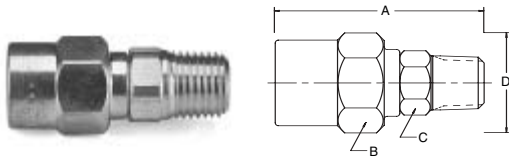

Part No. Brass	Hose I.D.	HOSE O.D.	Thread Size NPTF	Overall Length	Hex Size	Hex Size	Largest Diameter	Wt. (LB) P/Piece
				A	B	C	D	
330-C3	1/4	1/2	1/4	1.720	0.56	0.69	0.79	—
330-C5	1/4	9/16	1/4	1.720	0.56	0.75	0.87	—
330-C6	1/4	5/8	1/4	1.720	0.56	0.81	0.94	—
332-E6	3/8	5/8	1/4	2.095	0.56	0.88	1.01	—
332-E7	3/8	21/32	1/4	2.095	0.56	0.88	1.01	—
332-E8	3/8	11/16	1/4	2.095	0.56	0.88	1.01	—
332-E10	3/8	3/4	1/4	2.095	0.56	0.94	1.08	—

Female Hose Barb

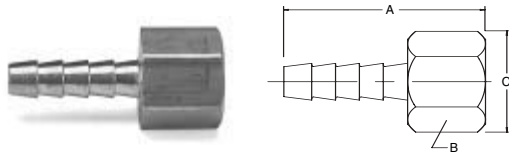

Part No. Brass	Hose I.D.	Thread Size NPTF	Overall Length	Hex Size	Largest Diameter	Wt. (LB) P/Piece
			A	B	C	
311	1/4	1/4	1.58	—	—	0.05
311-3/8	3/8	1/4	1.58	—	—	0.05

Male Hose Barb

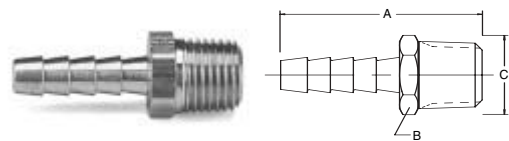

Part No.	Hose I.D.	Thread Size NPTF	Overall Length	Hex Size	Largest Diameter	Weight P/Piece
			A	B	C	
308	1/4	1/8	1.54	0.44	0.50	0.02
310	1/4	1/4	1.64	0.56	0.65	0.02
310-5/16	5/16	1/4	1.64	0.56	0.65	0.03
310-3/8	3/8	1/4	1.64	0.56	0.65	0.11
310-1/2	1/2	1/4	1.64	0.56	0.65	0.04
318	3/8	3/8	1.71	0.69	0.79	0.05
318-1/4	1/4	3/8	1.71	0.69	0.79	0.04
318-1/2	1/2	3/8	1.71	0.69	0.79	0.06
322	1/2	1/2	1.86	0.88	1.01	0.10
322-3/8	3/8	1/2	1.86	0.88	1.01	0.09
322-3/4	3/4	1/2	1.86	0.88	1.01	0.13

Brass Hose Splicer

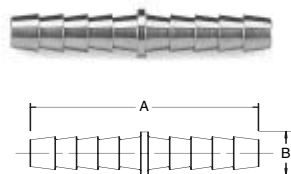

Part No. Brass	Hose I.D.	Overall Length	Largest Diameter	Wt. (LB) P/Piece
		A	B	
314	1/4	2.00	0.38	0.01
314-5/16	5/16	2.00	0.50	0.02
314-3/8	3/8	2.00	0.56	0.03

Pneumatic Quick Couplings

Accessories

Blow Guns (Controlled Pressure)

Features

- Parker Controlled Pressure Blow Guns meet OSHA requirements (section 29 CFR 1910.242 paragraph b), and directive #100-1. "Compressed air shall not be used for cleaning purposes except where reduced to less than 30 psi, and then only with effective chip guarding and personal protective equipment."
- Parker Controlled Pressure Blow Guns have a black epoxy coated zinc body and vented nozzles to prevent pressure build-up when dead ending occurs up to 150 psi.



Description

410-S – Parker Controlled Pressure Blow Guns features thumb lever valve actuator and brass nozzle. Inlet port is 1/4" NPT.

Specifications

Part No.	Maximum Pressure	Wt. (LB) P/Piece
410-S	150 PSI.	0.50
410-SV	150 PSI	0.53
415-S	150 PSI	0.48



410-SV – Parker Venturi Nozzle Controlled Pressure Blow Gun with thumb lever valve and large venturi side ports for high volume flow. Inlet port is 1/4" NPT.



415-S – Parker Controlled Pressure Blow Guns features push button valve actuator and brass nozzle. Inlet port is 1/4" NPT.



Part No. 400-S-TIP
Blow Gun
Replacement Tip

Accessories

Blow Guns (Full Pressure)

The following Parker Blow Guns must have a pressure regulator setting below 30 psi to conform to OSHA safety requirements 29 CFR 1910.242 Paragraph b.



Description

410 – Parker two way thumb lever valve has a zinc body with 1/4" NPT inlet and 1/8" NPSF outlet.

Specifications

Part No.	Maximum Pressure	Wt. (LB) P/Piece
410	150 PSI	0.48
410-N	150 PSI	0.51
415-N	150 PSI	0.49

Note: Standard Gun without nozzle.



410-N – Parker thumb lever style Blow Gun features a zinc body, brass nozzle, and 1/4" NPT female inlet.



415-N – Parker Blow Gun features a push button style actuator, zinc body with a brass nozzle and 1/4" NPT female inlet.

Pneumatic Quick Couplings

Accessories

BG Series



Description

Made from impact resistant plastic, BG Series blow guns are durable and versatile. Extended nozzles allow air to be directed where it is required. The pistol grip trigger allows greater control over the amount of air delivered. Combined, these two features provide superior performance in a light weight, ergonomically designed package.

Nozzles are available in short and extended versions and most models meet OSHA directives on the use of compressed air for cleaning purposes. OSHA directive #100-1 states that "when dead ending occurs a static pressure at the main orifice shall not exceed 30 psi." For those blow guns that do not meet this requirement, OSHA requires that "compressed air shall not be used for cleaning purposes except where reduced to less than 30 psi, and then only with effective chip guarding and personal protective equipment" (section 29 CFR 1910.242 paragraph b). Please refer to the blow gun descriptions below for compatibility with OSHA directive #100-1.

Nozzle configurations are designed for maximum flexibility. Applications with special requirements may find the BG443-NBL with a 1/8" NPT fitting convenient for adapting existing nozzles or extra-long extensions. For information on specials or made-to-order blow gun nozzles, please contact the Quick Coupling Division.

Features

- Easy to control variable flow pistol grip trigger.
- Nozzles available that meet OSHA requirements.
- Lightweight ergonomical design.
- Bodies are constructed of impact resistant plastic.

Specifications

Rated Pressure (PSI)	175 psi
Temperature Range	to 120° F
Inlet Port	1/4" NPTF

How to Order

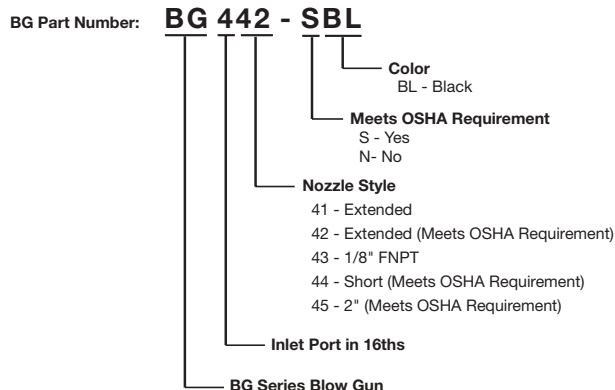

Part Number	Nozzle	Meets OSHA Requirements
BG441-NBL	Extended	No



Part Number	Nozzle	Meets OSHA Requirements
BG442-SBL	Extended	Yes



Part Number	Nozzle	Meets OSHA Requirements
BG443-NBL	1/8" Female NPT	No



Part Number	Nozzle	Meets OSHA Requirements
BG444-SBL	Vortec	Yes



Part Number	Nozzle	Meets OSHA Requirements
BG445-SBL	Two Inch	Yes*

* 90 PSI MAX Inlet

Pneumatic Quick Couplings

Accessories Two-Way Valves

Features

- Parker two-way valves are designed for use in air or liquid service.
- Bodies are constructed of black molded polypropylene.
- The valve cartridge components are machined from brass and stainless steel for corrosion resistance and long life.
- Nitrile stem seals are standard. Add suffix Y for optional fluorocarbon seal. Consult factory for price and delivery.

Specifications

Rated Pressure (PSI)	175 @ 70° F	120 @ 180° F
Temperature Range	-20° to 180° F	



Description

P410B – Two way valve with forward positioned lever handle. Inlet and outlet ports are 1/4" NPT.



P415B – Two way valve features push button style valve actuator. Inlet and outlet ports are 1/4" NPT.



P420B – Reverse oriented lever handle is used in carpet cleaning applications which utilize tube mounted valves. Inlet and outlet ports are 1/4".

Hydraulic Quick Couplings

Hydraulic Quick Couplings

Double Shut-Off and Straight-Thru Couplings

Parker hydraulic couplings have a wide variety of designs, each tailored to a particular application or use. This catalog is arranged according to those categories. In each section the construction of a specific design will be detailed. However, based on the valving of the coupling, hydraulic couplings generally fall into one of two groups, either Double Shut-Off or Straight-Thru.

Double Shut-Off couplings are used extensively when it is important to minimize fluid loss upon disconnection. Both halves of the coupler, the body and the nipple, contain shut-

off valves. These valves open automatically when the body and nipple are connected, and close automatically when the two halves are disconnected—keeping fluid loss to a minimum.

Parker Straight-Thru couplings have no valves in either half and are ideal for maximum flow application. Their smooth, open bore offers the lowest pressure drop of any quick disconnect coupling, and allows them to be thoroughly cleaned. Since there are no valves in either half, fluid flow should be shut off before the coupling is disconnected.

Rated Pressure

Rated pressure for the Parker hydraulic couplings range from 30 to 15,000 psi, depending on the coupling series, size and materials. Rated pressures as shown in this catalog are defined in the American National Standard Glossary of Terms for Fluid Power, ANSI/B93.2-1986, as “the qualified operating pressures which are recommended for a component or a system by the manufacturer.” Parker “Rated Pressures” have been established on the basis of laboratory tests which include, but are not limited to, static burst tests and multiple cycle impulse tests. System characteristics such as high cycling rates and high amplitude shocks either hydraulic or mechanical, can reduce the functioning life of a coupling,

even if the system’s nominal pressure falls within the rated pressure range of the coupling.

For assistance in analyzing your application, contact your nearest Parker sales office or the Quick Coupling Division in Minneapolis.

Refer to the Safety Guide at the end of this catalog for considerations when selecting a Quick Coupling.

Refer to the Fluid Compatibility Chart (note Table of Contents) for seal selection assistance for both Double Shut-Off and Straight-Thru couplings.

Checklist for Selecting Quick Couplings

- What are the functional requirements of the coupling?
- What is the maximum working pressure of the application?
- Which seals and body material are compatible with the system’s fluid?
- Is the application static or dynamic?
- What size coupler is required?
- What is the maximum pressure drop suitable for the application?
- Does the application require the ability to connect and disconnect under pressure?
- What is the media temperature and ambient temperature?
- What end configurations are required?
- Is an industry interchange coupler required?
- Is air inclusion and fluid loss a concern in the application?



Introduction	B-2	FH Series	B-31-32
Coupling Selection Guide	B-4	Couplers	B-32
General Purpose Couplings		Nipples	B-32
60 Series	B-5-8	FS Series	B-33-34
Couplers	B-7-8	Couplers	B-34
Nipples	B-7-8	Nipples	B-34
Repair Kits & Replacement Parts	B-8	Repair Kits	B-34
60 Series Steam	B-9	Connect Under Pressure Couplings	
Couplers	B-9	6100 Series	B-35-37
Nipples	B-9	Couplers	B-36-37
6600 Series	B-10-11	Nipples	B-37
Couplers	B-11	8200 Series	B-38-39
Nipples	B-11	Couplers	B-39
SM Series	B-12-13	Nipples	B-39
Couplers	B-13	9200 Series	B-40-41
Nipples	B-13	Couplers	B-41
HP Series	B-14-15	Nipples	B-41
Couplers	B-15	5000 Series	B-42-43
Nipples	B-15	Couplers	B-43
4000 Series	B-16-17	Nipples	B-43
Couplers	B-17	High Pressure Couplings	
Nipples	B-17	3000 Series	B-44-45
4200 Series	B-18-19	Couplers	B-45
Couplers	B-19	Nipples	B-45
Nipples	B-19	TC Series	B-46
Non-Spill Couplings		Couplers	B-46
NS Series	B-20-21	Nipples	B-46
Couplers	B-21	1141 Series	B-47
Nipples	B-21	Mold Coolant Line Couplings	
Adapters	B-22	Moldmate Series	B-48-52
FF Series	B-23-24	Couplers	B-49-50
Couplers	B-24	Sub Assemblies & Replacement Parts	B-50
Nipples	B-24	Nipples	B-51-52
FE Series	B-25-26	High Flow Couplings	
Couplers	B-26	ST Series	B-53-55
Nipples	B-26	Couplers	B-54
FEM Series	B-27-28	Nipples	B-55
Couplers	B-28	Water Service	B-56
Nipples	B-28	HO Series	B-57
FC Series	B-29	Special Purpose - Miniature	
Couplers	B-29	DM Series	B58-B59
Nipples	B-29	Dust Plugs and Dust Caps	B-60-62
FEC Series	B-30	Ordering Information	B-63
Couplers	B-30	Promotional Products-Keychains	B-64
Nipples	B-30		

Coupling Selection & Ordering Guide

Hydraulic Quick Couplings

B Hydraulics

	Valving	Body Size	Material* Br S S3 S6	Locking Mechanism	Std. Seal Material**	Temp Range**	Rated Pressure	
General Purpose								
60 Series	Poppet	1/8 - 2 1/2"	● ● ● ●	Ball	Nitrile	-40° to +250° F	1000 to 5000 PSI	
60 Series Steam	Poppet	1/4 to 1"	●	Ball	Ethylene Propylene	-65° to +400° F	100 PSI	
6600 Series	Poppet	1/4 to 1"	●	Ball	Nitrile	-40° to +250° F	4000 to 5000 PSI	
SM Series	Poppet	1/4 to 3/4"	●	Ball	Nitrile	-40° to +250° F	4500 to 6000 PSI	
HP Series	Poppet	1 to 1 1/2"	●	Ball	Nitrile	-40° to +250° F	5000 PSI	
4000 Series	Poppet/Ball	1/4 to 1"	●	Ball	Nitrile	-40° to +250° F	3000 PSI	
4200 Series	Poppet/Ball	3/8 to 1/2"	●	Ball	Nitrile	-40° to +250° F	3000 PSI	
Non-Spill								
NS Series	Flush Face	3/8 to 1"	●	Ball	Nitrile	-40° to +250° F	2500 PSI	
Adapter	Flush Face/Poppet	1/2"	●	Ball	Nitrile	-40° to +250° F	3000 to 3625 PSI	
FF Series	Flush Face	1/4 to 1"	●	Ball	Nitrile	-40° to +250° F	3000 to 5000 PSI	
FE Series	Flush Face	1/2 to 5/8"	●	Ball	Nitrile	-40° to +250° F	3625 PSI	
FEM Series	Flush Face	1/4 to 1"	●	Ball	Nitrile	-40° to +250° F	3000 to 5000 PSI	
FS Series	Flush Face	1/4 to 1"		●	Ball	Fluorocarbon	-15° to +400° F	2000 PSI
Non-Spill Connect Under Pressure								
FC Series	Flush Face	3/8 to 3/4"	●	Ball	Nitrile	-40° to +250° F	3000 PSI	
FEC Series	Flush Face	3/8 to 1"	●	Ball	Nitrile	-40° to +250° F	3000 PSI	
6100 Series	Flush Face	3/4 to 1 1/2"	●	Threads	Nitrile	-40° to +250° F	2000 to 3000 PSI	
Connect Under Pressure								
8200 Series	Poppet	1/2"	●	Ball	Nitrile	-40° to +250° F	3000 PSI	
9200 Series	Poppet	1/2"	●	Ball	Nitrile	-40° to +250° F	3000 PSI	
5000 Series	Ball	1/2"	●	Threads	Nitrile	-40° to +250° F	2500 PSI	
High Pressure								
FH Series	Flush Face	3/8"	●	Ball	Nitrile	-40° to +250° F	10,000 PSI	
3000 Series	Ball	1/4 to 3/8"	●	Threads	Polyurethane	-65° to +180° F	10,000 PSI	
TC Series	Poppet	3/8"	●	Ball	Fluorocarbon	-15° to +400° F	10,000 PSI	
1141 Series	Poppet	1/4"		●	Threads	Polyurethane	-40° to +180° F	10,000 PSI
Mold Coolant								
Moldmate	Valved & Unvalved	1/4 to 1/2"	●	Ball	Silicone	-20° to +400° F	200 PSI	
High Flow								
ST Series	Unvalved	1/8 to 1 1/2"	● ● ●	Ball	Nitrile	-40° to +250° F	2500 to 6700 PSI	
HO Series	Unvalved	1/4 to 1/2"	●	Ball	Nitrile	-40° to +250° F	10,000 to 15,000 PSI	
Water Service	Unvalved	3/4"	●	Ball	Nitrile	-40° to +250° F	200 PSI	
Special Purpose - Miniature								
DM Series	Poppet	1/8	●	Ball	Fluorocarbon	-15° to +400° F	250 PSI	

See Fluid Compatibility chart and/or consult factory for questions regarding proper material for specific applications.

* Material Code: Br = Brass; S = Steel; S3 = 303 Stainless Steel; S6 = 316 Stainless Steel

**Optional Seals	Seal Material	Specific Coupling Series Using Optional Seal Suffix Designator at left
W	Ethylene Propylene	60, 6600, 4000, 4200, 6100, 5000, 8200, 9200, ST
Y	Fluorocarbon	60, 6600, 4000, 4200, 6100, 5000, 8200, 9200, ST, Moldmate (if used with oil based media only)
Z	Neoprene	60, 6600, 4000, 4200, 6100, 5000, 8200, 9200, ST
E5	Ethylene Propylene	SM, HP, NS, FF, FE, FEM, FH, FS, HO
E4	Fluorocarbon	SM, HP, NS, FF, FE, FEM, FH, FS (STD-no suffix needed), HO, TC (Fluorocarbon only-no suffix needed)
E12	Neoprene	SM, HP, NS, FF, FE, FEM, FH, FS, HO
E47	Perfluoroelastomer	SM, HP, NS, FF, FE, FEM, FH, FS (Contact the division re: Perfluoroelastomer options) 3000 and 1141 with Polyurethane only (no suffix needed) Water Service (Nitrile only)

To select proper Seal Materials, see Fluid Compatibility chart in Appendices, or contact your Parker Quick Coupling Distributor.





Applications

Parker general purpose couplings, are used across the spectrum of hydraulic applications. These Double Shut-Off couplings can be found anywhere that fluid transfer lines need to be connected and disconnected for operation or maintenance of equipment, and a loss of fluid is undesirable. Primarily used with hydraulic fluid, general purpose Double Shut-Off couplings are also used with chemicals, water, steam, and some gases.

Special Order Information

60 Series couplings are available in zinc plated steel, brass, 303 stainless steel, and 316 stainless steel. Brass couplings have double O-Ring seals and stainless locking balls.

Standard seal material is Nitrile; optional seal materials are available.

For 316 stainless steel products, standard seal material is Fluorocarbon, and other seal materials are available upon request. See Fluid Compatibility Chart at end of this catalog.

All sizes of 60 Series can be furnished with locking sleeves. Place suffix letters “-SL” (Sleeve-Lok) after regular catalog numbers. Example H3-62-SL. Parker 60 Series heavy duty nipples are recommended where high cycle rates and pressure surges are encountered. Machined from high tensile steel and induction hardened, they are zinc plated with a yellow chromate finish. To specify a heavy duty nipple, add the prefix “HD” to the steel part number; thus: HD-H2-63.

Note

Protective dust plugs and caps play a crucial role in the life of a quick coupling and no purchase of a hydraulic quick coupling is complete without the selection of an appropriate dust plug and cap. See pages noted in Table of Contents for dust plugs and caps for the Parker full line of hydraulic couplings.

Specifications

Industry Standard: Parker 60 Series couplings comply with ISO 7241 Series B Standard.																
ANSI/ISO Pressure Rating: Dynamic applications with normal to moderate hydraulic shocks such as general industrial equipment, hydraulic presses, agricultural equipment, etc. Impulse tested at a multiple (125% to 133%) of rated pressure.									Low Cycle, Non-pulsating Pressure Rating: Applications with lower cycle life and no severe cyclic pressure fluctuations, essentially steady pressure during an operating cycle. Typical applications include hydraulic jacks, mine roof support systems, and high pressure fluid transfer (pumping water or slurry in oil wells). Minor pump ripple is considered non-pulsating. Impulse tested at rated pressure.							
Body Size (in.)	1/8	1/4	3/8	1/2	3/4	1	1 1/2	2 1/2	1/8	1/4	3/8	1/2	3/4	1	1 1/2	2 1/2
	Rated Pressure (PSI)								Rated Pressure (PSI)							
Brass	1000	1000	1000	1000	1000	1000	800	800	3000	3700	2700	3500	2200	1500	1500	1200
Stainless steel	2000	2000	1500	1500	1500	1000	1000	1000	5000	5000	5000	5000	3000	3000	1500	1500
Steel	5000	5000	4000	4000	2500	2000	1000	1000	5000	5000	4000	4000	2500	2000	1500	1500
Steel w / HD nipple	N/A	5000	4000	4000	3000	3000	N/A	N/A	5000	5000	4000	4000	3000	3000	N/A	N/A
Seal Temperature Range: Nitrile: -40°F to +250°F (Standard seal for Brass, Steel, & 303 Stainless Steel couplings. Fluorocarbon: -15°F to +400°F (Standard seal for 316 Stainless Steel couplings. Other Seal materials: Contact the Division for availability.																
Vacuum Data: 27.4 inches Hg. both connected and disconnected (1-1/2" and 2-1/2" body size 60 Series couplings are not recommended for service in disconnected mode)																
Note: Read the Safety Guide for Selecting and Using Quick Action Couplings and Related Accessories before making a coupling selection. It may be found in Parker Hannifin Quick Coupling Division catalogs and is available as Parker Publication No. 3800-B1.0.																

Body Size (in.)	1/8	1/4	3/8	1/2	3/4	1	1 1/2	2 1/2
Rated Flow (GPM)	.8	3	6	12	28	50	100	200

Hydraulic Quick Couplings

General Purpose Couplings

60 Series

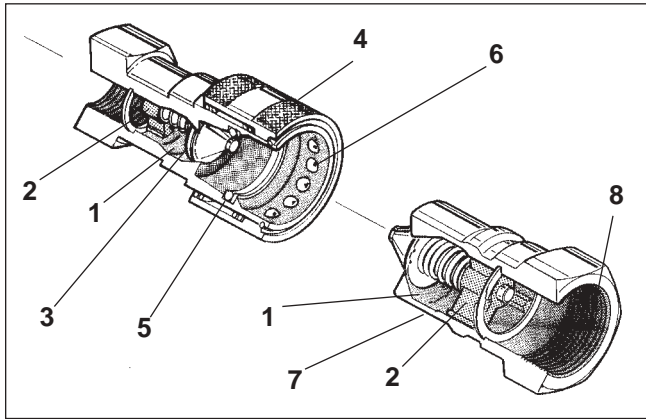

Features

1. Large flow areas machined into the body of the coupler and nipple facilitate flow around the valve, for a high flow capacity.
2. Positive valve stop. The perch maintains valve alignment and provides metal to metal valve stop to ensure that the valves open fully, every time.
3. Captive valve seal assures "bubble tight" poppet sealing. The valve seal is positively captured by the metal poppet to minimize seal washout or damage from high velocity fluid.
4. Hardened nipples and sleeves (steel) and solid barstock construction make for a quality coupling with maximum resistance to damage from hydraulic and mechanical shock.
5. The seal is designed to withstand high pressures and provide reliable sealing. A wide selection of optional seal materials are available, see Fluid Compatibility Chart at end of this catalog for selection assistance. Steel versions feature PTFE back-up rings that support mating seals for high pressure applications. Brass couplers have a double O-ring seal for redundancy in low pressure, vacuum and steam applications.
6. Durable ball-locking mechanism assures reliable connection, every time. A large number of locking balls distributes the work load evenly while providing alignment and swiveling action to reduce hose torque and prolong hose life.
7. Manufactured from brass, steel and stainless steel as standard materials. A wide range of seals allow these couplings to be used with a broad range of media.
8. Also available with a Straight Thread (ORB) end configuration available as standard.
9. Industrial Standard: Parker 60 Series couplings comply with ISO 7241, Series B Standard.

Performance

60 Series (1/8" & 1/4")
Test Fluid: Oil - 150 SUS

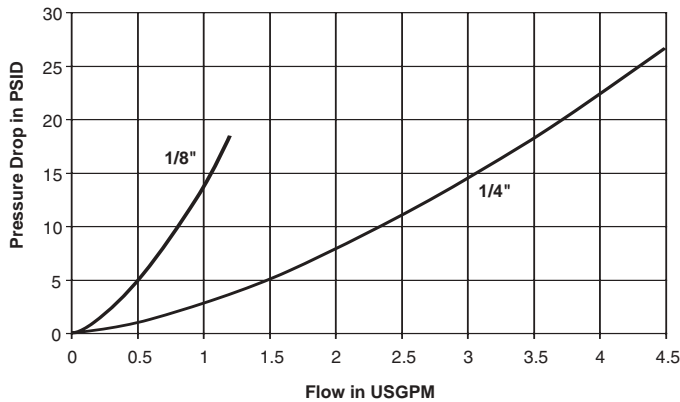

60 Series (3/8" & 1/2")
Test Fluid: Oil - 150 SUS

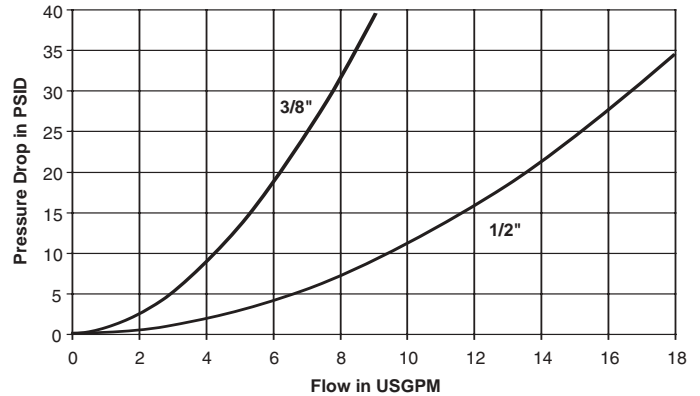

60 Series (3/4" & 1")
Test Fluid: Oil - 150 SUS

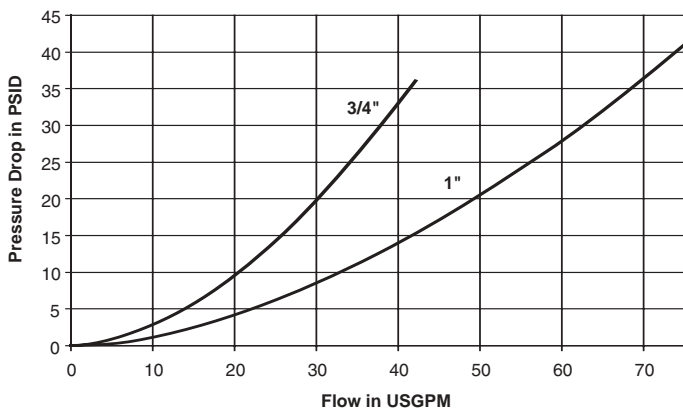

60 Series (1-1/2" & 2-1/2")
Test Fluid: Oil - 200 SUS

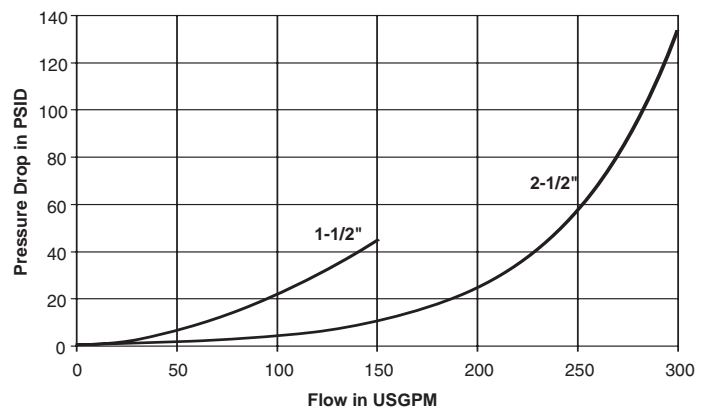

Hydraulic Quick Couplings

General Purpose Couplings 60 Series

Couplers

Female Thread

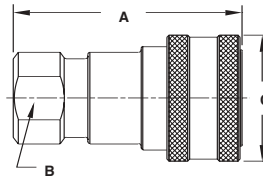

Body Size (in.)	Part No. Brass	Wt. (LB.) P/Piece	Part No. Steel	Wt. (LB.) P/Piece	Part No. Type 303 Stainless	Wt. (LB.) P/Piece	Part No. Type 316 Stainless	Wt. (LB.) P/Piece	Thread Size NPTF	Thread Size ORB	Dimensions (in.)			
											Overall Length	Wrench Flats	Largest Diameter	
												A	B	C
1/8	BH1-60	0.16	H1-62	0.16	SH1-62	0.16	SSH1-62Y	0.15	1/8-27	-	1.90	0.68	0.96	
1/8	-	-	H1-62-T4	0.18	SH1-62-T4	0.10	SSH1-62Y-T4	0.17	-	7/16-20	2.06	0.68	0.96	
1/4	BH2-60	0.32	H2-62	0.30	SH2-62	0.30	SSH2-62Y	0.30	1/4-18	-	2.26	0.81	1.14	
1/4	-	-	H2-62-T6	0.31	SH2-62-T6	0.31	SSH2-62Y-T6	0.31	-	9/16-18	2.41	0.81	1.14	
3/8	BH3-60	0.43	H3-62	0.40	SH3-62	0.40	SSH3-62Y	0.40	3/8-18	-	2.49	0.88	1.40	
3/8	-	-	H3-62-T8	0.51	SH3-62-T8	0.51	SSH3-62Y-T8	0.51	-	3/4-16	2.75	1.00	1.40	
1/2	BH4-60	0.80	H4-62	0.73	SH4-62	0.75	SSH4-62Y	0.76	1/2-14	-	2.87	1.12	1.77	
1/2	-	-	H4-62-T10	0.78	SH4-62-T10	0.75	SSH4-62Y-T10	0.78	-	7/8-14	3.05	1.12	1.77	
3/4	BH6-60	-	H6-62	1.30	SH6-62	1.31	SSH6-62Y	1.33	3/4-14	-	3.56	1.31	2.14	
3/4	-	-	H6-62-T12	1.39	SH6-62-T12	1.34	SSH6-62Y-T12	1.40	-	1-1/16-12	3.56	1.31	2.14	
1	BH8-60	-	H8-62	1.95	SH8-62	1.95	SSH8-62Y	1.95	1-11 1/2	-	4.18	1.62	2.52	
1	-	-	H8-62-T16	1.95	SH8-62-T16	1.95	SSH8-62Y-T16	1.95	-	1-5/16-12	4.18	1.62	2.52	

Nipples

Female Thread

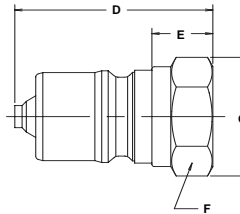

Body Size (in.)	Part No. Brass	Wt. (LB.) P/Piece	Part No. Steel	Wt. (LB.) P/Piece	Part No. Type 303 Stainless	Wt. (LB.) P/Piece	Part No. Type 316 Stainless	Wt. (LB.) P/Piece	Thread Size NPTF	Thread Size ORB	Dimensions (in.)				
											Overall Length	Exposed Length*	Wrench Flats	Largest Diameter	
												D	E	F	G
1/8	BH1-61	0.04	H1-63	0.03	SH1-63	0.03	SSH1-63Y	0.04	1/8-27	-	1.26	0.44	0.56	0.65	
1/8	-	0.06	H1-63-T4	0.05	SH1-63-T4	-	SSH1-63Y-T4	0.06	-	7/16-20	1.41	0.59	0.69	0.79	
1/4	BH2-61	0.09	H2-63	0.08	SH2-63	0.08	SSH2-63Y	0.08	1/4-18	-	1.54	0.55	0.75	0.87	
1/4	-	0.11	H2-63-T6	0.10	SH2-63-T6	0.10	SSH2-63Y-T6	0.10	-	9/16-18	1.69	0.70	0.88	1.01	
3/8	BH3-61	0.10	H3-63	0.12	SH3-63	0.12	SSH3-63Y	0.12	3/8-18	-	1.68	0.54	0.88	1.01	
3/8	-	0.12	H3-63-T8	0.16	SH3-63-T8	0.16	SSH3-63Y-T8	0.14	-	3/4-16	1.94	0.80	1.00	1.15	
1/2	BH4-61	0.25	H4-63	0.24	SH4-63	0.24	SSH4-63Y	0.24	1/2-14	-	1.94	0.69	1.12	1.30	
1/2	-	0.28	H4-63-T10	0.27	SH4-63-T10	0.27	SSH4-63Y-T10	0.27	-	7/8-14	2.12	0.87	1.19	1.37	
3/4	BH6-61	0.50	H6-63	0.46	SH6-63	0.45	SSH6-63Y	0.46	3/4-14	-	2.43	0.79	1.38	1.59	
3/4	-	0.55	H6-63-T12	0.46	SH6-63-T12	0.50	SSH6-63Y-T12	0.50	-	1-1/16-12	2.54	0.90	1.34	1.59	
1	BH8-61	0.76	H8-63	0.76	SH8-63	0.76	SSH8-63Y	0.76	1-11 1/2	-	2.91	0.99	1.62	1.88	
1	-	0.80	H8-63-T16	0.80	SH8-63-T16	0.80	SSH8-63Y-T16	0.80	-	1-5/16-12	2.91	0.99	1.62	1.88*	

* This dimension represents the portion that is exposed when the nipple is inserted into the mating Parker Coupler.

Optional Seals

60 Series



Optional Seals Suffix

W	Ethylene Propylene (EPR)
Y	Fluorocarbon
Z	Neoprene
	Perfluoroelastomer (Contact factory for Seal options)



Hydraulic Quick Couplings

General Purpose Couplings 60 Series

Couplers

Female Thread

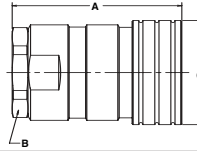

Body Size (in.)	Part No. Brass	Wt. (LB.) P/Piece	Part No. Steel	Wt. (LB.) P/Piece	Part No. Type 303 Stainless	Wt. (LB.) P/Piece	Part No. Type 316 Stainless	Wt. (LB.) P/Piece	Thread Size NPTF	Thread Size ORB	Dimensions (in.)		
											Overall Length	Wrench Flats	Largest Diameter
											A	B	C
1 1/2	BH12-60L	4.58	H12-62L	4.70	SH12-62L	4.68	SSH12-62LY	4.68	1 1/4-11 1/2	-	4.86	2.38 [‡]	3.00
1 1/2	BH12-60N	4.58	H12-62N	4.70	SH12-62N	4.68	SSH12-62NY	4.68	1 1/2-11 1/2	-	4.86	2.38 [‡]	3.00
1 1/2	-	4.61	H12-62-T20	4.72	SH12-62-T20	4.71	SSH12-62Y-T20	4.71	-	1 5/8-12	4.86	2.38 [‡]	3.00
1 1/2	-	4.61	H12-62-T24	4.72	SH12-62-T24	4.71	SSH12-62Y-T24	4.71	-	1 7/8-12	4.86	2.38 [‡]	3.00
2 1/2	BH2016-60	11.06	H2016-62	10.58	SH2016-62	-	SSH2016-62Y	-	2-11 1/2	-	5.57	3.75	4.10
2 1/2	BH2020-60	11.42	H2020-62	10.91	SH2020-62	-	SSH2020-62Y	-	2 1/2-8	-	6.04	3.75	4.10
2 1/2	BH2024-60	-	H2024-62	-	SH2024-62	-	SSH2024-62Y	-	3-8	-	6.96	4.00	4.35

‡Wrench Flat on 303 Stainless is 2.50 in.

Nipples

Female Thread

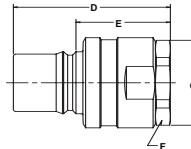

Body Size (in.)	Part No. Brass	Wt. (LB.) P/Piece	Part No. Steel	Wt. (LB.) P/Piece	Part No. Type 303 Stainless	Wt. (LB.) P/Piece	Part No. Type 316 Stainless	Wt. (LB.) P/Piece	Thread Size NPTF	Thread Size ORB	Dimensions (in.)			
											Overall Length	Exposed Length*	Wrench Flats	Largest Diameter
											D	E	F	G
1 1/2	BH12-61L	2.96	H12-63L	3.10	SH12-63L	3.06	SSH12-63LY	-	1 1/4-11 1/2	-	4.76	2.69	2.38 [‡]	2.75 [†]
1 1/2	BH12-61N	2.96	H12-63N	3.10	SH12-63N	3.06	SSH12-63NY	-	1 1/2-11 1/2	-	4.76	2.69	2.38 [‡]	2.75 [†]
1 1/2	-	-	H12-63-T20	3.15	SH12-63-T20	3.14	SSH12-63Y-T20	-	-	1 5/8-12	4.76	2.69	2.38 [‡]	2.75 [†]
1 1/2	-	-	H12-63-T24	3.15	SH12-63-T24	3.14	SSH12-63Y-T24	-	-	1 7/8-12	4.76	2.69	2.38 [‡]	2.75 [†]
2 1/2	BH2016-61	7.78	H2016-63	7.90	SH2016-63	7.92	SSH2016-63Y	-	2-11 1/2	-	5.48	2.90	3.75	4.10
2 1/2	BH2020-61	8.12	H2020-63	8.16	SH2020-63	8.16	SSH2020-63Y	-	2 1/2-8	-	5.95	3.37	3.75	4.10
2 1/2	BH2024-61	-	H2024-63	-	SH2024-63	-	SSH2024-63Y	-	3-8	-	6.87	4.29	4.00	4.35

* This dimension represents the portion that is exposed when the nipple is inserted into the mating Parker Coupler.

† Largest diameter on Brass is 2.96" across Hex Corners

‡ Hex on 303 Stainless is 2.50 in.

Replacement Parts

60 Series Couplers

Body Size (in.)	O-Rings - Nitrile	Back-Up Rings
1/8	50001-013-0010	H67A-28
1/4	50001-015-0010	H67C-28
3/8	50001-116-0010	4118007
1/2	50001-213-0010	4128002
3/4	50001-218-0010	4148001
1	50001-222-0010	4158001
1-1/2	50001-124-0010 (Valve)	50001-138-0260 (Fitting) 50001-224-0010 (Body 2 req.)
2-1/2	50001-133-0010 (Valve)	50001-234-0260 (Fitting) 50001-333-0010 (Body)

Repair Kits

Couplers

Nipples

Body Size (in.)	Repair Kit Part No.	Used For Part No.	Repair Kit Part No.	Used For Part No.
3/8	H67E-62K	H3-62	H67E-63K	H3-63
	BH67E-60K	BH3-60	BH67E-61K	BH3-61
	SH67E-62K	SH3-62	SH67E-63K	SH3-63
	SSH67E-62KY	SSH3-62Y	SSH67E-63KY	SSH3-63Y
1/2	H67F-62K	H4-62	H67F-63K	H4-63
	BH67F-60K	BH4-60	BH67F-61K	BH4-61
	SH67F-62K	SH4-62	SH67F-63K	SH4-63
	SSH67F-62KY	SSH4-62Y	SSH67F-63KY	SSH4-63Y
3/4	H67G-62K	H6-62	H67G-63K	H6-63
	BH67G-60K	BH6-60	BH67G-61K	BH6-61
	SH67G-62K	SH6-62	SH67G-63K	SH6-63
	SSH67G-62KY	SSH6-62Y	SSH67G-63KY	SSH6-63Y
1	H67J-62K	H8-62	H67J-63K	H8-63
	BH67J-60K	BH8-60	BH67J-61K	BH8-61
	SH67J-62K	SH8-62	SH67J-63K	SH8-63
	SSH67J-62KY	SSH8-62Y	SSH67J-63KY	SSH8-63Y



Hydraulic Quick Couplings

General Purpose Couplings 60 Series Steam Couplings



Specifications

Body Size (in.)	1/4 to 1
Standard Seal Material	Ethylene Propylene
Temperature Range	up to +400°

Coupler

Female Pipe Thread

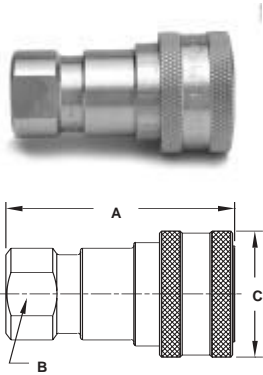

Body Size (in.)	Part No. Brass	Thread Size NPTF	Dimension (in.)			Wt. (LB.) P/Piece
			Overall Length	Wrench Flats	Largest Diameter	
			A	B	C	
1/4	BH2-60-STM	1/4-18	2.26	0.81	1.14	0.30
3/8*	H3-68	3/8-18	2.50	0.88	1.77	0.50
1/2	BH4-60-STM	1/2-14	2.87	1.12	1.77	0.75
3/4	BH6-60-STM	3/4-14	3.56	1.31	2.14	1.31
1	BH8-60-STM	1-11 1/2	4.18	1.62	2.52	1.95

* See Photo and Drawing below for 3/8 inch size coupler configuration.

Coupler - 3/8 Inch Configuration

Female Pipe Thread

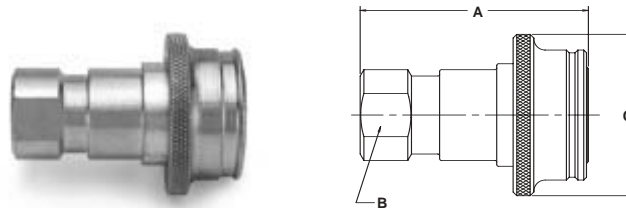

Nipple

Female Pipe Thread

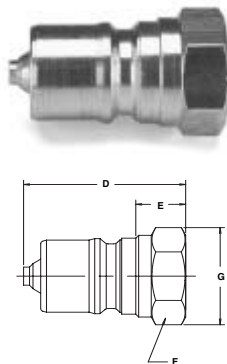

Body Size (in.)	Part No. Brass	Thread Size NPTF	Dimension (in.)				Largest Diameter	Wt. (LB.) P/Piece
			Overall Length	Exposed* Length	Hex Size	Hex Size		
			D	E	F	G		
1/4	BH2-61-STM	1/4-18	1.54	0.65	0.75	0.87	0.08	
3/8	H3-69	3/8-18	1.68	0.52	0.88	1.01	0.13	
1/2	BH4-61-STM	1/2-14	1.94	0.69	1.12	1.30	0.24	
3/4	BH6-61-STM	3/4-14	2.43	0.79	1.38	1.59	0.46	
1	BH8-61-STM	1-11 1/2	2.91	0.99	1.62	1.88	0.76	

* This dimension represents the portion that is exposed when the nipple is inserted into the mating Parker Coupler.

Repair Kits

Steam Coupling

Body Size	Repair Kit Part No.	Used For Part No.
3/8	H68E-67K	H3-68
3/8	H69E-67K	H3-69





Features

- Poppet valves are mated with a solid metal perch that maintains valve alignment and prevents flow checking.
- Both the coupler's sleeve and the nipple's body are hardened to make the 6600 Series couplings resistant to damage from brinelling and mechanical shock.
- The durable-ball-locking mechanism ensures a reliable connection every time.
- 6600 Series couplings have female pipe and straight thread end configurations as standard.
- Parker 6600 Series couplings interchange with couplings meeting ISO 7241-1, Series A.

Applications

Versatile Parker 6600 Series couplings are used in a wide range of hydraulic applications including construction equipment, manufacturing machinery, and in-plant systems. They can be found anywhere the fluid transfer lines need to be connected and disconnected for operation or maintenance of equipment. Rugged construction makes the 6600 Series a good choice for mobile applications including dump trucks, snow plows, refuse hauling, mining, asphalt paving, truck trailer connections and many more. In-plant machinery applications include hydraulic fluid, chemicals and gas lines for paper mills, steel production, and many varieties of plant maintenance and production equipment.

Note: Protective dust plugs and caps play a crucial role in the life of a quick coupling and no purchase of a hydraulic quick coupling is complete without the selection of an appropriate dust plug and cap. See pages noted in Table of Contents for dust plugs and caps for the Parker full line of hydraulic couplings.

Specifications

Body Size (in.)	1/4	3/8	1/2	3/4	1
Rated Pressure (PSI)	5000	4000	4000	4000	4000
Rated Flow (GPM)	0.8	6	12	28	50
Temperature Range (Nitrile seals)	-40° to +250°F				

Performance

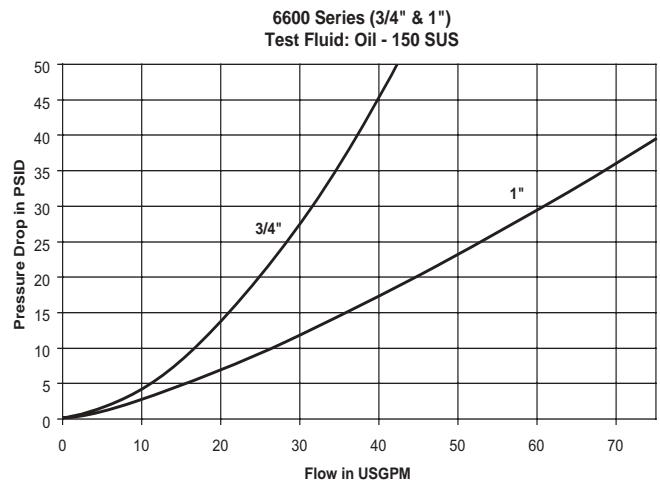
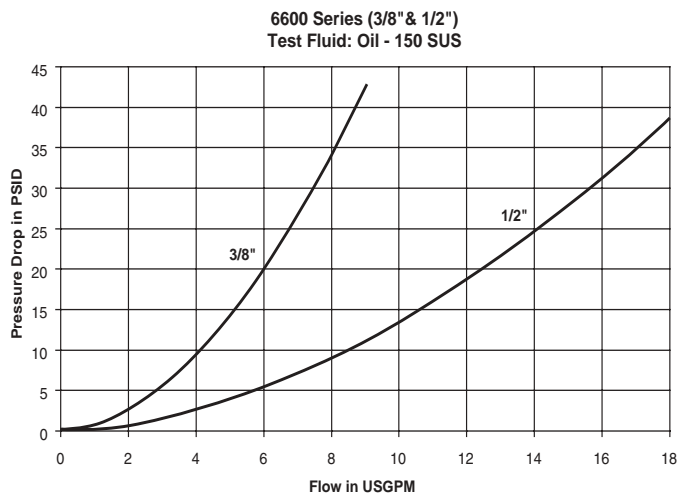
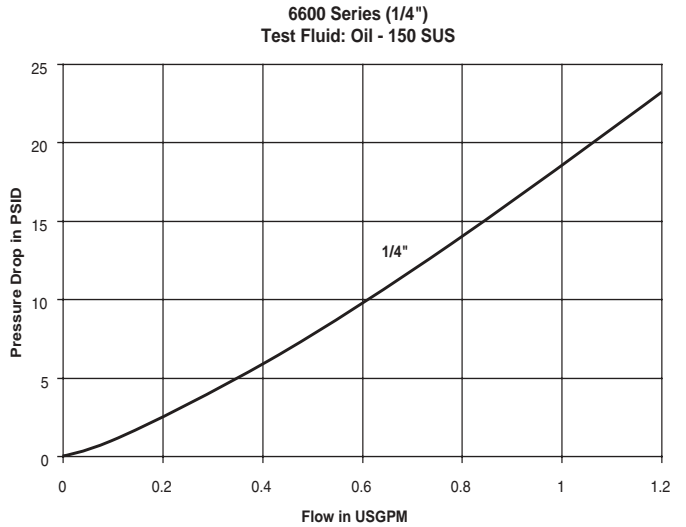

Hydraulic Quick Couplings

General Purpose Couplings 6600 Series

Couplers

Female Thread

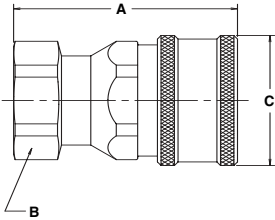

Body Size (in.)	Part No. Steel	Thread Size NPTF	Thread Size ORB	Dimensions (in.)			Wt. (LB.) P/Piece
				Overall Length	Hex Size	Largest Diameter	
				A	B	C	
1/4	6601-2-4	1/8-27	—	1.85	.88	1.08	0.27
1/4	6601-4-4	1/4-18	—	1.85	.88	1.08	0.26
3/8	6601-6-6	3/8-18	—	2.18	1.06	1.27	0.39
3/8	6608-6-6	—	9/16-18	2.18	1.06	1.27	0.38
1/2	6601-8-10	1/2-14	—	2.75	1.25	1.52	0.67
1/2	6601-12-10	3/4-14	—	2.88	1.38	1.52	0.71
1/2	6608-8-10	—	3/4-16	2.74	1.25	1.52	0.67
1/2	6608-10-10	—	7/8-14	2.79	1.25	1.52	0.64
1/2	6608-12-10	—	1 1/16-12	3.01	1.38	1.52	0.77
3/4	6601-12-12	3/4-14	—	3.36	1.62	1.90	1.31
3/4	6608-12-12	—	1 1/16-12	3.35	1.62	1.90	1.31
1	6601-16-16	1-11 1/2	—	4.11	1.88	2.14	0.73
1	6608-16-16	—	1 5/16-12	4.11	1.88	2.14	1.73

Nipples

Female Thread

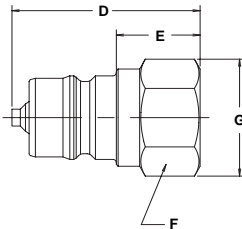

Body Size (in.)	Part No. Steel	Thread Size NPTF	Thread Size ORB	Overall Length	Dimensions (in.)			Wt. (LB.) P/Piece
					Exposed* Length	Hex Size	Largest Diameter	
					D	E	F	G
1/4	6602-2-4	1/8-27	—	1.41	.50	.56	.65	0.05
1/4	6602-4-4	1/4-18	—	1.41	.58	.75	.87	0.07
3/8	6602-6-6	3/8-18	—	1.63	.72	.88	1.01	0.11
3/8	6610-6-6	—	9/16-18	1.63	.72	.88	1.01	0.13
1/2	6602-8-10	1/2-14	—	2.08	.78	1.06	1.23	0.21
1/2	6602-12-10	3/4-14	—	2.30	.78	1.38	1.59	0.33
1/2	6610-8-10	—	3/4-16	2.08	.76	1.06	1.23	0.22
1/2	6610-10-10	—	7/8-14	2.08	.82	1.12	1.30	0.21
1/2	6610-12-10	—	1 1/16-12	2.30	1.04	1.38	1.59	0.33
3/4	6602-12-12	3/4-14	—	2.55	1.18	1.38	1.59	0.49
3/4	6610-12-12	—	1 1/16-12	2.55	1.18	1.38	1.59	0.47
1	6602-16-16	1-11 1/2	—	3.10	1.34	1.62	1.88	0.75
1	6610-16-16	—	1 5/16-12	3.10	1.34	1.62	2.17	0.72

* This dimension represents the portion that is exposed when the nipple is inserted into the mating parker Coupler.

Replacement Parts

6600 Series

Body Size (in.)	1/4	3/8	1/2	3/4	1
O-Rings - Nitrile	50001-112-0010	50001-115-0010	50001-211-0010	50001-123-0010	50001-126-0010
Back-up Rings	4118006	4118005	50-140-4	4138001	4148002



Features

The SM Series couplings feature:

- Poppet valves with captive valve seals: the valve seal is positively captured by the metal poppet to minimize seal washout.
- Coupler and nipple are precision machined from solid barstock.
- SM Series are available in female pipe (NPTF), SAE O-Ring Boss and British Pipe (BSPP) as standard.

Applications

SM Series couplings are used across the spectrum of hydraulic applications. These Double Shut-Off couplings can be found anywhere that fluid transfer lines need to be connected and disconnected for operation or maintenance of equipment, and a loss of fluid is undesirable. Designed for use with commercial grades of hydraulic fluids. These couplings are ideally suited for all mobile or industrial applications.

Specifications

Body Size (in.)	1/4	1/2	3/4
Rated Pressure (PSI)	6,000	6,000	4,500
Rated Flow (GPM)	3	12	28
Temperature Range (Nitrile Seals)	-40° to +250°F		

Note: Protective dust plugs and caps play a crucial role in the life of a quick coupling and no purchase of a hydraulic quick coupling is complete without the selection of an appropriate dust plug and cap. See pages noted in Table of Contents for dust plugs and caps for the Parker full line of hydraulic couplings.

Performance

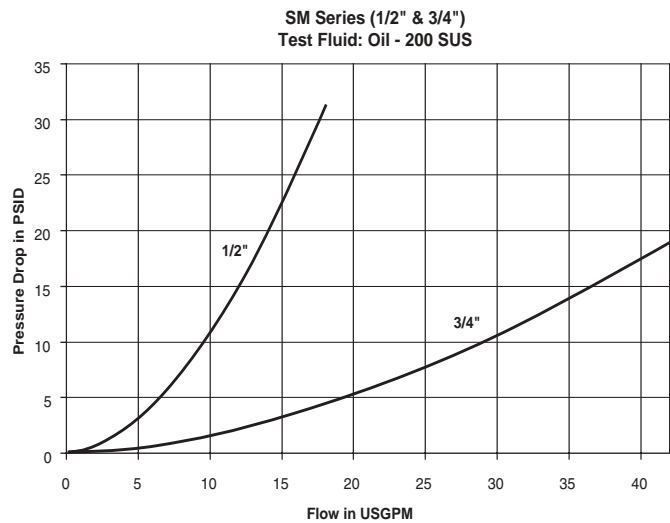
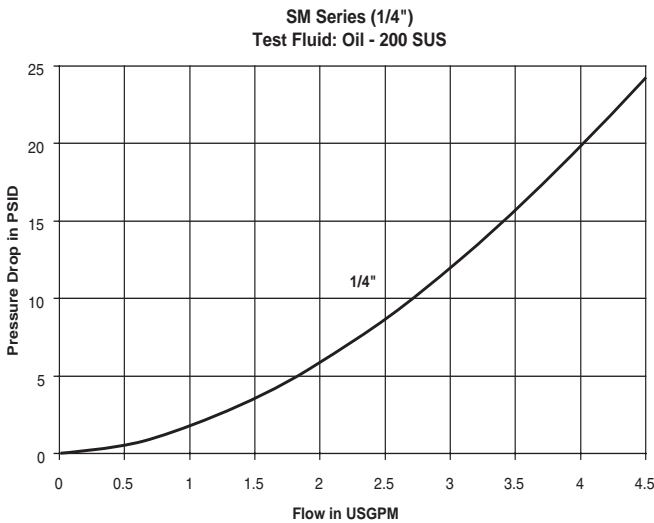

Hydraulic Quick Couplings

General Purpose Couplings

SM Series

Couplers

Female Thread

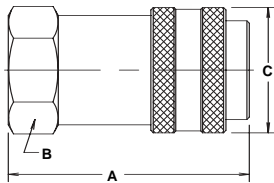

Body Size (in.)	Part No. Steel	Thread Size	Dimensions (in.)			Wt. (LB.) P/Piece
			Overall Length	Hex Size	Largest Diameter	
			A	B	C	
1/4	SM-251-4FP	1/4-18 NPTF	1.89	0.75	1.06	0.24
1/4	SM-251-4FB	G1/4 BSPP	2.04	0.75	1.06	0.26
1/4	SM-251-6FP	3/8-18 NPTF	2.04	0.94	1.06	0.28
1/4	SM-251-6FB	G3/8 BSPP	2.04	0.94	1.06	0.26
1/4	SM-251-6FO	9/16-18ORB	2.04	0.75	1.06	0.25
1/2	SM-501-8FP	1/2-14 NPTF	2.81	1.25	1.56	0.70
1/2	SM-501-8FB	G1/2 BSPP	2.95	1.25	1.56	0.74
1/2	SM-501-12FP	3/4-14 NPTF	2.99	1.37	1.56	0.81
1/2	SM-501-12FB	G3/4 BSPP	3.16	1.37	1.56	0.85
1/2	SM-501-8FO	3/4-16ORB	2.95	1.25	1.56	0.70
3/4	SM-751-12FO	1 1/16-12ORB	3.62	1.62	2.25	1.78
3/4	SM-751-12FP	3/4-14 NPTF	3.62	1.62	2.22	1.83
3/4	SM-751-12FB	G3/4 BSPP	3.76	1.62	2.22	1.88
3/4	SM-751-16FP	1-11 1/2 NPTF	3.90	1.62	2.22	1.84
3/4	SM-751-16FB	G 1 BSPP	3.90	1.62	2.22	1.89
3/4	SM-751-16FO	1-5/16-12ORB	3.90	1.62	2.22	1.89

Nipples

Female Thread

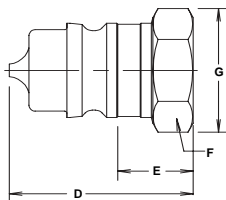

Body Size (in.)	Part No. Steel	Thread Size	Dimensions (in.)				Wt. (LB.) P/Piece
			Overall Length	Exposed* Length	Hex Size	Largest Diameter	
			D	E	F	G	
1/4	SM-252-4FP	1/4-18 NPTF	1.29	0.50	0.75	0.87	0.08
1/4	SM-252-4FB	G1/4 BSPP	1.44	0.65	0.75	0.87	0.09
1/4	SM-252-6FP	3/8-18 NPTF	1.60	0.81	0.94	1.08	0.14
1/4	SM-252-6FB	G3/8 BSPP	1.60	0.81	0.94	1.08	0.14
1/4	SM-252-6FO	9/16-18ORB	1.44	0.55	0.75	0.87	0.08
1/2	SM-502-8FO	3/4-16ORB	2.27	0.72	1.06	1.23	0.16
1/2	SM-502-8FP	1/2-14 NPTF	1.81	0.45	1.06	1.23	0.15
1/2	SM-502-8FB	G1/2 BSPP	1.96	0.60	1.06	1.23	0.18
1/2	SM-502-12FP	3/4-14 NPTF	2.27	0.90	1.37	1.59	0.30
1/2	SM-502-12FB	G3/4 BSPP	2.44	1.07	1.37	1.59	0.34
3/4	SM-752-12FO	1 1/16-12ORB	2.33	0.39	1.50	1.73	0.48
3/4	SM-752-12FP	3/4-14 NPTF	2.33	0.39	1.50	1.73	0.52
3/4	SM-752-12FB	G3/4 BSPP	2.79	0.53	1.50	1.73	0.56
3/4	SM-752-16FP	1-11 1/2 NPTF	2.61	0.67	1.62	1.88	0.56
3/4	SM-752-16FB	G 1 BSPP	2.61	0.67	1.62	1.88	0.68
3/4	SM-752-16FO	1-5/16-12ORB	2.61	0.67	1.62	1.88	0.68

* This dimension represents the portion that is exposed when the nipple is inserted into the mating parker Coupler.

Optional Seals



Optional Seals Suffix (Standard seals are Nitrile)	
E4	Fluorocarbon
E5	Ethylene Propylene (EPR)
E12	Neoprene
	Perfluoroelastomer (Contact Factory for Seal Options)



Features

- Operating pressures up to 5,000 PSI (350 Bar).
- Soft seat valving prevents leakage when coupler and nipple are disconnected.
- Made of Carbon Steel. Exterior zinc plated with yellow chromate finish for corrosion resistance.
- Smooth Flow Path Minimizes Pressure Drop.
- Nitrile Body Seal supported by PTFE washer. Backup washer keeps seal from extruding at high pressures.
- Heat Treated Nipple and Heavy Duty Locking Collar withstands high pressure surges, hose twist and repeated pressure pulses.
- Nitrile Seals for General Purpose Hydraulic Applications.

Specifications

Body Size (in.)	1	1-1/2
Rated Pressure (PSI)	5,000	5,000
Rated Flow (GPM)	50	100
Temperature Range (std seals)	-40° to +250°F	

Performance

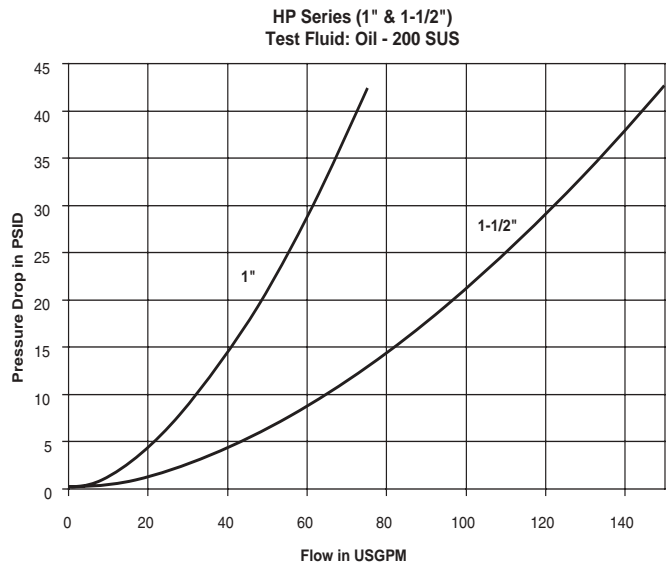

Hydraulic Quick Couplings

General Purpose Couplings HP Series (High Pressure Coupling)

Couplers

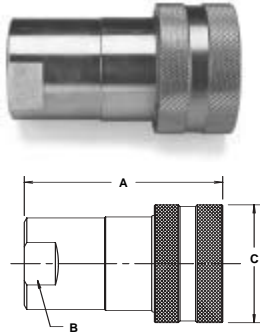

Body Size (in.)	Part No.	Thread Size	Overall Length	Wrench Flats	Largest Diameter	Wt. (LB.) P/Piec
			A	B	C	
1	HP-1001-16FP	1 -11 1/2 NPSF	3.95	1.62	2.38	2.10
1	HP-1001-16FO	1 5/16 -12 ORB	4.35	1.62	2.38	2.10
1 1/2	HP-1501-24FP	1 1/2-11 1/2 NPTF	4.93	2.25	3.00	4.40
1 1/2	HP-1501-24FO	1 7/8 -12 ORB	4.93	2.25	3.00	4.40

Nipples

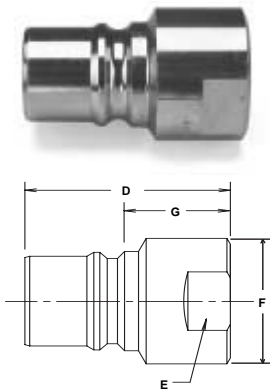

Body Size (in.)	Part No.	Thread Size	Overall Length	Wrench Flats	Largest Diameter	Exposed Length*	Wt. (LB.) P/Piece
			D	E	F	G	
1	HP-1002-16FP	1 11-1/2 NPSF	3.00	1.62	1.88	1.32	0.84
1	HP-1002-16FO	1 15/16-12ORB	3.40	1.62	1.88	1.72	0.84
1 1/2	HP-1502-24FP	1 1/2-11 1/2 NPTF	4.06	2.25	2.63	.99	1.85
1 1/2	HP-1502-24FO	1 7/8-12 ORB	4.06	2.25	2.63	.99	1.85

* This dimension represents the portion that is exposed when the nipple is inserted into the mating Parker Coupler.

Dust Plugs and Caps

Protective Plugs for Coupler			Protective Caps for Nipple		
P/N	Material	Fits Coupler	P/N	Material	Fits Nipple
HPP-100	Aluminum	HP-1001	HPC-100	Aluminum	HP-1002
HPP-150	Aluminum	HP-1501	HPC-150	Aluminum	HP-1502



Applications

The 4000 Series brings to the industry a proven design for use on construction equipment, forestry equipment, agricultural machinery, oil tools, steel mill machinery, and other demanding hydraulic applications.

Note: Protective dust plugs and caps play a crucial role in the life of a quick coupling and no purchase of a hydraulic quick coupling is complete without the selection of an appropriate dust plug and cap. See pages noted in Table of Contents for dust plugs and caps for the Parker full line of hydraulic couplings.

Special Order Information

Standard seal material is Nitrile, other seal options are available. See Ordering Information at end of Section B and Fluid Compatibility Chart at end of this catalog for assistance in making seal selection.

Note: The part numbers for the 4000 Series Poppet Valve design are designated with a -P. For example 4050-4P.

Specifications

Body Size (in.)	1/4	3/8	1/2	3/4	1
Rated Pressure (PSI)	3000	3000	3000	3000	3000
Rated Flow (GPM)	3	6	12	28	50
Temperature Range (std seals)	-40° to +250°F				

Features

Parker 4000 Series couplings feature:

- Poppet valves available to prevent uncoupled leakage.
- Ball valves available for rugged dependability in heavy-duty hydraulic applications, within rated working pressures.
- Critical parts are induction hardened for durability.
- Dependable ball-locking mechanism holds the mating halves together.
- Couplers and nipple are precision machined from solid bar stock.
- For applications with residual trapped pressure use connect-under-pressure nipples designated by the -DC option.

Performance

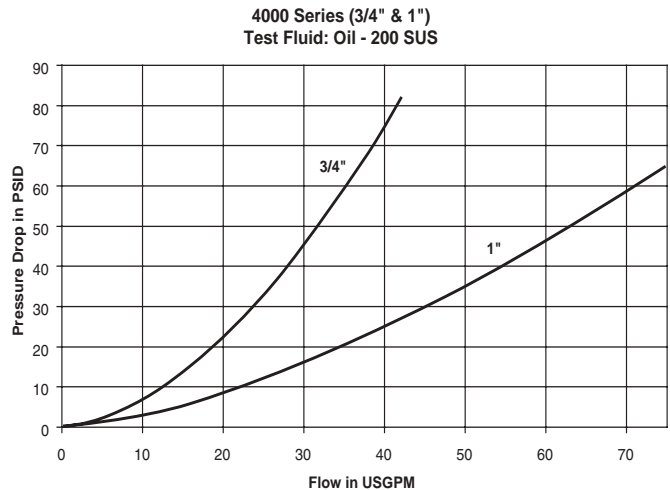
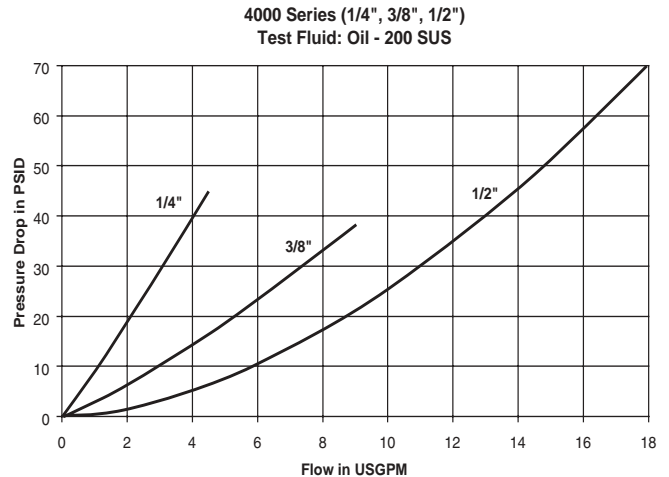

Hydraulic Quick Couplings

General Purpose Couplings 4000 Series

Couplers

Female Thread

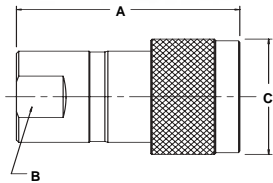
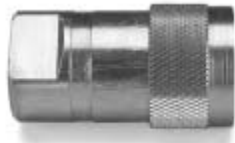

Body Size (in.)	Part No. Steel*	Thread Size NPTF	Thread Size ORB	Thread Size BSPP	Dimensions (in.)			Wt. (LB.) P/Piece	
					Overall Length	Wrench Flats	Largest Diameter		
					A	B	C		
1/4	4050-2P	1/4-18	-		2.18	0.88	1.06	0.24	
1/4	4050-2P-T8M	-	3/4-16 (Male)		1.80	0.88	1.06	0.21	
1/4	4050-T6	-	9/16-18		2.18	0.88	1.06	0.27	
1/4	4050P-T6**	-	9/16-18		2.43	0.81	1.33	0.33	
3/8	4050-3P	3/8-18	-		2.31	0.94	1.33	0.51	
1/2	4050-4	1/2-14	-		2.60	1.06	1.52	0.58	
1/2	4050-4P	1/2-14	-		2.60	1.06	1.52	0.58	
1/2	4050-5	3/4-14	-		2.69	1.13	1.52	0.71	
1/2	4050-5P	3/4-14	-		2.69	1.13	1.52	0.71	
1/2	4050-15	-	3/4-16		2.81	1.06	1.52	0.64	
1/2	4050-15P	-	3/4-16		2.81	1.06	1.52	0.64	
1/2	4050-16	-	7/8-14		2.75	1.06	1.52	0.59	
1/2	4050-16P	-	7/8-14		2.75	1.06	1.52	0.59	
1/2	4050-29BSPP	-	-	1/2-14	2.68	1.06	1.52	0.59	
3/4	4150-5	3/4-14	-		3.50	1.38	1.90	1.00	
1	4050-6P	1-11 1/2	-		3.84	1.63	2.08	1.89	

* P in part number designates Poppet design

** Push-to-Connect design.

Nipples

Female Thread

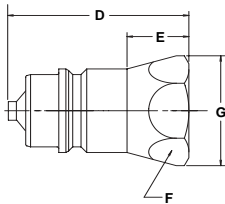

Body Size (in.)	Part No. Steel*	Thread Size NPTF	Thread Size ORB	Thread Size BSPP	Dimensions (in.)				Wt. (LB.) P/Piece	
					Overall Length	Exposed Length†	Hex Size	Largest Diameter		
					D	E	F	G		
1/4	4010-2P	1/4-18	-		1.39	0.71	0.75	0.87	0.08	
1/4	4010-T6	-	9/16-18		1.49	0.81	0.75	0.87	0.09	
3/8	4010-3P	3/8-18	-		1.50	.80	.94	1.08	0.16	
1/2	8010-4	1/2-14	-		1.95	1.09	1.06	1.23	0.20	
1/2	8010-4P	1/2-14	-		1.95	1.09	1.06	1.23	0.20	
1/2	8010-5	3/4-14	-		2.14	1.28	1.25	1.44	0.25	
1/2	8010-5P	3/4-14	-		2.14	1.28	1.25	1.44	0.25	
1/2	8010-15	-	3/4-16		2.06	1.20	1.06	1.23	0.20	
1/2	8010-15P	-	3/4-16		2.06	1.20	1.06	1.23	0.20	
1/2	8010-16	-	7/8-14		2.05	1.18	1.06	1.23	0.25	
1/2	8010-16P	-	7/8-14		2.05	1.18	1.06	1.23	0.25	
1/2	8010-29BSPP	-	-	1/2-14	1.95	1.09	1.06	1.18	0.25	
3/4	4110-5	3/4-14	-		1.81	1.23	1.31	1.52	0.50	
1	4010-6P	1-11 1/2	-		2.79	1.49	1.63	1.88	0.62	

* P in part number designates Poppet design

† This dimension represents the portion that is exposed when the nipple is inserted into the mating Parker Coupler.

Connect-Under-Pressure

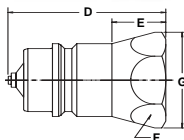

Body Size (in.)	Part No. Steel*	Thread Size NPTF	Thread Size ORB	Thread Size BSPP	Dimensions (in.)				Wt. (LB.) P/Piece	
					Overall Length	Exposed Length†	Hex Size	Largest Diameter		
					D	E	F	G		
1/2	8010-4P-DC	1/2-14	-	-	1.81	1.09	1.06	1.16	0.20	
1/2	8010-15P-DC	-	3/4-16	-	1.81	1.09	1.06	1.16	0.20	

Replacement Parts - 4000 Series

Body Size (in.)	1/4	3/8	1/2	3/4	1
O-Rings - Nitrile	50001-113-0260	50001-116-0260	50001-211-0260	50001-215-0010	50001-218-0260





Applications

The 4200 Series brings to the industry a proven design for use on construction equipment, forestry equipment agricultural machinery, and oil tools.

Note: Protective dust plugs and caps play a crucial role in the life of a quick coupling and no purchase of a hydraulic quick coupling is complete without the selection of an appropriate dust plug and cap. See pages noted in Table of Contents for dust plugs and caps for the Parker full line of hydraulic couplings.

Special Order Information

Standard seal material is Nitrile. For other seal options see Table of Contents. See Ordering Information at end of Section B and Fluid Compatibility Chart at end of this catalog for assistance in making seal selection.

Note: The part numbers for the 4200 Series Poppet Valve design are designated with a -P. For example 4250-4P.

Features

Parker 4200 Series couplings feature:

- Double acting sleeve for one handed push-to-connect operation when coupler is clamp or bulkhead mounted.
- Poppet valves available to prevent uncoupled leakage.
- Ball valves available for rugged dependability in heavy-duty hydraulic applications, within rated working pressures.
- Critical parts are induction hardened for durability.
- Dependable ball-locking mechanism holds the mating halves together.
- Couplers and nipple are precision machined from solid bar stock.
- For applications with residual trapped pressure use connect-under-pressure nipples designated by the -DC option.

Specifications

Body Size (in.)	3/8	1/2
Rated Pressure (PSI)	3000	3000
Rated Flow (GPM)	6	12
Temperature Range (std seals)	-40° to +250°F	

Performance

4200 Series (3/8" & 1/2")
Test Fluid: Oil - 200 SUS

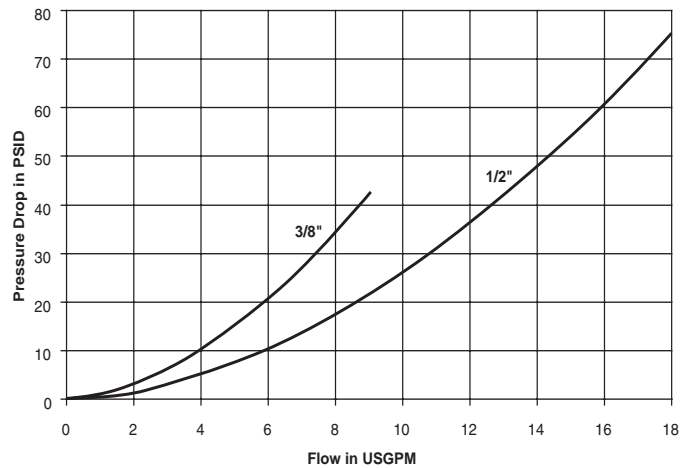

Hydraulic Quick Couplings

General Purpose Couplings 4200 Series

Couplers

Female Thread

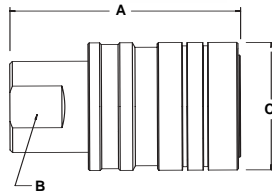

Body Size (in.)	Part No. Steel*	Thread Size NPTF	Thread Size ORB	Dimensions (in.)			Wt. (LB.) P/Piece
				Overall Length	Wrench Flats	Largest Diameter	
				A	B	C	
3/8	4250-3P	3/8-18	–	2.31	0.81	1.31	0.39
1/2	4250-4	1/2-14	–	2.68	0.94	1.50	0.55
1/2	4250-4P	1/2-14	–	2.68	0.94	1.50	0.55
1/2	4250-15	–	3/4-16	2.68	0.94	1.50	0.55
1/2	4250-15P	–	3/4-16	2.68	0.94	1.50	0.55

* P in part number designates Poppet design

Nipples

Female Thread

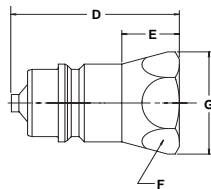

Body Size (in.)	Part No. Steel*	Thread Size NPTF	Thread Size ORB	Overall Length	Dimensions (in.)			Wt. (LB.) P/Piece
					Exposed Length**	Hex Size	Largest Diameter	
					D	E	F	G
3/8	4010-3P	3/8-18	–	1.60	0.80	0.94	1.08	0.16
1/2	8010-4	1/2-14	–	1.95	1.09	1.06	1.23	0.20
1/2	8010-4P	1/2-14	–	1.95	1.09	1.06	1.23	0.20
1/2	8010-15	–	3/4-16	2.06	1.20	1.06	1.23	0.20
1/2	8010-15P	–	3/4-16	2.06	1.20	1.06	1.23	0.20

* P in part number designates Poppet design

** This dimension represents the portion that is exposed when the nipple is inserted into the mating Parker Coupler.

Connect-Under-Pressure

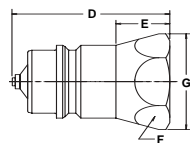

Body Size (in.)	Part No. Steel*	Thread Size NPTF	Thread Size ORB	Thread Size BSPP	Overall Length	Dimensions (in.)			Wt. (LB.) P/Piece
						Exposed Length**	Hex Size	Largest Diameter	
						D	E	F	G
1/2	8010-4P-DC	1/2-14	–	–	1.81	1.09	1.06	1.16	0.20
1/2	8010-15P-DC	–	3/4-16	–	1.81	1.09	1.06	1.16	0.20

** This dimension represents the portion that is exposed when the nipple is inserted into the mating Parker Coupler.

Replacement Parts - 4200 Series

Body Size (in.)	Part Number	Description	Material
1/2	50001-211-0260	O-Rings	Nitrile
3/8	50001-116-0260	O-Rings	Nitrile



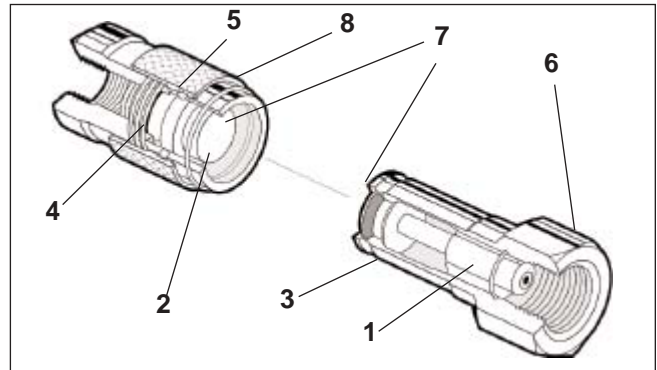

Applications

Non-Spill couplings by Parker are widely used in the public utility market where hydraulic oil spillage can constitute a serious safety hazard, particularly in overhead bucket hoists that are used for maintenance of high-voltage power transmission lines. These couplings are also used for quick change of hydraulic hand tools in the construction, railway maintenance and mining industries. They are also ideal for in-plant use where excess oil spillage can create a hazard.

Note: See pages noted in Table of Contents for dust plugs and caps for the Parker full line of hydraulic couplings.

Performance

NS Series (3/8" & 1/2")
Test Fluid: Oil - 200 SUS

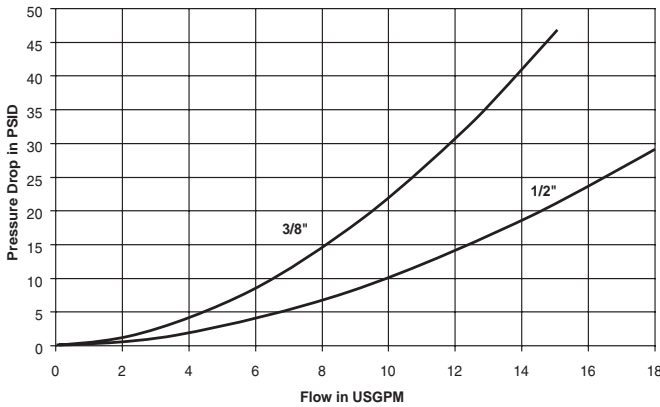

NS Series (3/4" & 1")
Test Fluid: Oil - 200 SUS

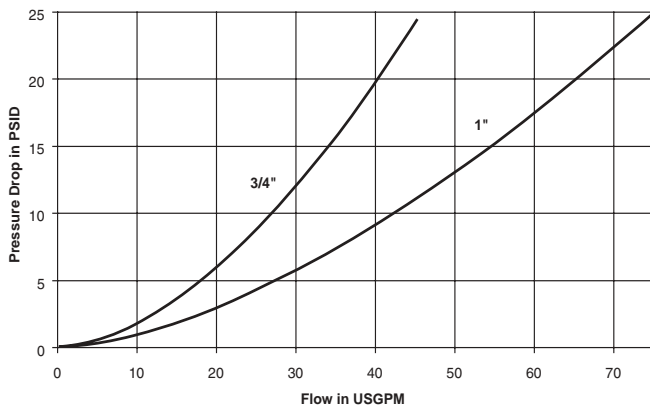

Features

1. Positive valve stop. The perch maintains valve alignment and provides metal to metal valve stop to ensure that the valves open fully, every time.
2. Captive valve seal assures "bubble tight" poppet sealing. The valve seal is positively captured by the metal poppet to minimize seal washout or damage from high velocity fluid.
3. Steel construction, zinc plated with yellow chromate finish. Hardened nipples and sleeves and solid barstock construction for maximum resistance to damage from hydraulic and mechanical shock.
4. The seal is designed to withstand high pressures and provide reliable sealing. 1/2" and above sizes feature PTFE back-up rings that support mating seals for high pressure applications.
5. Durable ball-locking assure reliable connection, every time. A large number of locking balls distribute the work load evenly while providing alignment and swiveling action to reduce hose torque and prolong hose life.

CAUTION: these products are not to be used as swivels, rotation under pressure will result in excessive and premature wear.

6. Female pipe (NPSF), SAE O-Ring Boss and British pipe (BSPF) are available as standard.
7. Dry-Disconnect Series couplings employ flush valving when connecting or disconnecting. This means that the valves are mated together so that only small amounts of fluid can be lost during disconnection or air included during reconnection.
8. Sleeve locking mechanism prevents accidental disconnection when the coupling is dragged along the ground. Sleeve is rotated to engage the lock. The sleeve-lock feature is standard on this product.

Specifications

Body Size (in.)	3/8	1/2	3/4	1
Rated Pressure (PSI)	2500	2500	2500	2500
Rated Flow (GPM)	10	12	30	50
Temperature Range (std seals)	-40° to +250°F			
Spillage (ML) (max. per disconnect)	0.020	0.070	0.150	0.220
Air Incl. (ML) (max. per disconnect)	0.010	0.020	0.050	0.070

Hydraulic Quick Couplings

Non-Spill Couplings NS Series

Couplers

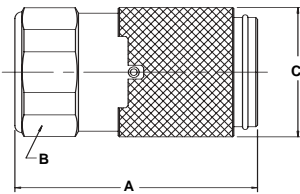

Body Size (in.)	Part No. Steel	Thread Size	Dimensions (in.)			Wt. (LB.) P/Piece
			Overall Length	Hex Size	Largest Diameter	
			A	B	C	
3/8	NS-371-6FP	3/8-18 NPSF	2.10	1.06	1.13	0.36
3/8	NS-371-6FB	G3/8 BSPP	2.10	1.06	1.13	0.38
3/8	NS-371-8FO	3/4-16UNF	2.20	1.06	1.13	0.40
1/2	NS-501-8FP	1/2-14 NPSF	2.88	1.25	1.56	0.80
1/2	NS-501-8FB	G1/2 BSPP	2.95	1.25	1.56	0.74
1/2	NS-501-10FO*	7/8-14UNF	2.97	1.25	1.56	0.80
3/4	NS-751-12FP	3/4-14 NPSF	3.19	1.56	1.96	1.48
3/4	NS-751-12FB	G3/4 BSPP	3.38	1.56	1.96	1.54
3/4	NS-751-12FO	1 1/16-12UN	3.51	1.56	1.96	1.58
1	NS-1001-16FP	1-11 1/2 NPSF	3.70	1.75	2.25	2.35
1	NS-1001-16FB	G 1 BSPP	3.81	1.75	2.25	2.36
1	NS-1001-16FO	1 5/16-12UN	3.81	1.75	2.25	2.36

* Contact factory for Connect-Under-Pressure option availability in the 1/2" size.

Nipples

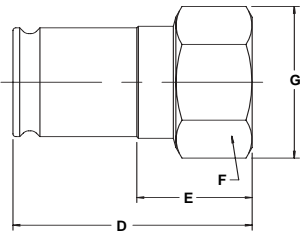

Body Size (in.)	Part No. Steel	Thread Size	Dimensions (in.)				Wt. (LB.) P/Piece
			Overall Length	Exposed* Length	Hex Size	Largest Diameter	
			D	E	F	G	
3/8	NS-372-6FP	3/8-18 NPSF	1.70	1.17	0.94	1.08	0.16
3/8	NS-372-6FB	G3/8 BSPP	1.78	1.25	0.94	1.08	0.16
3/8	NS-372-8FO	3/4-16UNF	1.91	1.38	1.06	1.23	0.20
1/2	NS-502-8FP	1/2-14 NPSF	1.81	0.69	1.06	1.23	0.20
1/2	NS-502-8FB	G1/2 BSPP	1.95	0.83	1.06	1.23	0.22
1/2	NS-502-10FO	7/8-14UNF	2.14	1.02	1.12	1.30	0.28
3/4	NS-752-12FP	3/4-14 NPSF	2.25	1.12	1.37	1.59	0.48
3/4	NS-752-12FB	G3/4 BSPP	2.47	1.34	1.37	1.59	0.54
3/4	NS-752-12FO	1 1/16-12UN	2.62	1.49	1.37	1.59	0.65
1	NS-1002-16FP	1-11 1/2 NSPF	2.64	1.54	1.62	1.88	0.72
1	NS-1002-16FB	G 1 BSPP	2.78	1.68	1.62	1.88	0.74
1	NS-1002-16FO	1 5/16-12UN	2.87	1.77	1.62	1.88	0.80

* This dimension represents the portion that is exposed when the nipple is inserted into the mating Parker Coupler.

Standard Port Configurations

- FP - Female Pipe Thread
- FO - Female Straight Thread
- FB - Female British Standard Pipe Parallel

Optional Seals



Optional Seals Suffix	
E4	Fluorocarbon
E5	Ethylene Propylene (EPR)
E35	Perfluoroelastomer (Contact factory for Seal options)

Hydraulic Quick Couplings

Non-Spill Adapters

Applications

Parker Non-Spill Adapters were designed due to the widespread use of several coupling types in the construction market. These adapters help the user adapt between poppet style couplings and non-spill type couplings. Adapters are widely available with Parker FE and FF Series to Parker 6600 Series coupling connections. This product is especially useful where multiple hydraulic attachments are being used with skid steer loaders.

Materials Of Construction

Body: Steel
 Finish: Zinc plated with yellow chromate finish

Specifications

Body Size (in.)	1/2
Rated Pressure (PSI) – EAS/SAE	3625
Rated Pressure (PSI) – FAS/SAF	3000
Temperature Range	-40° to + 250°F
Max Spillage Per Disconnect (ml.) (Flush Face End)	.020
Max Air Inclusion Upon Connect (ml.) (Flush Face End)	.070
Rated Flow (GPM)	12

Adapters

EAS-500

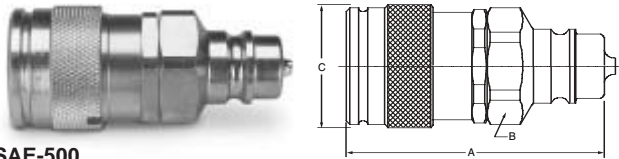

SAE-500

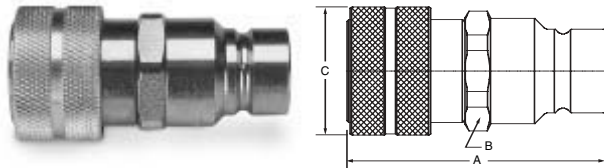

FAS-500

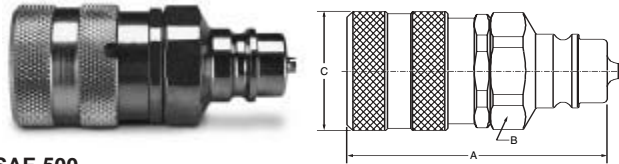

SAF-500

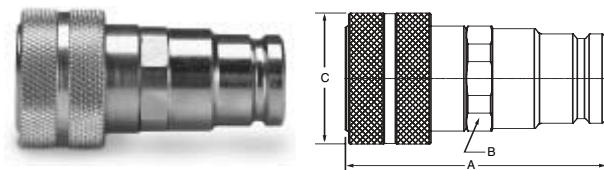

How To Order

Adapter Part Number

E A S – 500

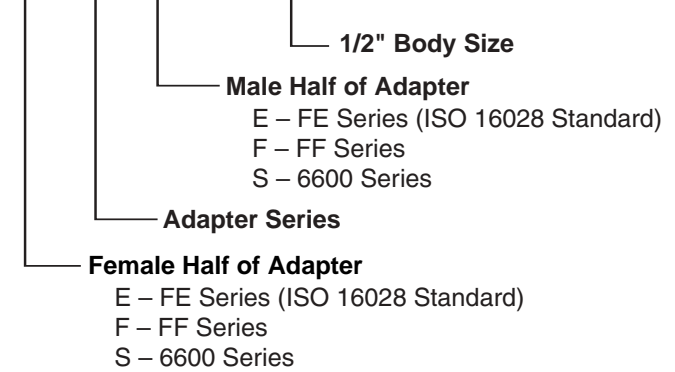

Body Size	Part Number	Thread Size	Overall Length		
			A	B	C
1/2	EAS-500	NA	3.364	1.380	1.50
1/2	SAE-500	NA	3.000	1.250	1.48
1/2	FAS-500	NA	3.390	1.380	1.54
1/2	SAF-500	NA	2.95	1.125	1.48

Performance

FE/FF to 6600 Adapter (1/2")
 Test Fluid: Oil - 200 SUS

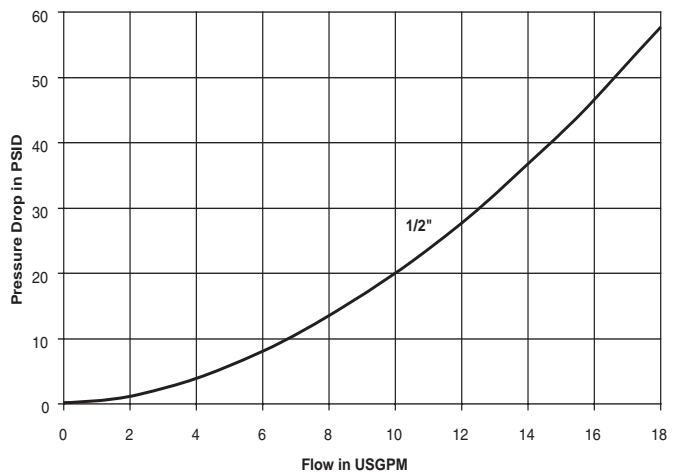

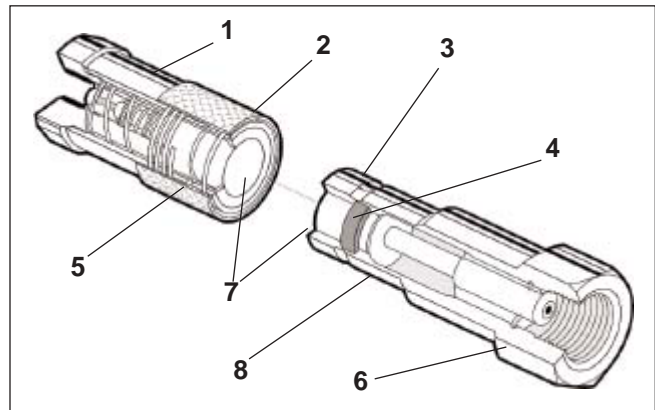

Applications

Parker FF Series couplings are widely used in the public utility market where hydraulic oil spillage can constitute a serious safety hazard, particularly in overhead bucket hoists that are used for maintenance of high-voltage power transmission lines. These couplings are also used for quick change of hydraulic tools in construction, railway maintenance and mining industries. The ease of cleaning makes them ideal for use in these types of hostile environments.

Note: See pages noted in Table of Contents for dust plugs and caps for the Parker full line of hydraulic couplings.

Performance

FF Series (1/4", 3/8", 1/2")
Test Fluid: Oil - 200 SUS

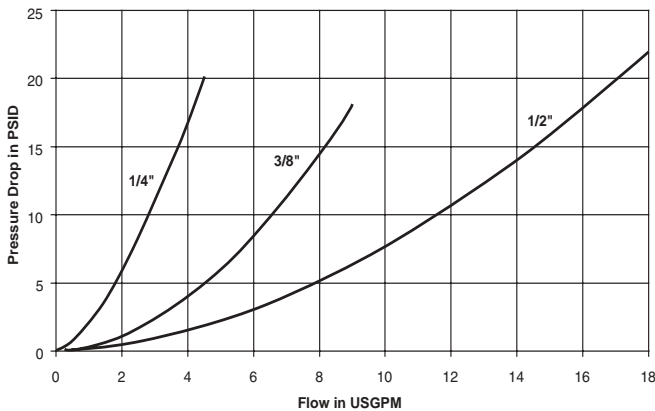

FF Series (3/4" & 1")
Test Fluid: Oil - 200 SUS

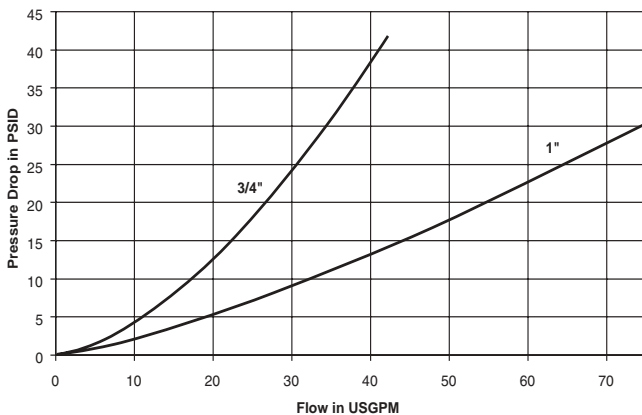

Features

1. Sleeve locking mechanism is engaged by rotating sleeve after connection. It prevents accidental disconnection when, for example, the coupling is dragged along the ground during use.
2. Sleeve mechanism is designed to help prevent dirt from entering the internal mechanism and thus causing faulty operation when connecting or disconnecting. The sleeve covers the retaining ring and also incorporates a dust seal in the spring area.
3. Steel construction, zinc plated with yellow chromate finish. Hardened nipples and sleeves and solid barstock construction for maximum resistance to damage from hydraulic and mechanical shock.
4. This Anti-Blowout Nitrile/PTFE bonded seal is designed to prevent blow-out or damage during severe service conditions.
5. Durable ball-locking mechanism assures reliable connections, every time. A large number of locking balls distributes the work load evenly while providing alignment and swiveling action to reduce hose torque and prolong hose life. CAUTION: These products are not to be used as swivels. Rotation under pressure will result in excessive and premature wear.
6. Female pipe (NPSF), British pipe (BSPP) and SAE O-Ring Boss are available as standard.
7. FF Series couplings employ flush valving when connecting or disconnecting. This means that the valves are mated together so that only small amounts of fluid can be lost during disconnection or air inclusion during reconnection.
8. The 3/8" size conforms to HTMA (Hydraulic Tool Manufacturers Association) standards. All sizes incorporate flush face mating surfaces which greatly facilitate cleaning of the product when disconnected. HTMA couplings (3/8" only)-coupler and nipple are marked with a directional flow arrow as per specifications. However, couplings are bi-directional.

Specifications

Body Size (in.)	1/4	3/8	1/2	3/4	1
Rated Pressure (PSI)	5000	3000	3000	3000	3000
Rated Flow (GPM)	3	6	12	28	50
Temperature Range	-40° to + 250°F				
Spillage (ML) (max. per disconnect)	.015	.015	.020	.150	.200
Air Inclusion (ML) (max. per connect)	.020	.020	.070	.100	.150

Hydraulic Quick Couplings

Non-Spill Couplings FF Series

Couplers

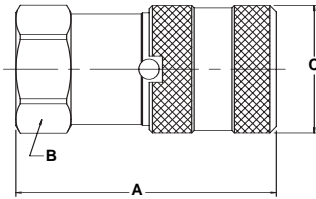

Body Size (in.)	Part No. Steel	Thread Size	Dimensions (in.)			Wt. (LB.) P/Piece
			Overall Length	Hex Size	Largest Diameter	
			A	B	C	
1/4	FF-251-4FP	1/4-18 NPSF	1.79	1.00	1.06	0.23
1/4	FF-251-4MP	1/4-18 NPTF	1.84	1.00	1.06	0.24
1/4	FF-251-6FO	9/16-18 UNF	1.91	1.00	1.06	0.23
3/8	FF-371-6FP	3/8-18 NPSF	2.39	1.06	1.20	0.44
3/8	FF-371-8FP	1/2-14 NPSF	2.80	1.06	1.20	0.50
3/8	FF-371-6FB	G3/8 BSPP	2.45	1.06	1.20	0.45
3/8	FF-371-8FB	G1/2 BSPP	2.80	1.06	1.20	0.48
3/8	FF-371-8FO	3/4-16 UNF	2.82	1.06	1.20	0.52
1/2	FF-501-8FP	1/2-14 NPSF	2.67	1.37	1.58	0.88
1/2	FF-501-10FO	7/8-14 UNF	2.89	1.37	1.58	1.05
3/4	FF-751-12FP	3/4-14 NPSF	3.50	1.75	1.94	1.84
3/4	FF-751-12FO	1 1/16-12 UNF	3.75	1.75	1.94	1.93
1	FF-1001-16FP	1-11 1/2NPSF	4.14	1.87	2.25	2.64
1	FF-1001-16FO	1 5/16-12UNF	4.24	1.87	2.25	2.68

Nipples

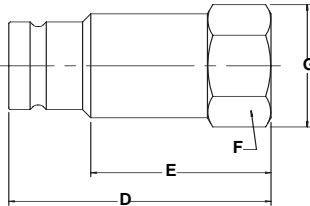

Body Size (in.)	Part No. Steel	Thread Size	Dimensions (in.)				Wt. (LB.) P/Piece
			Overall Length	Exposed* Length	Hex Size	Largest Diameter	
			D	E	F	G	
1/4	FF-252-4FP	1/4-18 NPSF	1.66	1.15	1.00	1.06	0.16
1/4	FF-252-4MP	1/4-18 NPTF	1.72	1.18	1.00	1.06	0.26
1/4	FF-252-6FO	9/16-18 UNF	1.66	1.15	1.00	1.06	0.16
3/8	FF-372-6FP	3/8-18 NPSF	2.31	1.71	0.94	1.08	0.26
3/8	FF-372-8FP	1/2-14 NPSF	2.64	2.04	1.06	1.19	0.32
3/8	FF-372-6FB	G3/8 BSPP	2.45	1.86	0.94	1.08	0.28
3/8	FF-372-8FB	G1/2 BSPP	2.70	2.16	1.06	1.19	0.32
3/8	FF-372-8FO	3/4-16 UNF	2.70	2.16	1.06	1.19	0.30
1/2	FF-502-8FP	1/2-14 NPSF	2.75	2.11	1.12	1.30	0.42
1/2	FF-502-10FO	7/8-14 UNF	2.97	2.29	1.12	1.30	0.44
3/4	FF-752-12FP	3/4-14 NPSF	3.38	2.47	1.50	1.73	1.00
3/4	FF-752-12FO	1 1/16-12 UNF	3.58	2.64	1.50	1.73	1.02
1	FF-1002-16FP	1-11 1/2NPSF	3.85	2.60	1.87	2.17	1.60
1	FF-1002-16FO	1 5/16-12UNF	3.85	2.60	1.87	2.17	1.70

* This dimension represents the portion that is exposed when the nipple is inserted into the mating Parker Coupler.

Standard Port Configurations

- FP - Female Pipe Thread
- MP - Male Pipe Thread
- FO - Female Straight Thread
- FB - Female British Standard Pipe Parallel

Optional Seals



Optional Seals Suffix*

- E4	Fluorocarbon
- E5	Ethylene Propylene (EPR)
- E35	Perfluoroelastomer (Contact Factory for Seal Options).

* Optional seals include O-ring & Back-Up Ring, not Anti-Blow Out bonded seal.

FF Series Repair Kits

1/4" Nipple	3/8" Nipple	1/2" Nipple	3/4" Nipple	1" Nipple	1/4" Coupler	3/8" Coupler	1/2" Coupler	3/4" Coupler	1" Coupler
FF-252-KIT	FF-372-KIT	FF-502-KIT	FF-752-KIT	FF-1002-KIT	FF-251-KIT	FF-371-KIT	FF-501-KIT	FF-751-KIT	FF-1001-KIT
FF-252-KIT-E4	FF-372-KIT-E4	FF-502-KIT-E4	FF-752-KIT-E4	FF-1002-KIT-E4	FF-251-KIT-E4	FF-371-KIT-E4	FF-501-KIT-E4	FF-751-KIT-E4	FF-1001-KIT-E4
FF-252-KIT-E5	FF-372-KIT-E5	FF-502-KIT-E5	FF-752-KIT-E5	FF-1002-KIT-E5	FF-251-KIT-E5	FF-371-KIT-E5	FF-501-KIT-E5	FF-751-KIT-E5	FF-1001-KIT-E5
					FF/FS-251-TOOL	FF/FS-371-TOOL	FF-501-TOOL	FF/FS-751-TOOL	FF/FS-1001-TOOL



B Hydraulics



Applications

Parker FE Series couplings were designed for the construction equipment market and are used extensively on skid steer loaders. The non-spill feature eliminates hydraulic spillage and air inclusion when connecting or disconnecting hydraulic attachments. The FE Series is also ideal for many other applications where hydraulic spillage is a concern and global interchangeability with other manufacturers is important. ISO-16028 Interchange.

Materials Of Construction

- Body:** Steel
- Finish:** Zinc plated with yellow chromate finish
- Valve:** Flush face valving
- Seal:** Anti blow-out Nitrile/PTFE bonded seal (male only)

Specifications

Body Size (in.)	1/2	5/8
Rated Pressure (PSI)	3000	3625
Temperature Range	-40° to + 250°F	
Spillage (ML) (max. per disconnect)	0.020	0.030
Air Inclusion (ML) (max. per connect)	0.070	0.070
Rated Flow (GPM)	12	20

Features

- Sealed spring cavity prevents dust collection and possible sleeve binding.
- Heat treated valve sleeve and poppet resist scratches and wear.
- Crimped valve seal prevents seal washout.
- Hardened locking collar sleeve resists brinelling, avoids cracking and provides longer life.
- Large number of locking balls resists brinelling.
- Concealed lock ring prevents accidental removal.
- Zinc plate with yellow chromate finish resists corrosion.
- Positive lock retaining ring will not wash out under high flow conditions.
- Induction hardened locking surface reduces wear and brinelling.
- Anti-blowout Nitrile/PTFE bonded nipple seal prevents damage and blow-out when connecting with residual pressure.

Performance

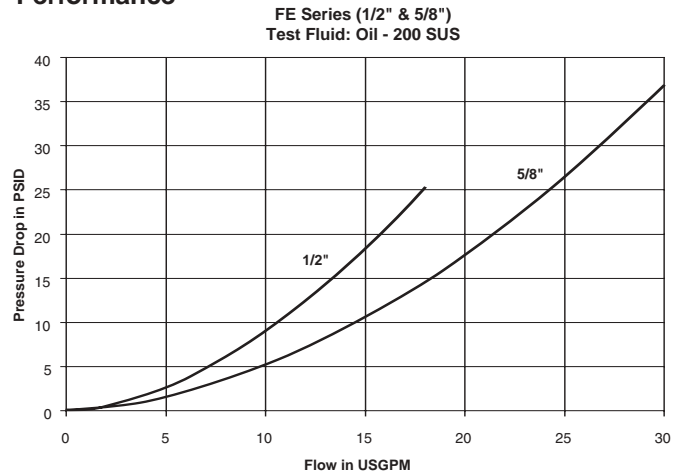

Hydraulic Quick Couplings

Non-Spill Couplings FE Series

Couplers

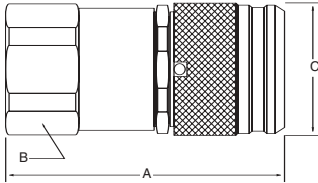

Body Size (in.)	Part No. Steel	Thread Size	Dimensions (in.)			Wt. (LB.) P/Piece
			Overall Length	Hex Size	Largest Diameter	
			A	B	C	
1/2"	FE-501-8FP*	1/2-14 NPSF	2.65	1.38	1.58	0.85
1/2"	FE-501-12FO*	1-1/16-12 UNF	3.10	1.38	1.58	0.90
5/8"	FE-621-12FO*	1-1/16-12 UNF	3.67	1.62	1.74	1.51

* Non Sleeve Lock available – add “-NL” to part number

Nipples

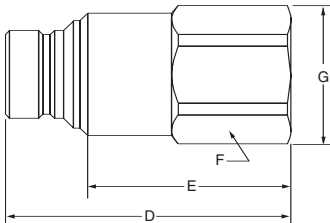

Body Size (in.)	Part No. Steel	Thread Size	Dimensions (in.)				Wt. (LB.) P/Piece
			Overall Length	Exposed Length	Hex Size	Largest Diameter	
			D	E	F	G	
1/2"	FE-502-8FP	1/2-14 NPSF	2.77	1.96	1.25	1.38	0.55
1/2"	FE-502-12FO	1-1/16-12 UNF	3.05	2.20	1.38	1.50	0.56
5/8"	FE-622-12FO	1-1/16-12 UNF	3.40	2.60	1.50	1.65	0.95

Standard Port Configurations

FP - Female Pipe Thread
FO - Female Straight Thread



Features

- Meets or exceeds ISO 16028 specification design and test requirements.
- Wider size variations and increased pressures over FE couplers.
- ISO-16028 Interface for universal interchangeability.
- Modular design for increased flexibility with fitting port options.
- Brinell relief on male half to increase life and resist wear.
- Induction hardened locking surface to resist brinelling, damage and abuse.
- Heat Treated components to resist scratches and wear.
- Smooth flow path for low pressure drop.
- Heavy locking collar to resist damage and abuse.
- Anti-blowout Nitrile/PTFE bonded male half seal prevents damage and premature failure with residual system pressure.
- Optional Color coding bands for system identification.
- Crimped valve seal prevents seal washout.
- Steel guide to resist damage on breaker applications.
- Push-to-connect locking mechanism.
- Optional sleeve lock.

Specifications

Body Size (in.)	1/4	3/8	1/2	5/8	3/4	1
Rated Pressure (PSI)	4568	3625	3625	3625	3625	2900
Rated Flow (GPM)	3	6	12	20	26	50
Temperature Range (std.seals)	-40 to +250° F					
Spillage (ML) (max. per disconnect)	0.015	0.015	0.020	0.030	0.150	0.200
Air Inclusion (ML) (max. per connect)	0.020	0.020	0.070	0.070	0.100	0.150

Applications

Parker FEM Series couplings are designed to meet the stringent design and pressure requirements of ISO 16028. The FEM modular design also facilitates wider variations in fitting options. Parker FEM couplers are designed for use in the construction, utility and agricultural equipment markets. As with all Parker flush-face designs the non-spill feature eliminates hydraulic spillage and air inclusion when connecting or disconnecting hydraulic attachments. The FEM Series is also ideal for many other applications where hydraulic spillage is a concern and global interchangeability with other manufacturers is important.

Materials of Construction

- Body:** Steel
- Finish:** Zinc plated with yellow chromate finish
- Valve:** Flush face valving
- Seal:** Anti blow-out Nitrile/PTFE bonded seal (male only)

Performance

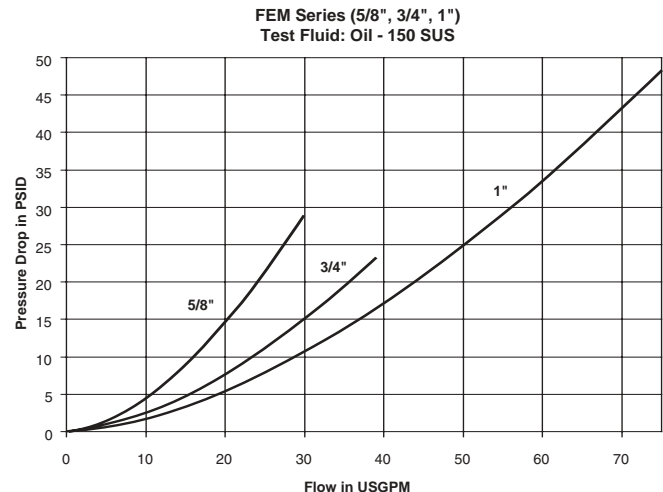
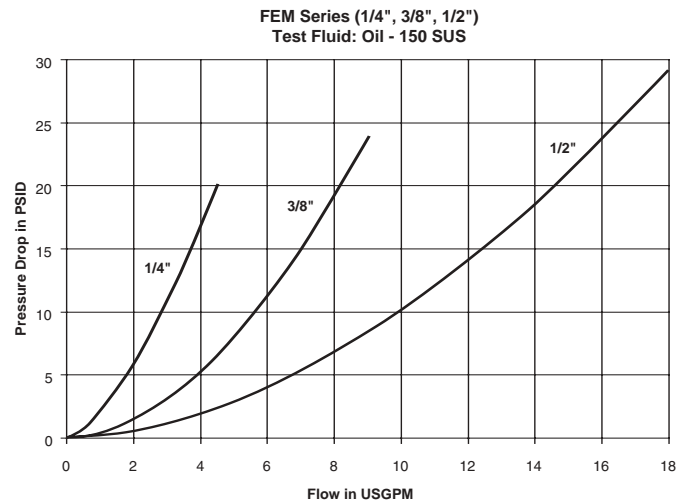

Couplers

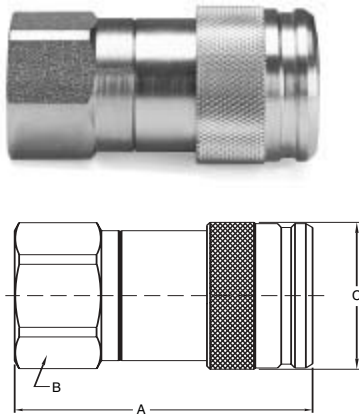

Body Size (in.)	Part Number	Thread Size	Overall Length	Hex Size	Largest Diameter	Wt. (LB) P/Piece
			A	B	C	
1/4	FEM-251-4FP-NL	.250-18 NPSF	1.96	1.00	1.06	0.25
3/8	FEM-371-6FP-NL	.375-18 NPSF	2.89	1.06	1.19	0.51
3/8	FEM-371-8FO-NL	.750-16 UNF	2.89	1.06	1.19	0.51
1/2	FEM-501-8FP-NL	.500-14 NPSF	3.04	1.06	1.19	0.93
1/2	FEM-501-10BMS-NL	1.000-14 UNS	4.02	1.38	1.58	0.95
1/2	FEM-501-10BMF-NL	.875-14 UNF	4.03	1.38	1.58	0.93
1/2	FEM-501-10FO-NL	.875-14 UNF	3.04	1.25	1.58	0.93
1/2	FEM-501-12FO-NL	1.062-12 UN	3.24	1.38	1.58	0.93
5/8	FEM-621-12FO-NL	1.062-12 UNF	3.70	1.50	1.70	1.40
3/4	FEM-751-12FP-NL	.750-14 NPSF	3.95	1.75	1.95	2.04
3/4	FEM-751-12FO-NL	1.062-12 UNF	3.95	1.75	1.95	2.04
1	FEM-1001-16FP-NL	1.000-11.5 NPSF	4.21	2.00	2.25	2.70
1	FEM-1001-16FO-NL	1.312-12 UNF	4.21	2.00	2.25	2.70

Nipples

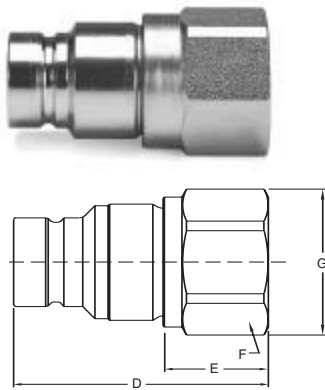

Body Size (in.)	Part Number	Thread Size	Overall Length	Exposed Length*	Hex Size	Largest Diameter	Wt. (LB) P/Piece
			D	E	F	G	
1/4	FEM-252-4FP	.250-18 NPSF	1.71	1.25	1.00	1.06	0.17
3/8	FEM-372-6FP	.375-18 NPSF	2.48	1.83	1.06	1.16	0.32
3/8	FEM-372-8FO	.750-16 UNF	2.48	1.83	1.06	1.16	0.32
1/2	FEM-502-8FP	.500-14 NPSF	2.85	2.15	1.38	1.50	0.54
1/2	FEM-502-10FO	.875-14 UNF	2.85	2.15	1.38	1.50	0.54
1/2	FEM-502-10BMS	1.000-14 UNS	3.84	3.14	1.38	1.50	0.56
1/2	FEM-502-10BMF	.875-14 UNF	3.85	3.15	1.38	1.50	0.54
1/2	FEM-502-12FO	1.062-12 UN	3.05	2.35	1.38	1.50	0.54
5/8	FEM-622-12FO	1.062-12 UN	3.09	2.39	1.50	1.65	0.76
3/4	FEM-752-12FP	.750-14 NPSF	3.38	2.46	1.75	1.94	1.12
3/4	FEM-752-12FO	1.062-12 UN	3.38	2.46	1.75	1.94	1.12
1	FEM-1002-16FP	1.000-11.5 NPSF	3.85	2.93	2.00	2.25	1.72
1	FEM-1002-16FO	1.312-12 UN	3.85	2.93	2.00	2.25	1.72

* This dimension represents the portion that is exposed when the nipple is inserted into the mating Parker Coupler.

Standard Port Configurations

- FP** - Female Pipe Thread
- FO** - Female Straight Thread
- BMF** - Bulkhead Male Flare 37° JIC
- BMS** - Bulkhead Male Seal-lok

Other Fitting Port Configurations available upon request.



Description

FC Series products operate slightly different from traditional non-spill couplings. With no pressure in the coupler and up to 3000 PSI of trapped pressure in the nipple, begin to couple the mating halves. Delay momentarily during connection to allow trapped pressure to equalize with the mating half before completing the connection.

Performance

FC Series (3/8", 1/2", 3/4")
Test Fluid: Oil - 200 SUS

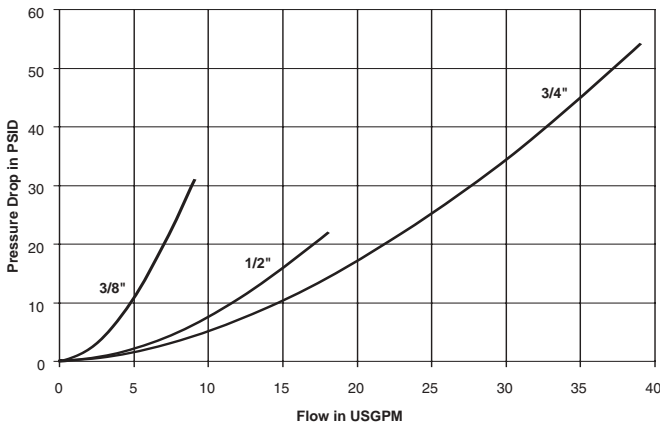

Applications

Parker FC Series nipple provides connect-under-pressure capability with up to 3000 PSI of trapped pressure in the nipple and are ideal for applications where residual pressure makes reconnect difficult. Utilized primarily in the construction equipment market, FC Series products are commonly found on hydraulic attachments used in skid steer applications. **The FC Series mates with the FF Series Parker interface.**

Features

- Connect-Under-Pressure nipple only.
- Hardened locking surface.
- Steel construction, zinc plated with yellow chromate finish for corrosion resistance.
- Anti Blowout Nitrile/PTFE bonded nipple seal.
- Flush Face Valving

Note: Protective dust plugs and caps play a crucial role in the life of a quick coupling and no purchase of a hydraulic quick coupling is complete without the selection of an appropriate dust plug and cap. See pages noted in Table of Contents for dust plugs and caps for the Parker full line of hydraulic couplings.

Specifications

Body Size (in.)	3/8	1/2	3/4
Rated Pressure (PSI)	3000	3000	3000
Rated Connect-Under-Pressure Capability	3000	3000	1500
Rated Flow (GPM)	6	12	26
Spillage (ML) (max. per disconnect)	.015	.020	.015
Air Inclusion (ML) (max. per connect)	.020	.070	.100

Nipples

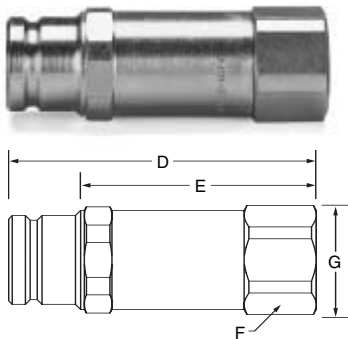

Body Size (in.)	Part No. Steel	Mating Half	Thread Size	Dimensions (in.)				Wt. (LB.) P/Piece
				Overall Length	Exposed Length	Hex Size	Largest Diameter	
				D	E	F	G	
3/8	FC-372-6FP	FF-371	3/8-18 NPSF	3.30	2.58	1.062	1.16	0.45
3/8	FC-372-8FO	FF-371	3/4-16 UNF	3.30	2.58	1.062	1.16	0.42
3/8	FC-372-8FP	FF-371	1/2-14 NPSF	3.30	2.58	1.062	1.16	0.42
1/2	FC-502-8FP	FF-501	1/2-14 NPSF	3.46	2.65	1.125	1.22	0.53
1/2	FC-502-10FO	FF-501	7/8-14 UNF	3.46	2.65	1.125	1.22	0.52
3/4	FC-752-12FO	FF-751	1 1/16-12 UNF	4.81	3.72	1.500	1.65	1.32
3/4	FC-752-12FP	FF-751	3/4-14 NPSF	4.81	3.72	1.500	1.65	1.34

Standard Port Configurations

- FP - Female Pipe Thread
- FO - Female Straight Thread

Hydraulic Quick Couplings

Non-Spill Couplings

FEC Series (Connect-Under-Pressure)



Description

FEC Series products operate slightly different from traditional non-spill couplings. With no pressure in the coupler and up to 3000 PSI of trapped pressure in the nipple, begin to couple the mating halves. Delay momentarily during connection to allow trapped pressure to equalize with the mating half before completing the connection.

Performance

FEC Series (1/2", 5/8", 3/4", 1")
Test Fluid: Oil - 200 SUS

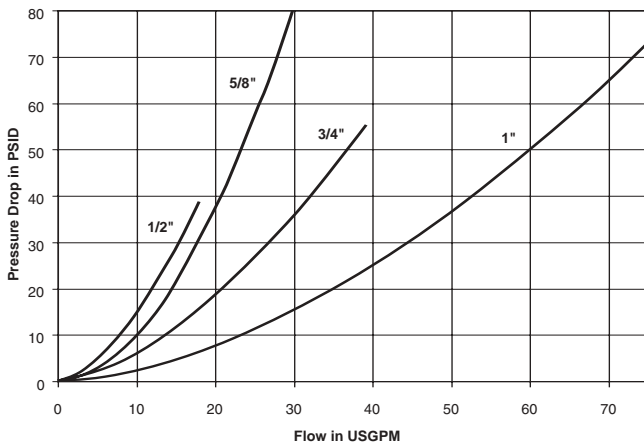

Nipples

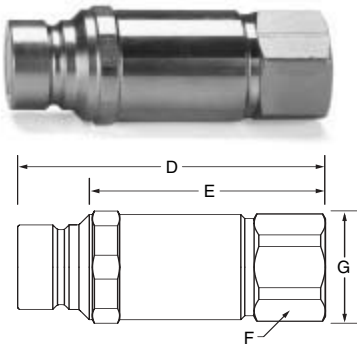

Body Size (in.)	Part No. Steel	Mating Half	Thread Size	Dimensions (in.)				Largest Diameter	Wt. (LB.) P/Piece
				Overall Length	Exposed Length	Hex Size	G		
1/2	FEC-502-8FP	FE-501	1/2-14 NPSF	3.50	2.68	1.125	1.22		
1/2	FEC-502-10FO	FE-501	7/8-14 UNF	3.50	2.68	1.125	1.22		
1/2	FEC-502-12FO	FE-501	1 1/16-12 UNF	3.79	2.97	1.500	1.65		
5/8	FEC-622-12FO	FEM-621	1 1/16-12 UN	4.19	3.39	1.500	1.65		
3/4	FEC-752-12FO	FEM-751	1 1/16-12 UN	4.84	3.76	1.500	1.65		
1	FEC-1002-16FP	FEM-1001	1-11 1/2 NPSF	5.35	4.15	1.88	2.06		
1	FEC-1002-16FO	FEM-1001	1 5/16-12 UN	5.35	4.15	1.88	2.06		

Standard Port Configurations

FP - Female Pipe Thread

FO - Female Straight Thread

Applications

Parker FEC Series nipple provide connect-under-pressure capability with up to 3000 PSI of trapped pressure in the nipple and are ideal for applications where residual pressure makes reconnect difficult. Utilized primarily in the construction equipment market, FEC Series products are commonly found on hydraulic attachments used in skid steer applications. **The FEC Series mates with the FE and FEM Series European interface ISO 16028 couplers.**

Features

- Connect-Under-Pressure nipple.
- Hardened locking surface.
- Steel construction, zinc plated with yellow chromate finish for corrosion resistance.
- Anti blowout Nitrile/PTFE bonded nipple seal.
- Flush face valving.

Note: Protective dust plugs and caps play a crucial role in the life of a quick coupling and no purchase of a hydraulic quick coupling is complete without the selection of an appropriate dust plug and cap. See pages noted in Table of Contents for dust plugs and caps for the Parker full line of hydraulic couplings.

Specifications

Body Size (in.)	1/2	5/8	3/4	1
Rated Pressure (PSI)	3625	3625	3625	2900
Rated Connect-Under-Pressure Capability	3000	1700	1500	1000
Rated Flow (GPM)	12	20	26	50
Spillage (ML) (max. per disconnect)	0.020	0.03	0.150	0.20
Air Inclusion (ML) (max. per connect)	0.070	0.070	0.100	0.150



Description

Parker FH Series high pressure couplings are an innovative product combining the advantages of a flush-face design with a highly technical performance of a rated pressure of 10,000 PSI. For safety purposes, this product does not interchange with flush-face couplings having a lower pressure rating.

Performance

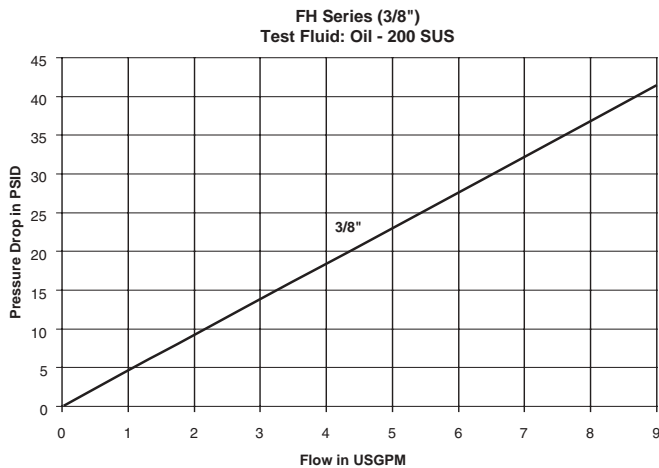

Features

- 10,000 PSI operating pressure (700 bar).
- Flush face, non-spill valving, both halves.
- Sleeve on coupler and nipple body have a RED finish for identification purposes.
- Simple Push-To-Connect operation.
- Sleeve-Lock to prevent accidental disconnect.
- Non interchangeable with low pressure flush face couplings.
- Meets performance and dimensional specifications of HTMA requirements, 10,000 PSI (700 bar).
- Anti Blow-Out Nitrile/PTFE bonded nipple seal.

Applications

- Hydraulic Crimpers, Cutters, Jacks, Benders, Clamps, Wedges
- Rescue Equipment
- High Pressure Test Equipment

Note: Protective dust plugs and caps play a crucial role in the life of a quick coupling and no purchase of a hydraulic quick coupling is complete without the selection of an appropriate dust plug and cap. See pages noted in Table of Contents for dust plugs and caps for the Parker full line of hydraulic couplings.

Materials of Construction

- Body:** Steel
- Finish:** Zinc Plated with yellow Chromate.
Sleeve and Nipple plated with Red Chromate.
- Valve:** Flush Face Valves
- Seal:** Anti blow-out Nitrile/PTFE bonded seal (nipple only)

Specifications

Body Size (in.)	3/8
Rated Pressure (PSI)	10,000
Rated Flow (GPM)	6
Temperature Range	-40° to +250° F
Spillage (ML) (max. per disconnect)	.020
Air Inclusion (ML) (max. per connect)	.070

Hydraulic Quick Couplings

Non-Spill Couplings FH Series

Couplers

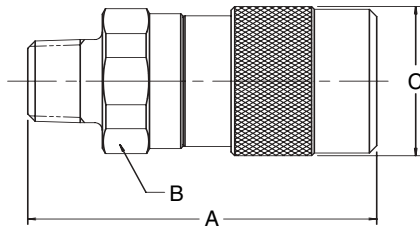

Body Size (in.)	Part No. Steel	Thread Size	Overall Length	Wrench Flats	Dimensions (in.)		Wt. (LB.) P/Piece
					A	B	
3/8	FH-371-6FP	3/8 -18 NPTF	2.63	1.12	1.23	0.44	
3/8	FH-371-6MP	3/8 -18 NPTF	2.85	1.12	1.23	0.45	
3/8	FH-371-6FB	G3/8 -BSPP	2.55	1.12	1.23	0.45	

Nipples

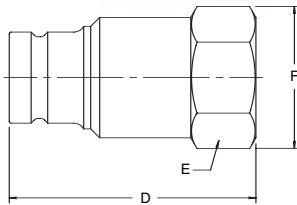

Body Size (in.)	Part No. Steel	Thread Size	Overall Length	Wrench Flats	Dimensions (in.)		Wt. (LB.) P/Piece
					D	E	
3/8	FH-372-6FP	3/8-18 NPTF	2.12	1.00	1.23	0.26	
3/8	FH-372-6FB	G3/8 -BSPP	2.12	1.00	1.23	0.28	

Standard Port Configurations

FP - Female Pipe Thread

MP - Male Pipe Thread

FB - Female British Standard Parallel



Applications

Parker FS Series couplings virtually eliminate fluid loss upon disconnection, and minimize air inclusion during connections. They are ideal for use where spillage may cause undesirable conditions or constitute a safety hazard. The FS Series couplings have double shut-off flush mating valves that are suitable for sealing off media in chemical processing, chemical dispensing, food processing, and other corrosive applications. Working pressures to 2000 PSI.

Note: Protective dust plugs and caps play a crucial role in the life of a quick coupling and no purchase of a hydraulic quick coupling is complete without the selection of an appropriate dust plug and cap. See pages noted in Table of Contents for dust plugs and caps for the Parker full line of hydraulic couplings.

Specifications

Body Size (in.)	1/4	3/8	1/2	3/4	1
Rated Pressure (PSI)	2000	2000	2000	2000	2000
Rated Flow (GPM)	3	6	12	28	50
Spillage (ML) (max. per disconnect)	.015	.015	.020	.150	.250
Air Inclusion (ML) (max. per connect)	.010	.020	.070	.100	.182
CV	0.9	1.8	3.0	7.0	10.1

Temperature Range (continuous)		
Part No. Seal Suffix	Seal Compound	Temp°F Rating
None*	Fluorocarbon	-15 to 400
E5	Ethylene Propylene (EPR)	-65 to 300
E1	Nitrile	-40 to 250
E35	Perfluoroelastomer (Contact Factory)	-20 to 600

*Fluorocarbon is standard seal.

Features

- Simple to operate: Push to connect, pull on knurled sleeve to disconnect.
- Flush face valves exhibit minimal spillage upon disconnect and minimal air inclusion upon connect.
- Superior locking ball design – a large number of locking balls distribute the workload better and allow for some rotation between the male and female halves of the coupling under pressure.
- Excellent flow vs pressure drop characteristics when compared with other low spill quick couplings.
- Material construction is 316 stainless steel with fluorocarbon seals as standard.
- Wide range of seal materials available.
- Repair kits available to replace critical elastomer seals (all sizes).

Materials of Construction

- Machined Parts:** Stainless Steel, AISI type 316
- Springs:** Stainless Steel, AISI type 316.
- Locking Balls:** 1/4" - 302 SS;
3/8" - 1" - Tungsten Carbide
- Backup Washers:** PTFE
- Elastomer Seals:** Fluorocarbon is standard.
Wide range is available.

Performance Flow Data

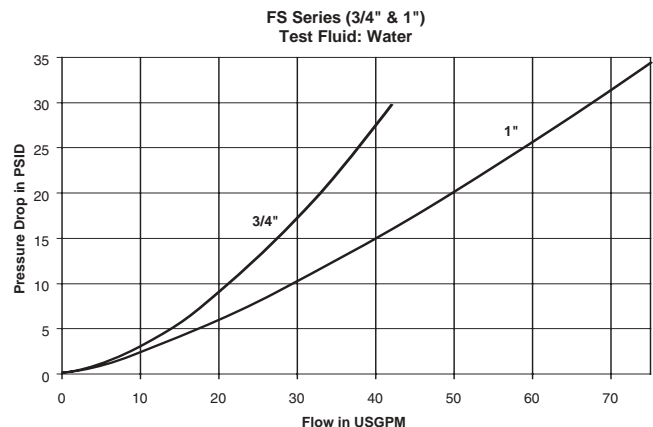
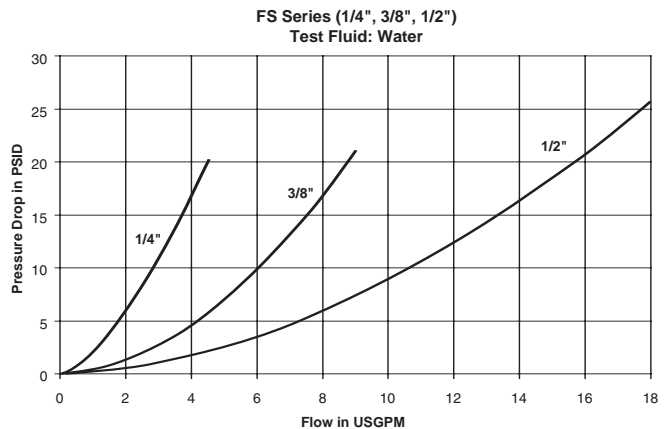

Hydraulic Quick Couplings

Non-Spill Couplings FS Series

Couplers

Female Pipe Thread

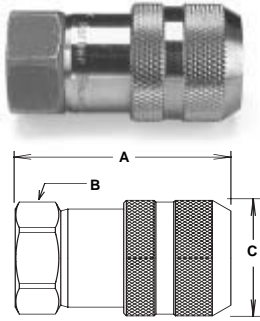

Body Size (in.)	Part No.	Thread Size	Overall Length	Hex Size	Largest Diameter	Wt. (LB.) P/Piece
			A	B	C	
1/4	FS-251-4FP	1/4-18 NPT	1.79	1.00	1.06	0.25
1/4	FS-251-4MP	1/4-18 NPTF	2.00	1.00	1.06	0.25
1/4	FS-251-6FO	9/16-18UNF	1.92	1.00	1.06	0.24
3/8	FS-371-6FP	3/8-18 NPT	2.52	1.06	1.30	0.58
3/8	FS-371-8FO	3/4-16 UNF	2.83	1.12	1.30	0.63
1/2	FS-501-8FP	1/2-14 NPT	2.74	1.38	1.58	0.92
1/2	FS-501-10FO	7/8-14 UNF	2.86	1.38	1.58	0.96
3/4	FS-751-12FP	3/4-14 NPT	3.63	1.75	1.99	2.00
3/4	FS-751-12FO	1-1/16-12 UNF	3.73	1.75	1.99	2.12
1	FS-1001-16FP	1-11 1/2 NPT	4.14	1.87	2.25	2.76
1	FS-1001-16FO	1-5/16-12 UNF	4.24	1.87	2.25	2.80

Nipples

Female Pipe Thread

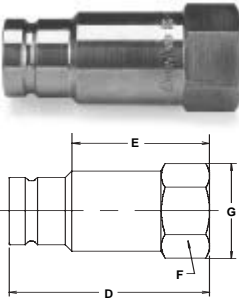

Body Size (in.)	Part No.	Thread Size	Overall Length	Exposed Length	Hex Size	Largest Diameter	Wt. (LB.) P/Piece
			D	E	F	G	
1/4	FS-252-4FP	1/4-18 NPT	1.66	1.14	1.00	1.06	0.18
1/4	FS-252-4MP	1/4-18 NPTF	1.87	1.34	1.00	1.06	0.18
1/4	FS-252-6FO	9/16-18 UNF	1.66	1.26	1.00	1.06	0.17
3/8	FS-372-6FP	3/8-18 NPT	2.31	1.71	.94	1.08	0.26
3/8	FS-372-8FO	3/4-16 UNF	2.45	1.71	1.06	1.19	0.30
1/2	FS-502-8FP	1/2-14 NPT	2.75	2.11	1.12	1.30	0.44
1/2	FS-502-10FO	7/8-14 UNF	2.85	2.03	1.12	1.30	0.48
3/4	FS-752-12FP	3/4-14 NPT	3.38	2.47	1.50	1.73	1.02
3/4	FS-752-12FO	1-1/16-12 UNF	3.38	2.27	1.50	1.73	1.14
1	FS-1002-16FP	1-11 1/2 NPT	3.89	2.60	1.87	2.17	1.60
1	FS-1002-16FO	1-5/16 12 UNF	3.89	2.51	1.87	2.17	1.64

Standard Port Configurations

- FP - Female Pipe Thread
- MP - Male Pipe Thread
- FO - Female Straight Thread

FS Series Repair Kits

Repair kits are available for both coupler and nipple half of FS coupling. Kits include replacement elastomer seals, valve assembly and instructions to perform rebuild. Spline tool must be ordered separately to accomplish coupler half repair. Other tools required: Vise, Allen Wrench and Open End Wrench.



FS Repair Kits		Replacement Seals	
TOOL Spline tool for Coupler Repair	No Suffix	Fluorocarbon Seals	
	E5	Ethylene Propylene (EPR)	
	E35	Perfluoroelastomer (Contact the Factory)	

Nipple Repair Kits

1/4" Nipple	3/8" Nipple	1/2" Nipple	3/4" Nipple	1" Nipple
FS-252-KIT	FS-372-KIT	FS-502-KIT	FS-752-KIT	FS-1002-KIT
FS-252-KIT-E5	FS-372-KIT-E5	FS-502-KIT-E5	FS-752-KIT-E5	FS-1002-KIT-E5

Coupler Repair Kits

1/4" Coupler	3/8" Coupler	1/2" Coupler	3/4" Coupler	1" Coupler
FS-251-KIT	FS-371-KIT	FS-501-KIT	FS-751-KIT	FS-1001-KIT
FS-251-KIT-E5	FS-371-KIT-E5	FS-501-KIT-E5	FS-751-KIT-E5	FS-1001-KIT-E5
FF/FS-251-TOOL	FF/FS-371-TOOL	FS-501-TOOL	FF/FS-751-TOOL	FF/FS-1001-TOOL



Applications

Parker's 6100 Series, is a thread-to-connect low spill coupling that can be used in a wide range of industrial applications where connected under pressure is required. The 6100 is ideal for connecting hydraulic lines on oil field equipment like power tongs, swivels and mobile drilling rigs. It is also widely used on dump trailers to connect the tractor to wet-line hydraulic systems.

The 6100 Series is suitable for many applications where high flow connect under pressure couplings are required. Other uses include: submersible pumps, engine test stands, and bulk liquid CO2 transfer (Special part numbers apply – contact the Division).

Note: Protective dust plugs and caps play a crucial role in the life of a quick coupling and no purchase of a hydraulic quick coupling is complete without the selection of an appropriate dust plug and cap. See pages noted in Table of Contents for dust plugs and caps for the Parker full line of hydraulic couplings.

Specifications

Body Size (in.)	3/4	3/4	1	1-1/4	1-1/2
Dash Number	-08	-12	-16	-20	-24
*Rated Pressure (PSI)					
Female Half	3000	3000	3000	2750	2000
Male Half	3000	3000	3000	2500	2500
Complete Coupling Assembly	3000	3000	3000	2750	2500
Rated Flow (GPM)	12	28	50	76	100
Temperature Range (std seals)	-40° to +250°F.				

* Minimum burst pressure is equal to three times the rated pressure. Not recommended for continuous hydraulic impulse applications at rated pressures.

Performance

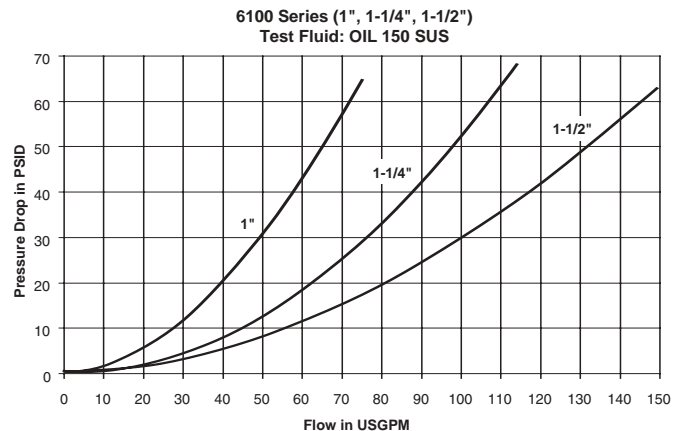
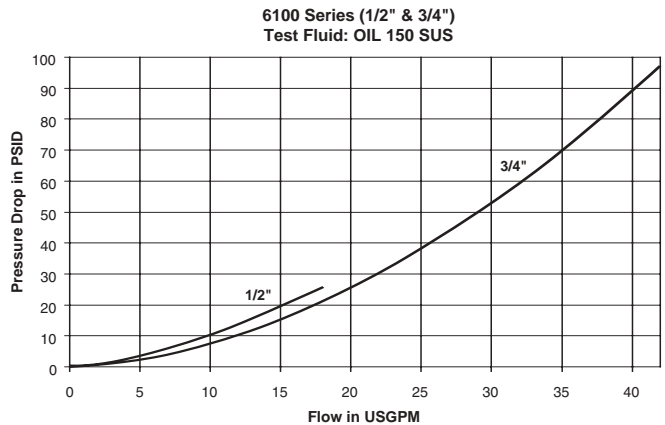

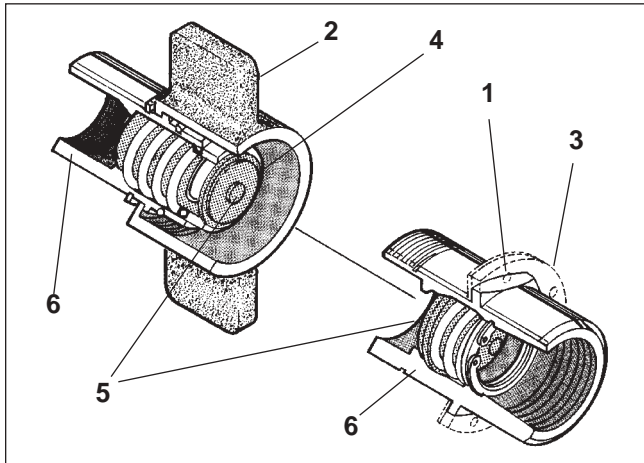

Features

1. The connection indicator, a Parker innovation, serves as a visual check for complete connection of the 6100 coupling. It helps prevent premature failures and leaks. It assures that the connection is complete and the valves fully open, eliminating unnecessary flow restriction. (see drawing on next page)
2. The Parker heavy-duty wing nut is ruggedly built—specifically to withstand the hammer blows commonly used to tighten and loosen this coupler.
3. The flange is designed to give a positive “no-slip” bulkhead mounting to reduce downtime.
4. The bonded valve seal permits full pressure connect and disconnect—without seal washout.
5. The flush face valve keeps air inclusion and spillage to a minimum.
6. Corrosion resistant brass body makes this coupling compatible with a broad range of media and provides versatility.

6100 Series

Coupling with Wingnut

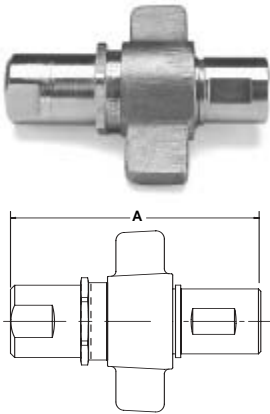

Body Size (in.)	Thread Size NPTF	Part No. With Flange	Part No. Without Flange	Overall Connected Length	Wt. (LB.) P/Piece
A					
3/4	1/2-14	6100-08	6120-08	5.20	2.12
3/4	3/4-14	6100-12	6120-12	5.20	3.27
1	1-11 1/2	6100-16	6120-16	5.99	3.19
1 1/4	1 1/4-11 1/2	6100-20	6120-20	6.33	2.73
1 1/2	1 1/2-11 1/2	6100-24	6120-24	6.55	3.52

6100 Series

Coupling with Hex Nut

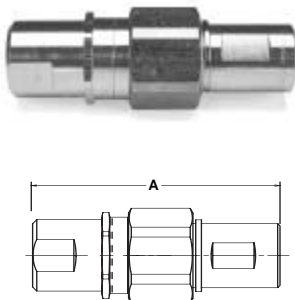

Body Size (in.)	Thread Size NPTF	Part No. With Flange	Part No. Without Flange	Overall Connected Length	Wt. (LB.) P/Piece
A					
3/4	1/2-14	6110-08	6130-08	5.20	1.89
3/4	3/4-14	6110-12	6130-12	5.20	1.83
1	1-11 1/2	6110-16	6130-16	5.99	2.93
1 1/4	1 1/4-11 1/2	6110-20	6130-20	6.33	4.12
1 1/2	1 1/2-11 1/2	6110-24	6130-24	6.55	5.95

Hydraulic Quick Couplings

Connect Under Pressure Couplings 6100 Series

Couplers

Wing Nut

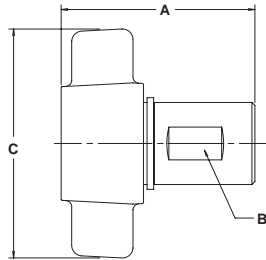

Body Size (in.)	Part No. Brass	Thread Size NPTF	Dimensions (in.)			Wt. (LB.) P/Piece
			Overall Length	Wrench Flats	Wing Nut	
			A	B	C	
3/4	6125-08	1/2-14	3.22	1.16	4.06	1.30
3/4	6125-12	3/4-14	3.22	1.16	4.06	1.26
1	6125-16	1-11 1/2	3.87	1.43	4.38	1.89
1 1/4	6125-20	1 1/4-11 1/2	4.16	1.78	5.20	2.84
1 1/2	6125-24	1 1/2-11 1/2	4.34	2.00	5.32	3.72

Hex Nut

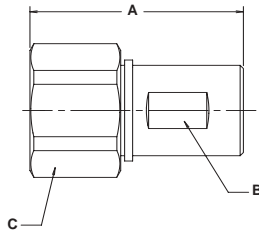

Body Size (in.)	Part No. Brass	Thread Size NPTF	Dimensions (in.)			Wt. (LB.) P/Piece
			Overall Length	Wrench Flats	Hex Size	
			A	B	C	
3/4	6135-08	1/2-14	3.22	1.16	1.75	1.07
3/4	6135-12	3/4-14	3.22	1.16	1.75	1.07
1	6135-16	1-11 1/2	3.87	1.43	2.13	1.63
1 1/4	6135-20	1 1/4-11 1/2	4.16	1.78	2.50	2.47
1 1/2	6135-24	1 1/2-11 1/2	4.34	2.00	2.75	3.15

Nipples

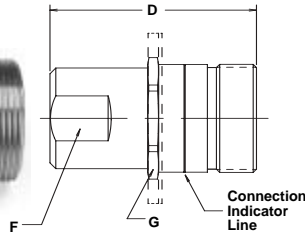

Body Size (in.)	Part No. Without Flange Brass	With Flange Brass	Thread Size NPTF	Dimensions (in.)			Wt. (LB.) P/Piece
				Overall Length	Hex Size	Wrench Flats	
				D	G	F	
3/4	6105-08	6115-08	1/2-14	3.11	1.62	1.18	0.82
3/4	6105-12	6115-12	3/4-14	3.11	1.62	1.18	0.76
1	6105-16	6115-16	1-11 1/2	3.55	1.88	1.56	1.30
1 1/4	6105-20	6115-20	1 1/4-11 1/2	3.71	2.13	1.88	1.65
1 1/2	6105-24	6115-24	1 1/2-11 1/2	4.12	2.50	2.18	2.61

Flanges

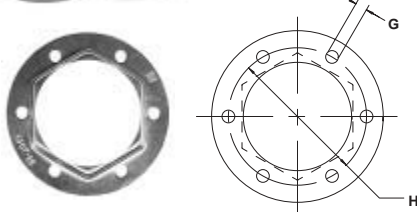

Body Size (in.)	Part No. Steel	Dimensions (in.)	
		Bolt Hole Diameter	Bolt Circle Diameter
		G	H
3/4	6107-08 (1 piece)	.208	2.125
1	6107-16 (1 piece)	.208	2.375
1 1/4	6107-20 (2 piece)	.208	2.625
1 1/2	6107-24 (2 piece)	.281	3.250



Applications

The 8200 Series brings to the industry a proven design for use on construction equipment, forestry equipment, agricultural machinery, oil tools, steel mill machinery, and other demanding hydraulic applications.

Note: Protective dust plugs and caps play a crucial role in the life of a quick coupling and no purchase of a hydraulic quick coupling is complete without the selection of an appropriate dust plug and cap. See pages noted in Table of Contents for dust plugs and caps for the Parker full line of hydraulic couplings.

Special Order Information

Standard seal material is Nitrile, other seal options are available. See Ordering Information at end of Section B and Fluid Compatibility Chart at end of this catalog for assistance in making seal selection.

Features

Parker 8200 Series couplings feature:

- Unique valve design permits connection while either or both the coupler and nipple are under pressure.
- Double acting sleeve for one handed push-to-connect operation when coupler is clamp or bulkhead mounted.
- Critical parts are hardened for durability.
- Dependable ball locking mechanism holds the mating halves together.
- Couplers and nipples are precision machined from solid bar stock.

Specifications

Body Size (in.)	1/2
Rated Pressure (PSI)	3000
Rated Flow (GPM)	12
Temperature Range (std seals)	-40° to +250°F

Performance

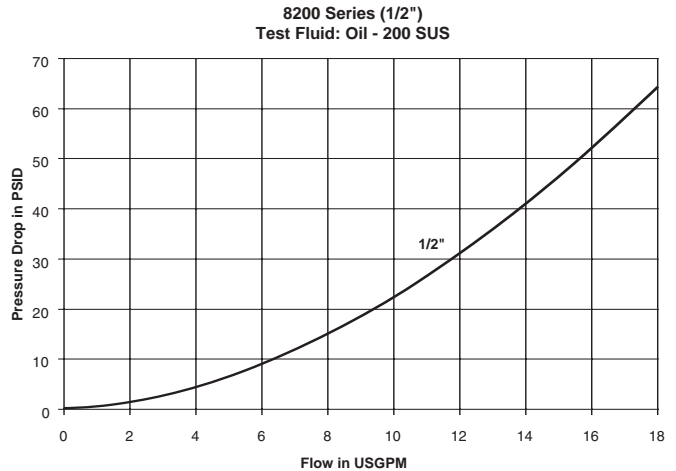

Couplers

Female Thread

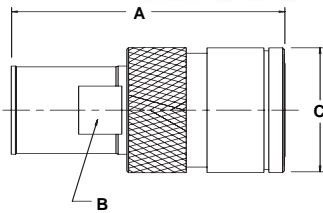

Body Size (in.)	Part No. Steel	Thread Size NPSF	Thread Size ORB	Dimensions (in.)			Wt. (LB.) P/Piece
				Overall Length	Wrench Flats	Largest Diameter	
				A	B	C	
1/2	8250-4	1/2-14	–	3.29	0.87	1.50	0.63
1/2	8250-15	–	3/4-16	3.29	0.87	1.50	0.63
1/2	8250-16	–	7/8-14	3.29	0.87	1.50	0.63

Nipples

Female Thread

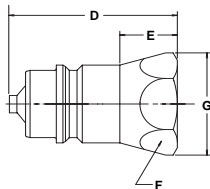

Body Size (in.)	Part No. Steel	Thread Size NPTF	Thread Size ORB	Dimensions (in.)				Wt. (LB.) P/Piece
				Overall Length	Exposed Length	Hex Size	Largest Diameter	
				D	E	F	G	
1/2	8010-4	1/2-14	–	1.95	1.09	1.06	1.23	0.20
1/2	8010-4P*	1/2-14	–	1.95	1.09	1.06	1.23	0.20
1/2	8010-15	–	3/4-16	2.06	1.20	1.06	1.23	0.20
1/2	8010-15P*	–	3/4-16	2.06	1.20	1.06	1.23	0.20
1/2	8010-16	–	7/8-14	2.05	1.18	1.06	1.23	0.25
1/2	8010-16P*	–	7/8-14	2.05	1.18	1.06	1.23	0.25

* Poppet design

Replacement Parts - 8200 Series

Body Size (in.)	Part Number	Description	Material
1/2	50005-211-0202	Q-Ring	Nitrile

Hydraulic Quick Couplings

Connect Under Pressure Couplings 9200 Series



Applications

The Parker 9200 lever coupling is designed with a lever-operated cam that opens and closes the valves in both coupling halves, positively locking them into place. This allows the couplings to be easily connected and disconnected while under pressure. The 9200 couplings can functionally replace a Double Shut-Off quick coupling and two high pressure ball valves. By simply turning the lever to the "closed" position the hydraulic lines on a piece of machinery or mobile equipment may be disconnected either for maintenance or equipment changeovers.

Note: Protective dust plugs and caps play a crucial role in the life of a quick coupling and no purchase of a hydraulic quick coupling is complete without the selection of an appropriate dust plug and cap. See pages noted in Table of Contents for dust plugs and caps for the Parker full line of hydraulic couplings.

Performance

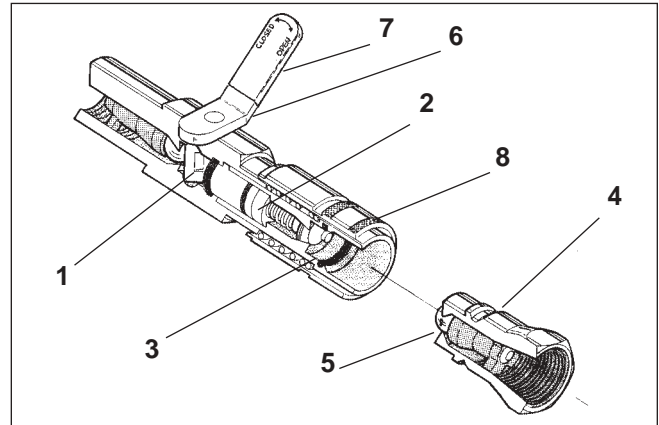
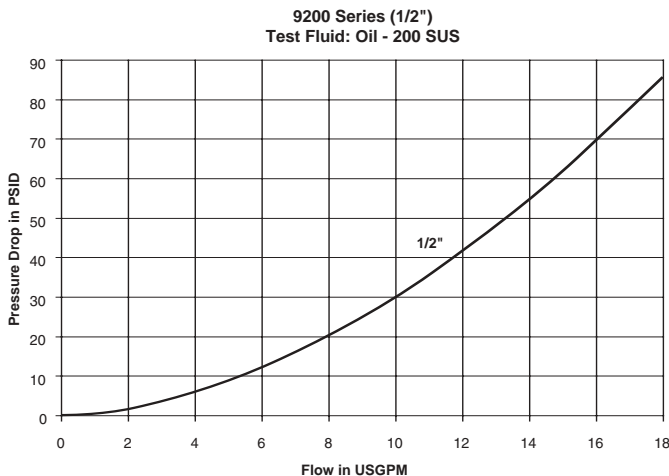

Features

1. The lever operates a cam that mechanically locks both valves into either the "open" or "closed" position.
"Closed," the flow is shut off at the coupler, allowing easy zero-pressure connect and disconnect.
"Open," the valves are locked in the open position in both coupler and nipple. In this position the valves are unaffected by hydraulic surges.
2. Parker design eliminates back flow-checking. The positive lock of the cam prevents hydraulic surges from forcing the valve closed, which avoids flow checking and disrupting equipment performance.
3. Valves close automatically if coupling is accidentally disconnected.
4. The 8010 Series nipples used with the 9200 coupler is an industry standard that meets ISO, ASAE, and SAE requirements.
5. Rugged, reliable ball valve and induction hardened locking ball groove prevent Brinelling and prolong coupling life.
6. Turning the lever without the nipple in place will NOT result in oil flow.
7. The Lever Coupler is covered by patent numbers: #3680591 and #4009729.
8. New easy action sleeve aids connect and disconnect.

Specifications

Body Size (in.)	1/2
Rated Pressure (PSI)	3000
Rated Flow (GPM)	12
Temperature Range (std seals)	-40° to +250° F

Couplers

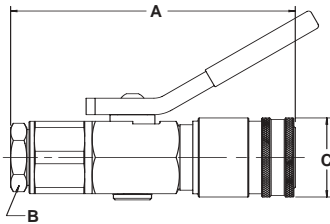

Body Size (in.)	Part No. Steel	Thread Size NPTF	Dimensions (in.)		Overall Length	Wrench Flats	Largest Diameter	Wt. (LB.) P/Piece	
			ORB						
					A	B	C		
1/2	9250-4-320	1/2-14	–		5.37	1.13	1.50	2.02	
1/2	9250-6-320	–	9/16-18		5.37	1.13	1.50	2.04	
1/2	9250-15-320	–	3/4-16		5.37	1.13	1.50	2.06	
1/2	9250-16-320	–	7/8-14		5.37	1.13	1.50	1.98	
*1/2	9250-334	–	9/16-18		5.37	1.13	1.50	2.15	

* Mates with the 1/4" 60 Series Nipples.

Nipples

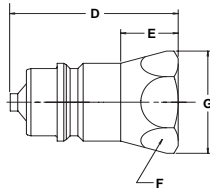

Body Size (in.)	Part No. Steel	Thread Size NPTF	Thread Size ORB	Overall Length	Dimensions (in.)				Wt. (LB.) P/Piece	
					Exposed Length	Hex Size	Largest Diameter			
					D	E	F	G		
1/2	8010-4	1/2-14	–	1.95	1.09	1.06	1.23	0.20		
1/2	8010-4P*	1/2-14	–	1.95	1.09	1.06	1.23	0.20		
1/2	8010-15	–	3/4-16	2.06	1.20	1.06	1.23	0.20		
1/2	8010-15P*	–	3/4-16	2.06	1.20	1.06	1.23	0.20		
1/2	8010-16	–	7/8-14	2.05	1.18	1.06	1.23	0.25		
1/2	8010-16P*	–	7/8-14	2.05	1.18	1.06	1.23	0.25		

* Poppet design

Replacement Parts

9200 Series

Body Size (in.)	1/2
O-Rings - Nitrile	50001-211-0260



Features

The Parker 5000 Series coupling features:

- Two-piece coupler body that permits operation while one or both halves are under pressure as well as when there is no pressure in either half.
- Connect under pressure by unscrewing the valve body until two or three threads are visible.
- Nipple can be inserted and locked into the coupler without opening either valve. (Use a wrench to thread the valve body back into the coupler, the valves are opened against internal pressure. If internal pressure makes manual disconnect difficult, unscrewing the valve body from the coupler will permit the valves to close, thereby relieving internal pressure and allowing manual operation of the ball-locking sleeve.)

Applications

The Parker 5000 Series is an economical coupling that is a threaded union and can be connected under pressure with tools. For applications that require a coupling to be connected under-pressure and where tools can be used to make the connection, the 5000 Series coupling should be considered.

Note: Protective dust plugs and caps play a crucial role in the life of a quick coupling and no purchase of a hydraulic quick coupling is complete without the selection of an appropriate dust plug and cap. See pages noted in Table of Contents for dust plugs and caps for the Parker full line of hydraulic couplings.

Performance

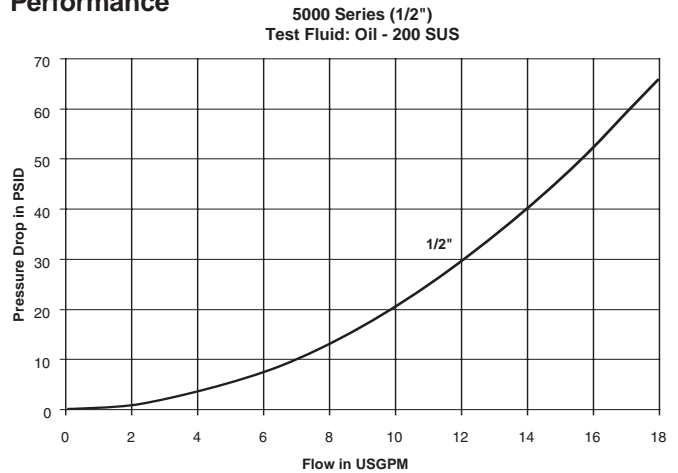

Specifications

Body Size (in.)	1/2
Rated Pressure (PSI)	2500
Rated Flow (GPM)	12
Temperature Range (std seals)	-40° to +250°F

Hydraulic Quick Couplings

Connect Under Pressure Couplings 5000 Series

Coupler



Body Size (in.)	Part No. Steel	Thread Size NPTF	Overall Length	Dimensions (in.)				Largest Diameter	Wt. (LB.) P/Piece
				Length	Wrench Flats	Wrench Flats			
			A	B	C	D	E		
1/2	5050-4	1/2-14	2.88	2.32	1.06	1.25	1.52	2.58	

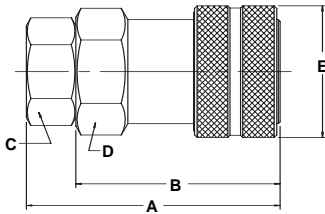

Nipple



Body Size (in.)	Part No. Steel	Thread Size NPTF	Dimensions (in.)		Overall Length	Exposed Length	Hex Size	Largest Diameter	Wt. (LB.) P/Piece
			ORB						
				D	E	F	G		
1/2	8010-4	1/2-14	—	1.95	1.09	1.06	1.23	0.20	
1/2	8010-15	—	3/4-16	2.06	1.20	1.06	1.23	0.20	
1/2	8010-16	—	7/8-14	2.05	1.18	1.06	1.23	0.20	

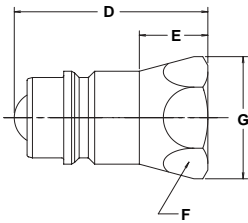

Replacement Parts 5000 Series

Body Size (in.)	1/2
O-Rings - Nitrile	50001-211-0260

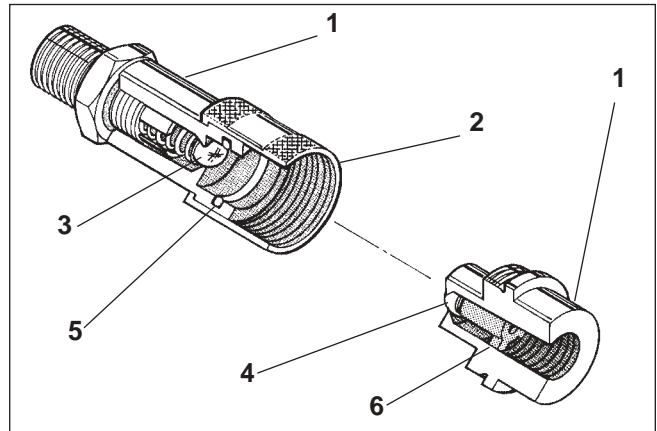

Applications

Parker 3000 Series couplings with their threaded union locking system and precision ball-type check valves, are designed for extreme high pressure applications such as found on portable hydraulic rams. See pages noted in Table of Contents for dust plugs and caps for the Parker full line of hydraulic couplings.

Note: Protective dust plugs and caps play a crucial role in the life of a quick coupling and no purchase of a hydraulic quick coupling is complete without the selection of an appropriate dust plug and cap. See pages noted in Table of Contents for hydraulic couplings dust plugs and caps for the full line of hydraulic couplings.

Features

1. Machined from solid steel barstock for durability.
2. The 3000 Series employs a threaded sleeve locking mechanism, mates with matching male threads on the nipple. The two halves must be manually threaded together for connection.
3. Hard, chrome alloy balls are used for valving. They are spring loaded for positive seating of the valve.
4. The valve provides a metal-to-metal seal between the ball and a coined seat.
5. The interface seal is polyurethane which resists high pressure extrusion.
6. A threaded valve retainer provides a valve stop that assures positive valve alignment.

Specifications

Body Size (in.)	1/4	3/8
Rated Pressure (PSI) Static	10,000	10,000
Rated Flow (GPM)	3	6
Temperature Range (std seals)	-40° to +180°F	

Performance

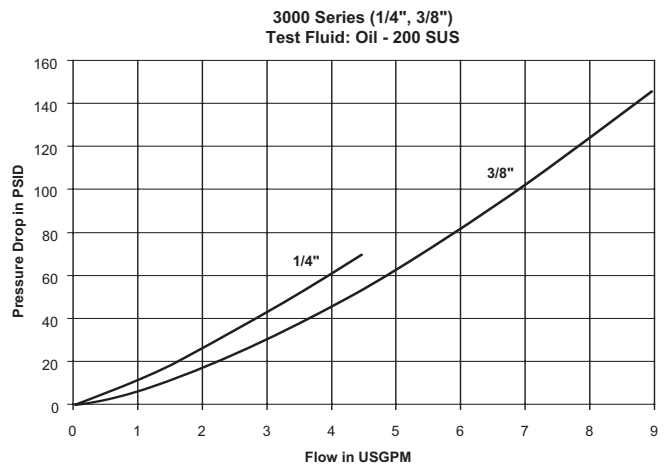

Couplers

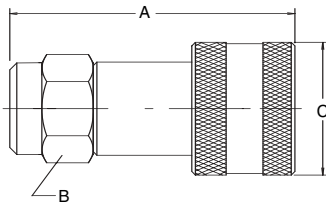
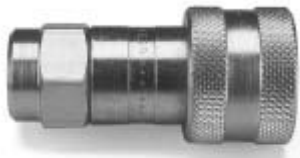

Body Size (in.)	Part No.	Thread Size NPTF	Dimensions (in.)			Wt. (LB.) P/Piece
			Overall Length	Wrench Flats	Largest Diameter	
			A	B	C	
1/4	3050-2	1/4-18 (Male)	2.38	0.81	1.13	0.25
3/8	3050-3	3/8-18 (Male)	2.88	1.00	1.38	0.49
3/8	3050-3-231	3/8-18 (Female)	2.82	1.00	1.38	0.49

Nipples

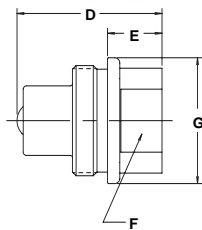

Body Size (in.)	Part No. Steel	Thread Size NPTF	Overall Length	Dimensions (in.)			Largest Diameter	Wt. (LB.) P/Piece
				Expose Length	Hex Size			
			D	E	F	G		
1/4	3010-2	1/4-18 (Female)	1.29	0.48	0.75	1.13	0.14	
3/8	3010-3	3/8-18(Female)	1.58	0.50	0.94	1.25	0.23	
3/8	3010-3-230	3/8-18 (Male)	2.31	1.23	1.00	1.25	0.30	



Specifications

Body Size (in.)	3/8
Rated Pressure (PSI)	10,000
Rated Flow (GPM)	6
Temperature Range (std seals)	-15° to +400°F

Performance

TC Series (3/8")
Test Fluid: Oil - 200 SUS

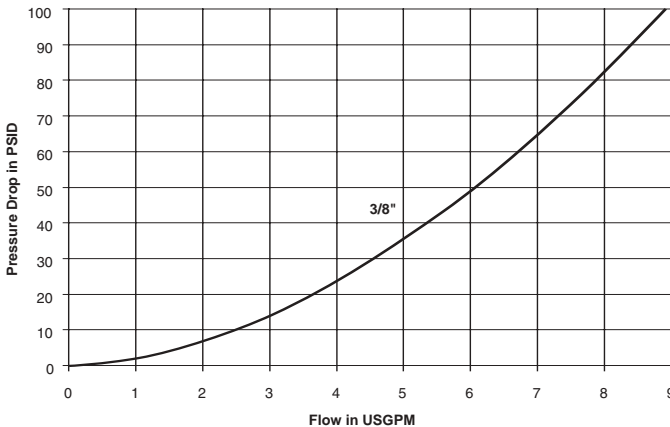

Features

- Positive valve stop. The perch maintains valve alignment and provides metal to metal valve stop to insure that the valves open full—every time.
- Precision machined valves with elastomeric seals provide for positive shut-off upon disconnection.
- Hardened nipples and sleeves and solid barstock construction make for a quality coupling with maximum resistance to damage from hydraulic and mechanical shock.
- Durable ball-locking mechanism assures reliable connection every time. A large number of locking balls distributes the work load evenly while providing alignment and swiveling action to reduce hose torque and prolong hose life. CAUTION: These products are not to be used as swivels, rotation under pressure will result in excessive and premature wear.
- Female pipe (NPSF) standard.
- The standard Fluorocarbon seal is designed to withstand extremely high pressures and provide reliable sealing. PTFE back-up ring provides support for the seal in high pressure applications.
- Sleeve locking mechanism prevents accidental disconnection when the coupling is dragged along the ground.
- Steel construction, zinc plated with yellow chromate finish for corrosion resistance.

Applications

Parker TC series couplings are found in the construction, railway maintenance and house moving industries. Used on hydraulic jacking equipment, these couplers eliminate costly down time caused by improperly connected threaded types. For use where high pressure capability is required coupled with positive coupling action. Considerably faster to use than threaded types.

Note: Protective dust plugs and caps play a crucial role in the life of a quick coupling and no purchase of a hydraulic quick coupling is complete without the selection of an appropriate dust plug and cap. See pages noted in Table of Contents for dust plugs and caps for the Parker full line of hydraulic couplings.

Coupler

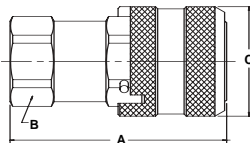

Body Size (in.)	Part No.	Fitting Thread Size	Dimensions (in.)			Wt. (LB.) P/Piece
			Overall Length	Hex Size	Largest Diameter	
			A	B	C	
3/8	TC-371	3/8-18 NPSF	2.48	0.94	1.25	0.43

Nipple

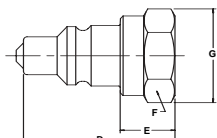

Body Size (in.)	Part No.	Fitting Thread Size	Dimensions (in.)				Wt. (LB.) P/Piece
			Overall Length	Exposed Length	Hex Size	Largest Diameter	
			D	E	F	G	
3/8	TC-372	3/8-18 NPSF	1.82	0.66	0.94	1.08	0.14

NPSF – National Pipe Straight Fuel



Applications

The 1141 Series is a general purpose coupling for high pressure connect-under-pressure applications.

Features

- 303 Stainless steel body.
- Brass locking sleeve
- Polyurethane seals to resist extrusion and abrasion.
- Self locking threads help prevent coupling from accidentally disconnecting.
- Visual makeup – when fully coupled the edge of the sleeve will be flush with the end of the male thread – giving a visual check for complete coupling.
- Small diameter mating seal helps keep separation forces to a minimum, allowing for easier connect and disconnect at pressures up to 5,000 PSI.
- 10,000 PSI working pressure, 17,000 PSI intermittent pressure.
- Dust caps and plugs included.

Specifications

Body Size (in.)	1/4
Rated Pressure (PSI)	10,000
Rated Connect-Under-Pressure Capability (PSI)	5000
Rated Flow (GPM)	3
Temperature Range (Polyurethane seals)	-30° to +180°F
Vacuum test	20 in/Hg
Torque to connect at 1000 PSI	47 in/lbs.

Coupler

Body Size (in.)	Part No.	Thread Size NPTF	Dimensions (in.)		Wt. (LB.) P/Piece
			A	B	
1/4	1141-62	1/4-18	2.75	1.00	0.40

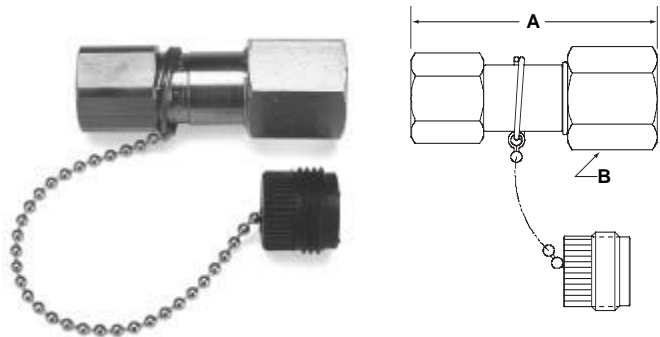

Nipple

Body Size (in.)	Part No.	Thread Size NPTF	Dimensions (in.)		Wt. (LB.) P/Piece
			C	D	
1/4	1141-63	1/4-18	2.00	.88	0.26

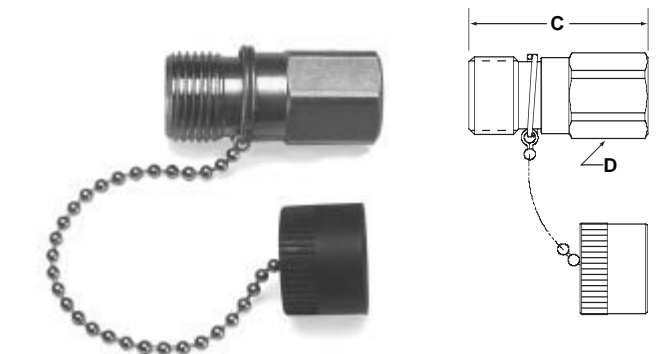



Selection Guidelines

Moldmate couplings are designed for a maximum working pressure of 200 PSI. Most thermoplastic and thermoset heat transfer systems have pumps which provide relatively high flow rates at relatively low pressures. Water and water glycol systems usually have capacities ranging from 10 to 40 gpm, with most from 10 to 15 gpm. Normal medial opening pressures are 20 to 60 PSI for these systems. Heat transfer systems using oil generally operate from 10 to 30 PSI. However, their flow rates are usually much higher, requiring the total volume of oil to be circulated at least once per minute.

The number of hose connections in a single mold system results in a cumulative pressure drop. Please note the Pressure Drop vs. Flow Rate chart provided, to select the appropriate size.

Temperature is another important consideration. Parker moldmate couplings with their standard Silicone seal have a temperature capability of -90° to +400°F. Rapid deterioration of the seal and leakage may result if used beyond these limits.

External conditions of temperature, corrosive atmospheres, and other abnormalities may affect coupling performance and must be considered when selection is made. Consult factory with questions.

Applications

Parker moldmate couplings are specifically designed for connecting coolant lines to molds and dies, on injection molding machinery in the plastics and die casting industries. Moldmate couplings significantly reduce machine downtime by providing fast and easy connection of coolant lines during mold changes. Their short nipples can be recessed below the surface of the mold for more efficient storage of molds. Moldmate couplers are available with or without valves in the female half. Non-valved couplers provide maximum flow for efficient cooling. Valved couplers shut off when disconnected.

Special Order Information

Standard seal material is Silicone and is compatible with water and water glycol fluids commonly used in heat transfer systems. Fluorocarbon seals are available for use only with oil-based media and not with water glycol. To specify a Fluorocarbon seal, add the suffix "Y" to the standard moldmate part number, thus: PC206Y.

Specifications

Body Size (in.)	1/4	3/8	1/2
Rated Pressure (PSI)	200	200	200
Rated Flow (GPM)	3	6	12

Material	Temperature Range
Standard Silicone seal	-90° to +400°F
*Optional Fluorocarbon seal	-15° to +400°F

* For use with oil based media only

Performance

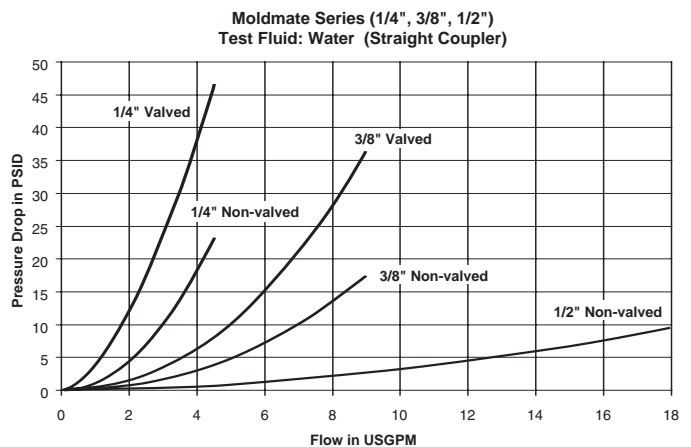

Hydraulic Quick Couplings

Mold Coolant Line Couplings

Moldmate Series

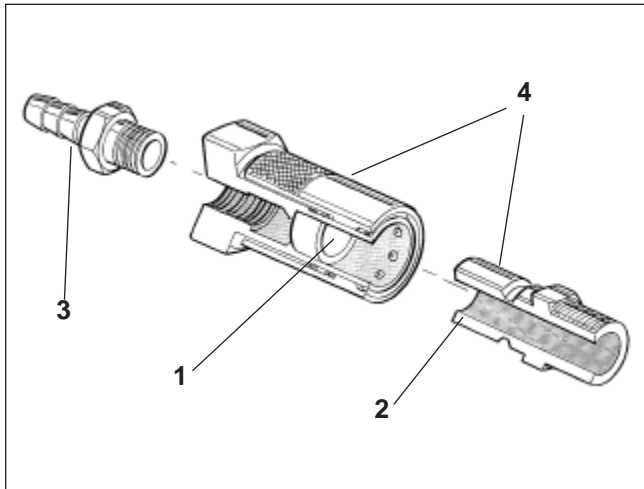

Features

1. Available with or without valves in the coupler. Non-valved couplers have minimum flow resistance for maximum cooling. Valved couplers shut off automatically upon disconnect. Valved couplers can be used with either valved or non-valved nipples. A valved nipple, however, must be used with a valved coupler.
2. Nipples are designed to be recessed below mold surfaces to provide more efficient storage of molds and prevent damage to the nipple.
3. Widest choice of end fittings available, including straight, 45° or 90° with standard hose barb or Push-Lok bars for easy installation.
4. Couplers and nipples are made of corrosion resistant brass, and valved couplers or valved nipple have a Fluorocarbon O-ring on poppet and Silicone interface seal as standard for use with water glycol type fluids commonly used in heat transfer systems.
5. Silver colored sleeve designates valved coupler.

Couplers

Straight

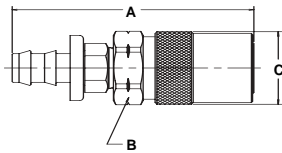

45 Degree

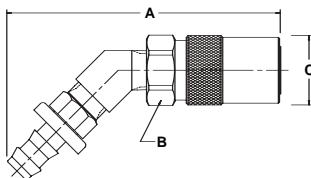

Body Size (in.)	Part No. Brass Non-valved	Wt. (LB.) P/Piece	Part No. Brass Valved	Wt. (LB.) P/Piece	Hose I.d.	Dimensions (in.)					
						Overall Length	Largest Diameter		Overall Length	Hex Largest Diameter	
							A	B		C	A
1/4	PC204	0.10	PC204AV	0.10	1/4	1.87	0.63		2.67	0.56	0.71
1/4	PC204-BP*	0.10	PC204AV-BP	0.10	1/4	1.89	0.63		2.52	0.56	0.71
1/4	PC205	0.09	PC205AV	0.10	5/16	1.87	0.63		2.67	0.56	0.71
1/4	PC206	0.09	PC206AV	0.10	3/8	1.87	0.63		2.67	0.56	0.71
1/4	PC206-BP*	0.11	PC206AV-BP	0.13	3/8	2.04	0.63		2.70	0.56	0.71
3/8	PC306	0.24	PC306V	0.27	3/8	3.01	0.96		3.17	0.88	0.96
3/8	PC306-BP*	0.26	PC306V-BP	0.29	3/8	3.15	0.96		3.31	0.88	0.96
3/8	PC308	0.25	PC308V	0.28	1/2	3.15	0.96		3.17	0.88	0.96
3/8	PC308-BP*	0.25	PC308V-BP	0.03	1/2	3.27	0.96		3.43	0.88	0.96
1/2	PC504	0.46	NA	-	1/2	3.55	1.30		-	-	-
1/2	PC504-BP*	0.50	NA	-	1/2	3.68	1.21		-	-	-
1/2	PC506	0.48	NA	-	3/4	3.80	1.21		-	-	-
1/2	PC506-BP*	0.52	NA	-	3/4	3.80	1.21		-	-	-

NA = Not Available

Body Size (in.)	Part No. Brass Non-valved	Wt. (LB.) P/Piece	Part No. Brass Valved	Wt. (LB.) P/Piece	Hose I.D.	Dimensions (in.)						
						Overall Length	Hex Size	Largest Diameter		Overall Length	Hex Size	Largest Diameter
								A	B			
1/4	PC224	0.13	PC224AV	0.13	1/4	2.67	0.56	0.71	2.87	0.56	0.71	
1/4	PC224-BP*	0.13	PC224AV-BP	0.14	1/4	2.57	0.56	0.71	2.77	0.56	0.71	
1/4	PC225	0.13	PC225AV	0.13	5/16	2.69	0.56	0.71	2.89	0.56	0.71	
1/4	PC226	0.13	PC226AV	0.14	3/8	2.71	0.56	0.71	2.91	0.56	0.71	
1/4	PC226-BP*	0.26	PC226AV-BP	0.17	3/8	2.74	0.56	0.71	2.94	0.56	0.71	
3/8	PC326	0.36	PC326V	0.36	3/8	3.65	0.88	0.96	3.65	0.88	0.96	
3/8	PC326-BP*	0.34	PC326V-BP	0.36	3/8	3.75	0.88	0.96	3.75	0.88	0.96	
3/8	PC328	0.36	PC328V	0.36	1/2	3.69	0.88	0.96	3.69	0.88	0.96	
3/8	PC328-BP*	0.34	PC328V-BP	0.40	1/2	3.88	0.88	0.96	3.88	0.88	0.96	
1/2	PC524	0.74	NA	-	1/2	4.18	1.12	1.21	-	-	-	
1/2	PC524-BP*	0.78	NA	-	1/2	4.28	1.12	1.21	-	-	-	
1/2	PC526	0.76	NA	-	3/4	4.56	1.12	1.21	-	-	-	
1/2	PC526-BP*	0.80	NA	-	3/4	4.56	1.12	1.21	-	-	-	

* Suffix BP in part number denotes Push-Lok hose barb. Without suffix denotes standard hose barb.

Push-Lok hose bars are designed for use with Parker Push-Lok hose and do not require clamps.

Valved Couplers can be used with either non-valved or valved nipples.



Hydraulic Quick Couplings

Mold Coolant Line Couplings Moldmate Series

90 Degree

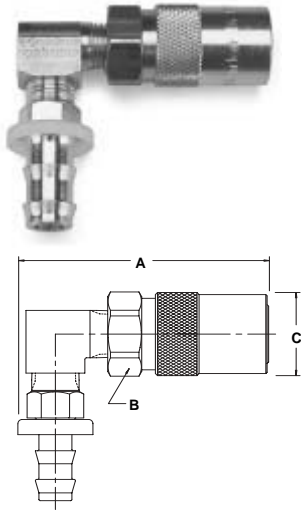

Body Size (in.)	Part No. Brass Non-valved	Wt. (LB.) P/Piece	Part No. Brass Valved	Wt. (LB.) P/Piece	Hose I.D.	Dimension (in.)			Dimensions (in.)		
						Overall Length	Hex Size	Largest Diameter	Overall Length	Hex Size	Largest Diameter
						Non-valved			Valved		
						A	B	C	A	B	C
1/4	PC214	0.13	PC214AV	0.14	1/4	1.78	0.56	0.71	1.98	0.56	0.71
1/4	PC214-BP*	0.14	PC214AV-BP	0.14	1/4	1.78	0.56	0.71	1.98	0.56	0.71
1/4	PC215	0.13	PC215AV	0.14	5/16	1.78	0.56	0.71	1.98	0.56	0.71
1/4	PC216	0.14	PC216AV	0.15	3/8	1.78	0.56	0.71	1.98	0.56	0.71
1/4	PC216-BP*	0.16	PC216AV-BP	0.17	3/8	1.80	0.56	0.71	2.00	0.56	0.71
3/8	PC316	0.31	PC316V	0.31	3/8	2.78	0.88	0.96	2.78	0.88	0.96
3/8	PC316-BP*	0.37	PC316V-BP	0.37	3/8	2.78	0.88	0.96	2.78	0.88	0.96
3/8	PC318	0.33	PC318V	0.35	1/2	2.78	0.88	0.96	2.78	0.88	0.96
3/8	PC318-BP*	0.37	PC318V-BP	0.39	1/2	2.80	0.88	0.96	2.80	0.88	0.96
1/2	PC514	0.79	NA	-	1/2	3.50	1.12	1.21	-	-	-
1/2	PC514-BP*	0.83	NA	-	1/2	3.50	1.12	1.21	-	-	-
1/2	PC516	0.80	NA	-	3/4	3.50	1.12	1.21	-	-	-
1/2	PC516-BP*	0.84	NA	-	3/4	3.50	1.12	1.21	-	-	-

* Suffix BP in part number denotes Push-Lok hose barb. Without suffix denotes standard hose barb. Push-Lok hose barbs are designed for use with Parker Push-Lok hose and do not require clamps. Valved Couplers can be used with either non-valved or valved nipples.

Sub Assemblies and Individual Replacement Parts

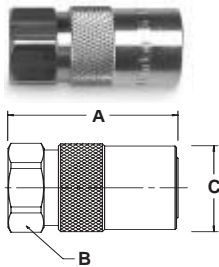

Non-valved Sub-assembly (Brass Sleeve)

Body Size (in.)	Part No. Brass For No-valving	Wt. (LB.) P/Piece	Thread Size NPTF	Dimensions (in.)		
				Overall Length	Hex Size	Largest Diameter
				A	B	C
1/4	P208-01A	0.07	1/8-27	1.15	0.56	0.71
3/8	P308-01A	0.21	1/4-18	1.84	0.88	0.96
3/8	P308-01A-HF	0.20	3/8-18	1.84	0.88	0.96
1/2	PC500	0.34	1/2-14	2.02	1.12	1.21

Valved* Sub-assembly (Silver Colored Sleeve)

Body Size (in.)	Part No. Brass For Valving	Wt. (LB.) P/Piece	Thread Size NPTF	Dimensions (in.)		
				Overall Length	Hex Size	Largest Diameter
				A	B	C
1/4	P201-01A	0.07	1/8-27	1.35	0.56	0.71
3/8	P301-01A	0.21	1/4-18	1.84	0.88	0.96

*Bodies are designed for use with valves retained by a male pipe fitting (i.e. hose barb). Order valves and valve springs separately.



Valves (for Valved Sub-assembly)

Body Size (in.)	Part No.	Material
1/4	3613001	Brass
3/8	P300-11S	Brass

Valve Springs (for Valved Sub-assembly)

Body Size (in.)	Part No.	Material
1/4	7820123	Stainless
3/8	P300-6	Stainless

Replacement Seals (for both Valved and Non-valved)

Seal Material	Body Size (in.) 1/4	Body Size (in.) 3/8	Body Size (in.) 1/2
* Silicone	P200-9A	P300-9A	P500-9A
* Fluorocarbon	P200-9AY	P300-9AY	—

* Please note: Bulk seals are considered to be non-returnable.

Assembly Instruction Sheet (for all sizes & configurations)

Order Part Number 9090065



Hydraulic Quick Couplings

Mold Coolant Line Couplings Moldmate Series

Nipples

Female Pipe Thread

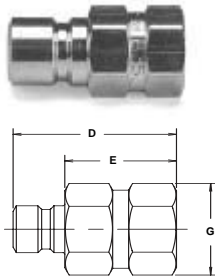

Body Size (in.)	Part No. Brass	Wt. (LB.) P/Piece Brass	Part No. Steel	Wt. (LB.) P/Piece Steel	Thread Size NPTF	Dimensions (in.)			
						Overall Length	**Exposed Length	Hex Size	Largest Diameter
						D	E	F	G
1/4	BPN251F	0.02	PN251F	0.02	1/8-27	0.97	0.58	0.50	0.58
1/4	BPN252F	0.05	PN252F	0.04	1/4-18	1.28	0.89	0.63	0.72
1/4	BPN253F	0.08	PN253F	0.08	3/8-18	1.41	1.02	0.75	0.87
3/8	BPN352F	0.05	PN352F	0.05	1/4-18	1.48	0.88	0.63	0.72
3/8	BPN353F	0.07	PN353F	0.06	3/8-18	1.58	0.98	0.75	0.87

Male Pipe Thread

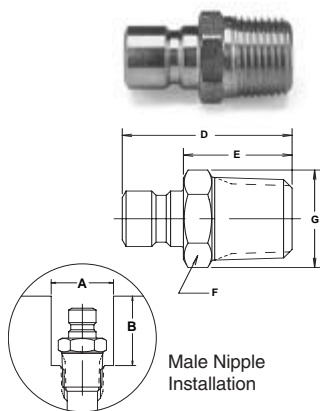

Body Size (in.)	Part No. Brass	Wt. (LB.) P/Piece Brass	Part No. Steel	Wt. (LB.) P/Piece Steel	Thread Size NPTF	Dimensions (in.)				Installation Recess	
						Overall Length	**Exposed Length	Hex Size	Largest Dia.	Dia.	Depth
						D	E	F	G	A	B
1/4	PN250	0.02	-	-	1/16-27	0.94	0.54	0.44	0.51	0.69	0.69
1/4	PN251	0.02	PN251S	0.02	1/8-27	0.94	0.54	0.44	0.51	0.69	0.69
1/4	PN252	0.03	PN252S	0.03	1/4-18	1.13	0.74	0.56	0.67	0.84	0.94
1/4	PN253	0.05	PN253S	0.05	3/8-18	1.19	0.79	0.69	0.79	1.00	0.94
3/8	PN352	0.04	PN352S	0.04	1/4-18	1.34	0.74	0.56	0.65	1.00	1.09
3/8	PN353	0.06	PN353S	0.06	3/8-18	1.38	0.78	0.69	0.79	1.00	1.13
3/8	PN354	0.12	NA	-	1/2-14	1.59	0.99	0.88	1.01	1.19	1.25
1/2	PN553	0.12	NA	-	3/8-18	1.53	0.77	0.88	1.01	1.25	1.34
1/2	PN554	0.11	NA	-	1/2-14	1.70	0.94	0.88	1.01	1.25	1.50
1/2	PN556	0.16	NA	-	3/4-14	1.75	0.99	1.06	1.23	1.50	1.56

Valved Nipple

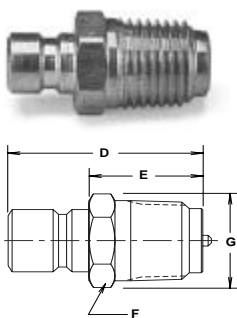

Body Size (in.)	Part No. Brass	Thread Size NPTF	Overall Length	**Exposed Length	Dimensions (in.)			Installation Recess Dia.	Depth	Wt. (LB.) P/Piece
					Hex Size	Largest Dia.	F			
			D	E	F	G	A	B		
1/4	BPV252*	1/4-18	1.21	0.82	.56	0.67	0.84	0.94	0.03	
3/8	BPV353*	3/8-18	1.48	0.88	.69	0.79	1.00	1.23	0.07	

*Valved Nipple must be used with Valved Coupler.

**This dimension represents the portion of the nipple that is exposed when inserted into a moldmate coupler.

Moldmate Extension Nipples

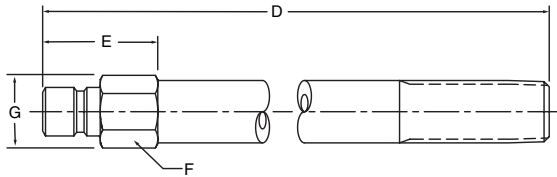

Body Size (in.)	Part No. Brass	Thread Size NPTF	Overall Length	Dimensions (in.)			Wt. (LB.) P/Piece
				D	E	F	
1/4	PN250-25	1/16-27	2.50	.69	3/8	0.43	0.04
1/4	PN250-40	1/16-27	4.00	.81	3/8	0.43	0.06
1/4	PN250-55	1/16-27	5.50	.81	3/8	0.43	0.09
1/4	PN251-25	1/8-27	2.50	.69	7/16	0.51	0.06
1/4	PN251-40	1/8-27	4.00	1.00	7/16	0.51	0.10
1/4	PN251-55	1/8-27	5.50	1.00	7/16	0.51	0.13
1/4	PN251-70	1/8-27	7.00	1.00	7/16	0.51	0.17
1/4	PN251-85	1/8-27	8.50	1.00	7/16	0.51	0.21
1/4	PN252-25	1/4-18	2.50	.88	9/16	0.65	0.09
1/4	PN252-40	1/4-18	4.00	1.25	9/16	0.65	0.15
1/4	PN252-55	1/4-18	5.50	1.25	9/16	0.65	0.22
1/4	PN252-70	1/4-18	7.00	1.25	9/16	0.65	0.27
1/4	PN252-85	1/4-18	8.50	1.25	9/16	0.65	0.33
3/8	PN351-25	1/8-27	2.50	.88	9/16	0.65	0.07
3/8	PN351-40	1/8-27	4.00	1.00	9/16	0.65	0.11
3/8	PN351-55	1/8-27	5.50	1.00	9/16	0.65	0.15
3/8	PN351-70	1/8-27	7.00	1.00	9/16	0.65	0.18
3/8	PN351-85	1/8-27	8.50	1.00	9/16	0.65	0.22
3/8	PN352-25	1/4-18	2.50	.88	9/16	0.65	0.09
3/8	PN352-40	1/4-18	4.00	1.25	9/16	0.65	0.15
3/8	PN352-55	1/4-18	5.50	1.25	9/16	0.65	0.21
3/8	PN352-70	1/4-18	7.00	1.25	9/16	0.65	0.27
3/8	PN352-85	1/4-18	8.50	1.25	9/16	0.65	0.33
3/8	PN353-25	3/8-18	2.50	1.00	11/16	0.79	0.12
3/8	PN353-40	3/8-18	4.00	1.25	11/16	0.79	0.20
3/8	PN353-55	3/8-18	5.50	1.25	11/16	0.79	0.28
3/8	PN353-70	3/8-18	7.00	1.25	11/16	0.79	0.37
3/8	PN353-85	3/8-18	8.50	1.25	11/16	0.79	0.45

B Hydraulics



Applications

The Parker ST Series are non-valved couplings for applications where maximum flow is required. Their smooth, open bore offers the lowest pressure drop of any quick coupling design and is ideal for applications such as high-pressure water and steam washers, carpet cleaners and mold coolant lines and many other non-valved applications.

Specifications

Body Size (in.)	1/8	1/4	3/8	1/2	3/4	1	1 1/4	1 1/2
Rated Pressure (PSI)								
Brass Cplr/Npl	2500	5200	2700	2200	1700	1200	1700	1400
Brass Cplr/Steel Npl	2600	5500	3500	2700	2700	2000	-	-
SS Cplr/Npl	4200	6700	5500	3000	3000	1700	-	-
Rated Flow	3	6	12	12	28	50	76	100
Temperature Range (std seals)	-40° to +250°F							

Performance

ST Series (1/8", 1/4", 3/8", 1/2")
Test Fluid: Oil - 150 SUS

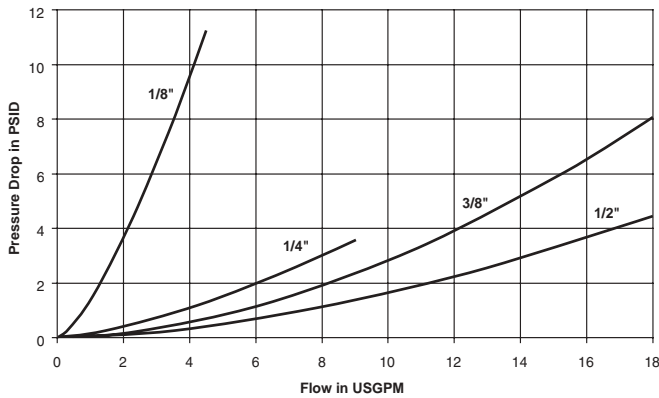

ST Series (3/4", 1", 1-1/4")
Test Fluid: Oil - 150 SUS

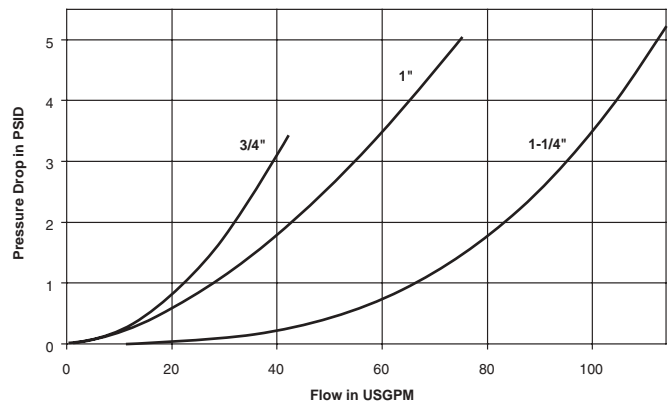

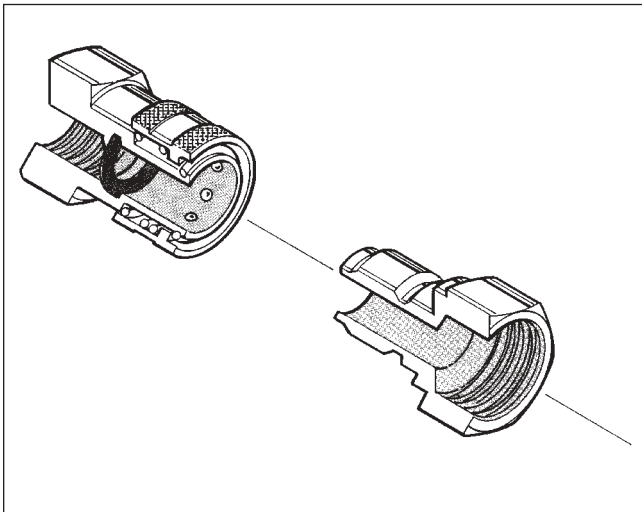

Features

- The smooth, open bore with no valving in either half offers minimal pressure drop and allows easy cleaning in applications where the same lines are used for more than one media.
- ST couplers and nipples are machined from solid barstock, providing a quality coupling that is durable. ST couplers are available in brass and 303 stainless steel as standard product materials.
- ST nipples are available in 303 stainless steel, brass and zinc-plated steel. The ball locking grooves of the steel ST nipples are case hardened for resistance to brinelling where high cycle rates and pressure surges are encountered.
- The ST is an "Interchange" coupling since it dimensionally and functionally interchanges with similar couplings made by other manufacturers.

Special Order Information

All sizes of ST Series can be furnished with locking sleeves. Place suffix letters "SL" (Sleeve-Lok) after regular catalog numbers. Example: SST-4MSL. Standard seal material is Nitrile. Ethylene Propylene, Fluorocarbon, or Neoprene seals are available upon request. See Fluid Compatibility Chart for recommendations.

Couplers

Female Pipe Thread

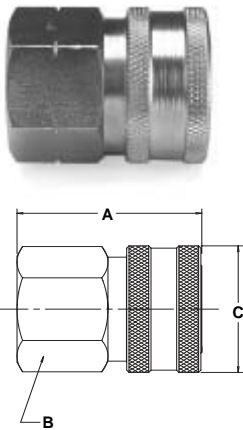

Body Size (in.)	Part No.		Part No.		Thread Size NPTF	Dimensions (in.)		
	Brass	Wt. (LB.) P/Piece	Type 303 Stainless	Wt. (LB.) P/Piece		Overall Length	Wrench Flats	Largest Diameter
						A	B	C
1/8	BST-1	0.06	SST-1	0.05	1/8-27	1.06	0.56	0.69
1/4	BST-2	0.17	SST-2	0.15	1/4-18	1.54	0.81	0.94
3/8	BST-3	0.26	SST-3	0.24	3/8-18	1.59	1.00	1.16
1/2	BST-4	0.59	SST-4	0.37	1/2-14	1.98	1.13	1.30
3/4	BST-6	0.62	SST-6	0.57	3/4-14	2.15	1.44	1.66
1	BST-8	0.99	SST-8	0.93	1-11 1/2	2.43	1.75	2.02
1-1/4	BST-10	1.38	-	-	1 1/4-11 1/2	2.44	2.00	2.51
1-1/2	BST-12	1.42	-	-	1 1/2-11 1/2	2.88	2.50	3.00

Male Pipe Thread

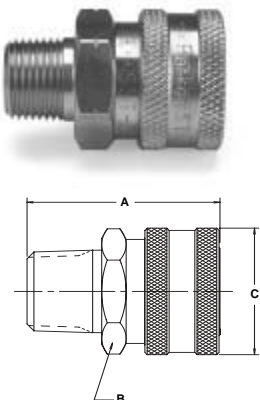

Body Size (in.)	Part No.		Part No.		Thread Size NPTF	Dimensions (in.)		
	Brass	Wt. (LB.) P/Piece	Type 303 Stainless	Wt. (LB.) P/Piece		Overall Length	Wrench Flats	Largest Diameter
						A	B	C
1/8	BST-1M	0.05	SST-1M	0.05	1/8-27	1.06	0.56	0.69
1/4	BST-2M	0.16	SST-2M	0.16	1/4-18	1.69	0.81	0.81
3/8	BST-3M	0.25	SST-3M	0.21	3/8-18	1.75	1.00	1.16
1/2	BST-4M	0.34	SST-4M	0.31	1/2-14	1.94	1.13	1.30
3/4	BST-6M	-	SST-6M	0.49	3/4-14	2.17	1.44	1.66
1	BST-8M	0.85	SST-8M	0.08	1-11 1/2	2.53	1.75	2.02

Hydraulic Quick Couplings

High Flow Couplings ST Series

Nipples

Female Pipe Thread

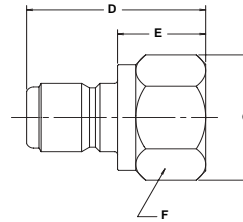

Body Size (in.)	Part No. Brass	Wt. (LB.) P/Piece	Part No. Steel	Wt. (LB.) P/Piece	Part No. Type 303 Stainless	Wt. (LB.) P/Piece	Thread Size NPTF	Dimensions (in.)			
								Overall Length	Exposed Length	Hex Size	Largest Dia.
								D	E	F	G
1/8	BST-N1	0.03	ST-N1	0.03	SST-N1	0.02	1/8-27	.98	0.57	0.56	0.65
1/4	BST-N2	0.07	ST-N2	0.07	SST-N2	0.07	1/4-18	1.46	0.74	0.75	0.87
3/8	BST-N3	0.12	ST-N3	0.11	SST-N3	0.11	3/8-18	1.62	0.96	.088	1.59
1/2	BST-N4	0.23	ST-N4	0.21	SST-N4	0.21	1/2-14	1.85	0.95	1.13	1.30
3/4	BST-N6	0.33	ST-N6	0.32	SST-N6	0.32	3/4-14	2.15	1.09	1.38	1.59
1	BST-N8	0.52	ST-N8	0.49	SST-N8	0.48	1-11 1/2	2.35	1.18	1.63	1.88
1 1/4	BST-N10	0.85	-	-	-	-	1 1/4-11 1/2	2.38	1.11	2.00	2.31
1 1/2	BST-N12	1.45	-	-	-	-	1 1/2-11 1/2	2.81	1.17	2.38	2.74

Nipples

Male Pipe Thread

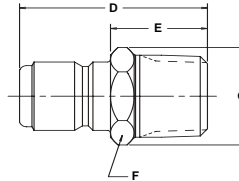

Body Size (in.)	Part No. Brass	Wt. (LB.) P/Piece	Part No. Steel	Wt. (LB.) P/Piece	Part No. Type 303 Stainless	Wt. (LB.) P/Piece	Thread Size NPTF	Dimensions (in.)			
								Overall Length	Exposed Length	Hex Size	Largest Dia.
								D	E	F	G
1/8	BST-N1M	0.02	ST-N1M	0.02	SST-N1M	0.02	1/8-27	1.04	0.63	0.44	0.51
1/4	BST-N2M	0.06	ST-N2M	0.05	SST-N2M	0.05	1/4-18	1.53	0.81	0.56	0.65
3/8	BST-N3M	0.08	ST-N3M	0.07	SST-N3M	0.08	3/8-18	1.69	0.86	0.69	0.79
1/2	BST-N4M	0.15	ST-N4M	0.13	SST-N4M	0.13	1/2-14	1.94	1.01	0.88	1.01
3/4	BST-N6M	0.23	ST-N6M	0.21	SST-N6M	0.22	3/4-14	2.19	1.11	1.06	1.23
1	BST-N8M	0.46	ST-N8M	0.43	SST-N8M	0.43	1-11 1/2	2.51	1.34	1.38	1.59
1 1/4	BST-N10M	0.96	-	-	-	-	1 1/4-11 1/2	2.85	1.60	1.88	2.17
1 1/2	BST-N12M	1.46	-	-	-	-	1 1/2-11 1/2	3.25	1.59	2.13	2.45

Replacement Parts

ST Series

ST Series O-Rings	Body Size (in.)			
	1/8	1/4	3/8	1/2
Standard Nitrile*	50001-010-0010	50001-110-0010	50001-112-0010	50001-114-0010

ST Series O-Rings	Body Size (in.)			
	3/4	1	1-1/4	1-1/2
Standard Nitrile*	50001-212-0010	50001-217-0010	50001-221-0010	50001-327-0010

* Other compounds available are Ethylene Propylene, Fluorocarbon, Neoprene (Contact the division for compound availability)





Applications

Parker Water Service Couplings are used anywhere water hoses are connected and disconnected frequently. They are used on a wide variety of applications including garden hoses, wash down systems, and mobile water tank lines. The unvalved design permits maximum flow with minimum pressure drop.

Specifications

Body Size (in.)	3/4"
Rated Pressure (PSI)	200
Rated Flow (GPM)	28
Temperature Range (std seals)	-40°F to +250°F

Features

- Brass and stainless steel construction for heavy duty service.
- Durable 4-ball locking mechanism for secure connections.
- Quality, temperature-resistant Nitrile seals for a leak-free service life.

Coupler

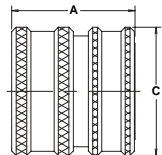

Body Size (in.)	Part No.	Thread Size NH	Overall Length A	Largest Diameter C	Wt. (LB.) P/Piece
3/4	1163-60	3/4-11 1/2	1.16	1.21	0.12

Nipple

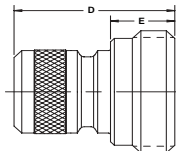

Body Size (in.)	Part No.	Thread Size NH	Overall Length D	Exposed Length E	Wt. (LB.) P/Piece
3/4	1163-61	3/4-11 1/2	1.25	.50	0.08



Applications

HO Series couplings are used in a wide variety of applications. HO couplings are used in refineries, petrochemical plants and paper and pulp mills for connecting hose lines for high pressure hydro-blasting of boilers and pipe lines. They are also used in oil fields on hose lines for internal and external pressure testing of tubing.

Note: Protective dust plugs and caps play a crucial role in the life of a quick coupling and no purchase of a hydraulic quick coupling is complete without the selection of an appropriate dust plug and cap. See pages noted in Table of Contents for hydraulic couplings dust plugs and caps for the full line of hydraulic couplings.

Specifications

Body Size (in.)	1/4	3/8	1/2
Rated Pressure (PSI)	15,000	15,000	10,000
Rated Flow (GPM)	3	6	12
Temperature Range (std seals)	-40° to +250°F		

Features

- For high pressure applications: working pressures to 15,000 PSI (1,050 Bar) for the 1/4" and 3/8" sizes; to 10,000 PSI (700 Bar) for the 1/2" size.
- No internal valving to restrict flow.
- Made of steel with electroless nickel plating for corrosion resistance.
- Standard sleeve-lock feature which helps prevent accidental disconnect.
- Standard Nitrile Body O-Ring. Backed up by PTFE washer to prevent seal extrusion.

Couplers

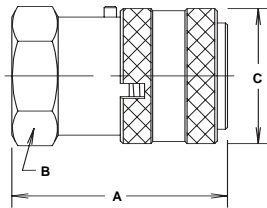

Body Size (in.)	Part No.	Thread Size NPSF	Dimensions (in.)				Wt. (LB.) P/Piece
			Overall Length	Hex Size	Largest Diameter		
			A	B	C		
1/4	HO-251-4FP	1/4-18	1.67	0.94	1.06	0.24	
3/8	HO-371-6FP	3/8-18	1.67	0.94	1.06	0.22	
1/2	HO-501-8FP	1/2-14	2.03	1.25	1.62	0.52	

Nipples

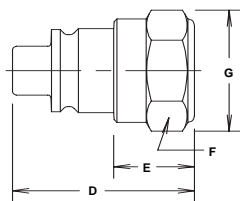

Body Size (in.)	Part No.	Thread Size NPSF	Dimensions (in.)				Wt. (LB.) P/Piece
			Overall Length	Exposed Length	Hex Size	Largest Diameter	
			D	E	F	G	
1/4	HO-252-4FP	1/4-18	1.40	0.66	0.81	0.94	0.10
3/8	HO-372-6FP	3/8-18	1.44	0.70	0.94	1.08	0.12
1/2	HO-502-8FP	1/2-14	2.03	0.86	1.12	1.30	0.26

NPSF – National Pipe Straight Fuel



Features

- Parker DM Series offer double shut-off valving and push-to-connect operation in a small envelope size.
- They are constructed of nickel plated brass and are available in 1/8" body size only.
- Standard seals are Fluorocarbon, but other seal material is available upon request. See the Coupling Selection and Ordering Information Guide at the beginning of Section A and the Fluid Compatibility Chart at the end of this catalog for optional materials.

Performance

DM Series (1/8")
Test Fluid: Water

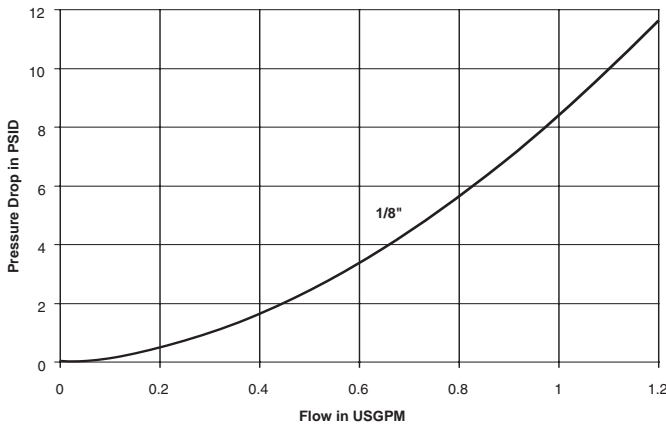

Applications

Typical applications include dental equipment, lubrication equipment, fluid transfer and coolant lines.

Specifications

Body Size (in.)	1/8"
Temperature Range	-15°F to +400°F
Rated Pressure	250 PSI
Locking Device	5 Balls
Rated Flow (GPM)	0.8

How To Order

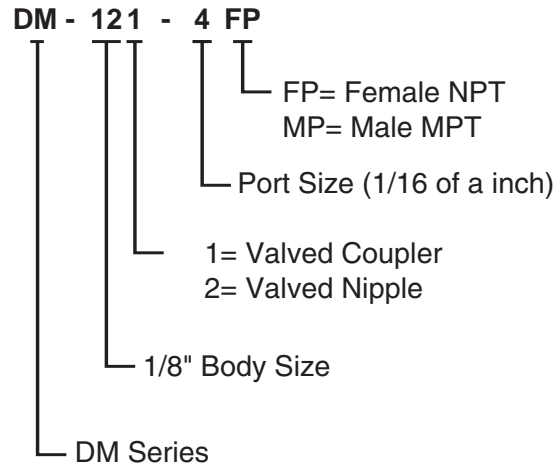

Couplers

Female Pipe Thread

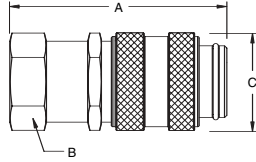

Body Size (in.)	New Part No.	Old Part No.	Thread Size NPTF	Dimensions (in.)			Largest Diameter	Wt. (LB)	P/Price
				Overall Length	Hex Size	Hex Size			
				A	B	C			
1/8	DM-121-2FP	CDM02-2-2Y	1/8-27	1.42	0.55	0.63	.06		
1/8	DM-121-4FP	CDM02-2-4Y	1/4-18	1.81	0.67	0.78	.10		

Male Pipe Thread

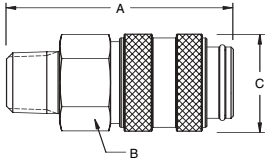

Body Size (in.)	New Part No.	Old Part No.	Thread Size NPTF	Dimensions (in.)			Largest Diameter	Wt. (LB)	P/Price
				Overall Length	Hex Size	Hex Size			
				A	B	C			
1/8	DM-121-2MP	CDM01-2-2Y	1/8-27	1.50	0.55	0.63	.06		
1/8	DM-121-4MP	CDM01-2-4Y	1/4-18	1.61	0.55	0.63	.07		

Nipples

Female Pipe Thread

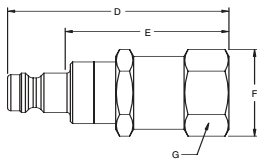

Body Size (in.)	New Part No.	Old Part No.	Thread Size NPTF	Dimensions (in.)				Largest Diameter	Wt. (lb)	P/Price
				Overall Length	Exposed Length*	Hex Size	Hex Size			
				D	E	F	G			
1/8	DM-122-2FP	NDM02-2-2Y	1/8-27	1.56	1.03	0.55	0.63	.05		
1/8	DM-122-4FP	NDM02-2-4Y	1/4-18	1.97	1.44	0.67	0.78	.09		

* This dimension represents the portion that is exposed when a nipple is inserted into a Parker DM Series coupler.

Male Pipe Thread

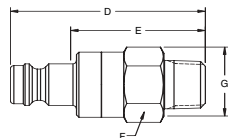

Body Size (in.)	New Part No.	Old Part No.	Thread Size NPTF	Dimensions (in.)				Largest Diameter	Wt. (lb)	P/Price
				Overall Length	Exposed Length*	Hex Size	Hex Size			
				D	E	F	G			
1/8	DM-122-2MP	NDM01-2-2Y	1/8-27	1.65	1.12	0.55	0.63	.05		
1/8	DM-122-4MP	NDM01-2-4Y	1/4-18	1.77	1.24	0.55	0.63	.06		

* This dimension represents the portion that is exposed when a nipple is inserted into a Parker DM Series coupler.

Applications

Parker offers a complete line of dust plugs and caps for their hydraulic quick couplings. Each series shown in this catalog has a dust plug and cap specifically designed to be used with that style of coupling.

Dust plugs and caps serve a twofold function. They keep the mating surface clean and free of contamination and protect the critical mating elements of the coupling halves when they are disconnected. In this way the nipple is protected from damage that would make the total coupling unusable.

Protective dust plugs and caps play a crucial role in the use of quick couplings and no purchase of a hydraulic quick coupling is complete without the selection of an appropriate dust plug and cap. When ordering the dust cap/plug body size must correspond to that of the coupler or nipple.

Parker's full line of dust plugs and caps can be found below and on the following pages.

Dust Plug: Used on Coupler (female half)

Dust Cap: Used on Nipple (male half)

Dust Plugs

60 Series



Body Size (in.)	Dust Plug Part No. Aluminum	Dust Plug Part No. Rubber	Dust Cap Part No. Aluminum	Dust Cap Part No. Rubber
1/8	H1-65	H1-65M	H1-66	H1-66M
1/4	H2-65	H2-65M	H2-66	H2-66M
3/8	H3-65	H3-65M	H3-66	H3-66M
1/2	H4-65	H4-65M	H4-66	H4-66M
3/4	H6-65	H6-65M	H6-66	H6-66M
1	H8-65	H8-65M	H8-66	H8-66M
1 1/2	H12-65	NA	H12-66	NA
2 1/2	H20P-65	NA	H20P-66	NA

NA = Not Available

6600 Series



Body Size (in.)	Dust Plug Part No. Rubber	Dust Cap Part No. Rubber
1/4	H1-65M	H1-66M
3/8	TR-37	TR-37
1/2	5205-4M	5209-4M
3/4	6659-12M	6657-12M
1	6659-16M	6657-16M

SM Series



Body Size (in.)	Dust Plug Part No.	Dust Cap Part No.	Material
1/4	PL-25	N/A	Plastic
1/4	PR-25	CR-25	Rubber
1/4	P-25	C-25	Aluminum
1/2	DP-50	DC-50	Rubber
1/2	P-50	C-50	Aluminum
3/4	P-75	C-75	Aluminum

Hydraulic Quick Couplings

Dust Plugs and Dust Caps

HP Series

Body Size (in.)	Dust Plug Part Number Rubber	Dust Cap Part No. Rubber
1	HPP-100	HPC-100
1 1/2	HPP-150	HPC-150

4000 Series & 5000 Series



Body Size (in.)	Dust Plug Part No. Steel	Dust Plug Part No. Rubber	Dust Cap Part No. Steel	Dust Cap Part No. Rubber
1/4	–	5205-2M*	–	5209-2M*
3/8	–	5205-3	–	5209-3
1/2	5005-4	5205-4M*	5009-4	5209-4M*
3/4	–	5205-5	–	5209-5
1	–	5205-6	–	5209-6

* Designates all rubber material. (Not shown at left)

NS Series



Body Size (in.)	Part Number Rubber
3/8	NR-37
1/2	NR-50
3/4	NR-75
1	NR-100

Protective cover fits either half.

FF Series, FC Series, FH Series & FS Series



Body Size (in.)	Dust Plug Part Number Rubber	Dust Cap Part No. Rubber
1/4*	FR-25	FR-25
3/8	NR-50	NR-37
1/2	FR-501	FR-502
3/4	FR-751	FR-752
1	FR-1001	FR-1002

* FR-25 fits both halves

FE Series, FEC Series, FEM Series



Body Size (in.)	Dust Plug Part Number Rubber	Dust Cap Part No. Rubber
1/4	FR-25	FR-25
3/8	NR-50	NR-37
1/2	FR-501	FER-502
3/4	FR-751	FER-752
1	FR-1001	

6100 Series



Body Size (in.)	Dust Plug Part No. Brass	Dust Cap Part No. Brass
3/4	6109-08	6108-08
1	6109-16	6108-16
1 1/4	6109-20	6108-20
1 1/2	6109-24	6108-24

Hydraulic Quick Couplings

Dust Plugs and Dust Caps

9200 Series



Body Size (in.)	Dust Cap. Part No. Rubber
1/2	9507-4-1

3000 Series



Body Size (in.)	Dust Plug Part No. Steel	Dust Cap Part No. Steel
1/4	3005-2	3009-2
3/8	3005-3	3009-3

TC Series



Body Size (in.)	Part Number Rubber
3/8	TR-37

Protective cover fits either half.

HO Series



TR-37 Plug / Cap



DC-50

Body Size (in.)	Used With HO Series Coupler/Nipple Part No.	Dust Plug Part No.	Dust Cap Part No.	Material
1/4	HO-251/252-4FP	TR-37	TR-37	Rubber
3/8	HO-371/372-6FP	TR-37	TR-37	Rubber
1/2	HO-501-8FP	DP-50	-	Rubber
1/2	HO-502-8FP	-	DC-50	Rubber

When ordering Parker coupler bodies and nipples, please state the part number of each type of coupler body and each type of nipple desired. List coupler bodies and nipples as separate items rather than in combinations. Be sure to double check thread or hose sizes of items required.

Many of Parker's coupling products are available with unique non-standard options well suited to very specific applications. Examples of unusual end use applications might include: high temperatures (above 250° F), extremely caustic/corrosive solutions passing through the coupling, external/environmental corrosion situations, or other high wear and tear situations such as dragging the product along the ground. Please see the Fluid Compatibility Chart at the end of the catalog for a guide in selecting material for various media. It is always recommended that the Quick Coupling Division be contacted with any questions concerning specific product application needs.

Typically, a prefix or suffix is added to the base part number to specify a non-standard O-ring seal, or special option such as a sleeve lock. The Optional Seals Suffix chart illustrates the designations.

Please Note: Certain couplings series have additional "Special Order Information" which should be referred to in ordering those products. If applicable to the product, "Special Order Information" is found next to the Features and Specifications charts.

Operation
<ul style="list-style-type: none"> • Prefix "HD" for heavy duty nipple • Suffix "SL" for coupler sleeve-lok • Suffix "P" for poppet valve • Suffix "BP" for Push-lok hose barb • Suffix "VA" for Valve Actuator

Optional Seals Suffix*				
No suffix is required when ordering products with the standard Nitrile seals. When specifying an optional seal, refer to the following chart to determine the appropriate suffix.**				
Coupling Series	Ethylene Propylene	Fluoro-carbon	Neoprene	Perfluoro-elastomer
60 Series	W	Y	Z	****
6600 Series	W	Y	Z	****
SM Series	E5	E4	E12	****
HP Series	E5	E4	E12	****
4000 Series	W	Y	Z	N/A
4200 Series	W	Y	Z	N/A
NS Series	E5	E4	N/A	****
FF Series Std. is E49	E5	E4	N/A	****
FE Series	E5	E4	N/A	****
FH Series	E5	E4	N/A	****
FS Series	E5	STD	E12	****
6100 Series	W	Y	Z	N/A
5000 Series	W	Y	Z	N/A
8200 Series	W	Y	Z	N/A
9200 Series	W	Y	Z	N/A
3000 Series	Available with Polyurethane only (no suffix needed)			
TC Series	Available with Fluorocarbon only (no suffix needed)			
1141 Series	Available with Polyurethane only (no suffix needed)			
ST Series	W	Y	Z	
Water Service	Available with Nitrile only			
WB Series	E5	E4	E12	N/A
HO Series	E5	E4	E12	N/A
Moldmate Series Std. is Silicone	N/A	Y***	N/A	N/A

*To select proper seal materials, see Fluid Compatibility Chart in Appendices section, or contact your Parker Quick Coupling Distributor.

**N/A = Not Available; STD = Standard (No Suffix Needed)

*** Fluorocarbon seal available for use only with oil based media, not water glycol.

**** Contact the division for Perfluoroelastomer Seal Options.



Description

These popular coupling key chains are now available from the Quick Coupling Division. The new key chains are an anodized aluminum construction available in an array of colors. Key chains can be ordered using part numbers in the following chart.

Part Number	Sleeve Color
KEY-BK	Black
KEY-BU	Blue
KEY-GR	Green
KEY-RD	Red
KEY-CL	Clear
KEY-NI	Old style nickel plated

Thermoplastic Couplings

Thermoplastic Couplings

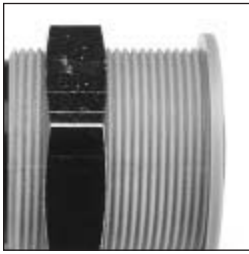

Coupling Selection Guide	C-3	PF Series	C-8
Spectrum Series	C-4	Specifications	C-8
Specifications	C-4	Couplers	C-9
Couplers	C-5	Nipples	C-9
Nipples - Unvalved	C-6	Dust Caps and Plugs	C-9
Nipples - Valved	C-7	Ordering Information	C-10

Thermoplastic Couplings

	Valving	Coupler Style	Body Size (in.)	Material	Locking Mechanism	Std. Seal Material	Temp Range**	Rate Pressure
PF Series	Flush Face Non-Spill	Push-to-Connect	1/2", 1" & 2"	Polypropylene/ Stainless and/or Kynar/Hastelloy	Pawl lock	Fluoro-carbon	+40° to +140° F	30 to 100 PSI
Spectrum™ Series	Valved or Unvalved	Push-to-Connect	1/8" & 3/8"	Acetal 316 SS	Finger Lock	Nitrile	0°F to 180°F	0 to 145 PSI
Spectrum™ Series	Valved or Unvalved	Push-to-Connect	1/8" & 3/8"	PVDF/SS 316 SS	Finger Lock	Fluoro-carbon	0°F to 250°F	0 to 115 PSI
Spectrum™ Series	Valved or Unvalved	Push-to-Connect	3/8"	PVDF/ PEEK™	Finger Lock	Fluoro-carbon	0°F to 250°F	15 to 115 PSI

Ordering Information

Optional Seals Suffix*			
No suffix is required when ordering products with the standard Fluorocarbon seals. When specifying an optional seal, refer to the following chart to determine the appropriate suffix.**			
Coupling Series	Ethylene Propylene	Neoprene	Perfluoro-elastomer
PF Series	E5	E12	E47

*To select proper seal materials, see Fluid Compatibility Chart in Appendices section, or contact your Parker Quick Coupling Distributor.

**N/A = Not Available; STD = Standard (No Suffix Needed)

Spectrum Series – are available with these materials	
Body Material	Seal Material
Acetal/SS	Nitrile
PVDF/SS	Fluorocarbon
PVDF/PEEK™	Fluorocarbon



Applications

Parker's Spectrum™ Series couplers are the most advanced engineered thermoplastic couplings available. Spectrum Series couplings combine compact size, high flow capability, and light weight design to meet a broad range of coupling applications. Three material combinations allow the couplings to be used in markets as diverse as chemical processing, automation equipment, semi-conductor and food processing. Spectrum Series can be used in many applications previously reserved for stainless steel couplings.

Features

- Excellent Chemical Compatibility
- Three Material Combinations: Acetal/SS, PVDF/SS and PVDF/PEEK™
- High Flow Capacity
- Easy Push-To-Connect Operation
- Available Valved and Unvalved
- Flexible Modular Design
- Four Point 360° Locking Mechanism
- Temperatures Up To 250° F
- Panel Mounting Option

Performance

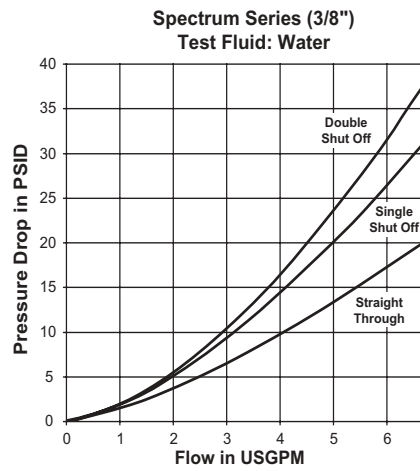
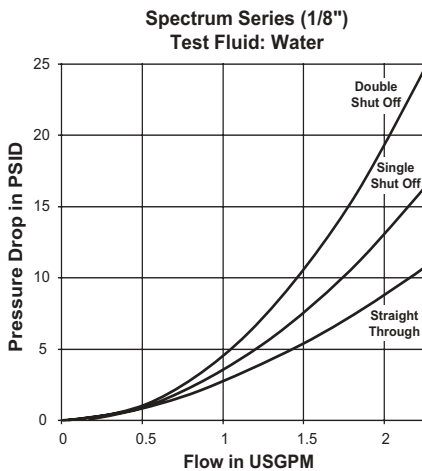

How To Order

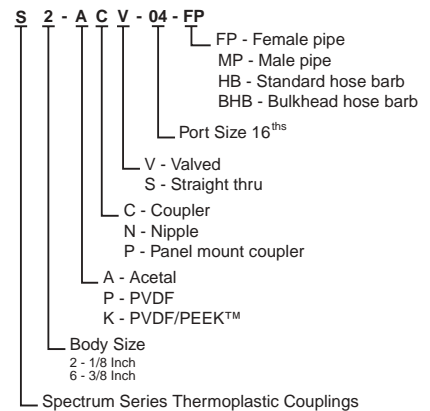

Specifications

	Acetal/SS (black with grey sleeve)		PVDF/SS (translucent with green sleeve)		PVDF/PEEK™ (translucent)
Body Size	1/8	3/8	1/8	3/8	3/8
Pressure Range	0-145 psi (0-10 bar)	0-145 psi (0-10 bar)	0-115 psi (0-8 bar)	0-115 psi (0-8 bar)	15-115 psi (1-8 bar)
Temperature Range	0° F to 180° F (-20° C to +80° C)	0° F to 180° F (-20° C to +80° C)	0° F to 250° F (-20° C to +120° C)	0° F to 250° F (-20° C to +120° C)	0° F to 250° F (-20° C to +120° C)
Rated Flow	1.5 GPM (5.6 lpm)	4.5 GPM (17 lpm)	1.5 GPM (5.6 lpm)	4.5 GPM (17 lpm)	4.5 GPM (17 lpm)
Body Material	Acetal	Acetal	PVDF	PVDF	PVDF
Spring Material	316 SS	316 SS	316 SS	316 SS	PEEK™
Seal Material	Nitrile	Nitrile	Fluorocarbon	Fluorocarbon	Fluorocarbon

Couplers

Female Pipe

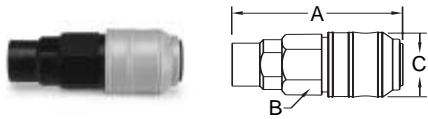

Body Size (in.)	Acetal* Part No.	PVDF* Part No.	PVDF/PEEK™* Part No.	Port NPT	Overall Length	Hex Size	Largest Diameter
						A	B
1/8	S2-ACV-02-FP	S2-PCV-02-FP	—	1/8-27	2.15	.67	.82
1/8	S2-ACV-04-FP	S2-PCV-04-FP	—	1/4-18	2.34	.67	.82
3/8	S6-ACV-04-FP	S6-PCV-04-FP	S6-KCV-04-FP	1/4-18	2.63	.82	1.02
3/8	S6-ACV-06-FP	S6-PCV-06-FP	S6-KCV-06-FP	3/8-18	2.63	.82	1.02
3/8	S6-ACV-08-FP	S6-PCV-08-FP	S6-KCV-08-FP	1/2-14	3.10	.82	1.02

Male Pipe

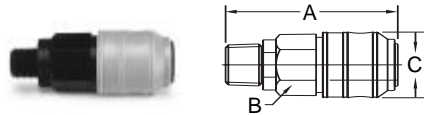

Body Size (in.)	Acetal* Part No.	PVDF* Part No.	PVDF/PEEK™* Part No.	Port NPT	Overall Length	Hex Size	Largest Diameter
						A	B
1/8	S2-ACV-02-MP	S2-PCV-02-MP	—	1/8-27	2.04	.67	.82
1/8	S2-ACV-04-MP	S2-PCV-04-MP	—	1/4-18	2.15	.67	.82
3/8	S6-ACV-04-MP	S6-PCV-04-MP	S6-KCV-04-MP	1/4-18	2.90	.82	1.02
3/8	S6-ACV-06-MP	S6-PCV-06-MP	S6-KCV-06-MP	3/8-18	2.77	.82	1.02
3/8	S6-ACV-08-MP	S6-PCV-08-MP	S6-KCV-08-MP	1/2-14	3.10	.82	1.02

Hose Barb

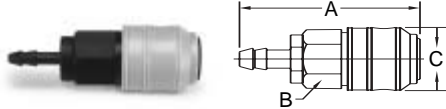

Body Size (in.)	Acetal* Part No.	PVDF* Part No.	PVDF/PEEK™* Part No.	Hose I.D.	Overall Length	Hex Size	Largest Diameter
						A	B
1/8	S2-ACV-03-HB	S2-PCV-03-HB	—	3/16 (4 mm)	2.34	.67	.82
1/8	S2-ACV-04-HB	S2-PCV-04-HB	—	1/4 (6 mm)	2.34	.67	.82
3/8	S6-ACV-04-HB	S6-PCV-04-HB	S6-KCV-04-HB	1/4 (6 mm)	3.19	.82	1.02
3/8	S6-ACV-06-HB	S6-PCV-06-HB	S6-KCV-06-HB	3/8 (9 mm)	3.19	.82	1.02
3/8	S6-ACV-08-HB	S6-PCV-08-HB	S6-KCV-08-HB	1/2 (13 mm)	3.31	.82	1.02

Bulkhead Hose Barb

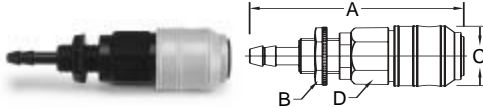

Body Size (in.)	Acetal* Part No.	PVDF* Part No.	PVDF/PEEK™* Part No.	Hose I.D.	Overall Length	Hex Size	Largest Diameter	Bulkhead Hex
						A	B	C
1/8	S2-ACV-03-BHB	S2-PCV-03-BHB	—	3/16 (4 mm)	2.89	.67	.82	.67
1/8	S2-ACV-04-BHB	S2-PCV-04-BHB	—	1/4 (6 mm)	2.89	.67	.82	.67

Panel Mount Couplers

Female Pipe

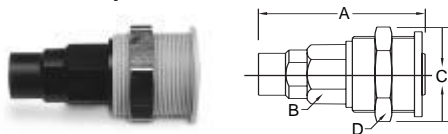

Body Size (in.)	Acetal* Part No.	PVDF* Part No.	PVDF/PEEK™* Part No.	Hose I.D.	Overall Length	Hex Size	Largest Diameter	Bulkhead Hex
						A	B	C
1/8	S2-APV-02-FP	S2-PPV-02-FP	—	1/8-27	2.04	.67	1.10	1.06
1/8	S2-APV-04-FP	S2-PPV-04-FP	—	1/4-18	2.16	.67	1.10	1.06

Hose Barb

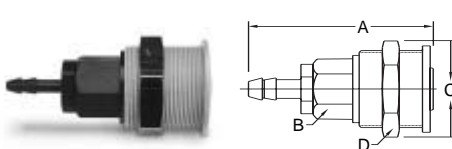

Body Size (in.)	Acetal* Part No.	PVDF* Part No.	PVDF/PEEK™* Part No.	Hose I.D.	Overall Length	Hex Size	Largest Diameter	Bulkhead Hex
						A	B	C
1/8	S2-APV-03-HB	S2-PPV-03-HB	—	3/16 (4 mm)	2.34	.67	1.10	1.06
1/8	S2-APV-04-HB	S2-PPV-04-HB	—	1/4 (6 mm)	2.34	.67	1.10	1.06

* NOTE: To Order Unvalved Coupler replace "V" with an "S".

Nipples – Unvalved

Female Pipe

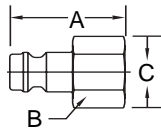

Body Size (in.)	Acetal Part No.	PVDF Part No.	PVDF/PEEK™ Part No.	Port NPT	Overall Length	Hex Size	Largest Diameter
					A	B	C
1/8	S2-ANS-02-FP	S2-PNS-02-FP	—	1/8-27	1.02	.55	.62
1/8	S2-ANS-04-FP	S2-PNS-04-FP	—	1/4-18	1.18	.67	.76
3/8	S6-ANS-04-FP	S6-PNS-04-FP	—	1/4-18	1.52	.67	.73
3/8	S6-ANS-06-FP	S6-PNS-06-FP	—	3/8-18	1.52	.83	.91
3/8	S6-ANS-08-FP	S6-PNS-08-FP	—	1/2-14	1.68	.98	1.09

Male Pipe

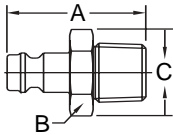

Body Size (in.)	Acetal Part No.	PVDF Part No.	PVDF/PEEK™ Part No.	Port NPT	Overall Length	Hex Size	Largest Diameter
					A	B	C
1/8	S2-ANS-02-MP	S2-PNS-02-MP	—	1/8-27	1.08	.55	.62
1/8	S2-ANS-04-MP	S2-PNS-04-MP	—	1/4-18	1.24	.67	.76
3/8	S6-ANS-04-MP	S6-PNS-04-MP	—	1/4-18	1.64	.67	.73
3/8	S6-ANS-06-MP	S6-PNS-06-MP	—	3/8-18	1.64	.83	.91
3/8	S6-ANS-08-MP	S6-PNS-08-MP	—	1/2-14	1.83	.94	1.04

Hose Barb

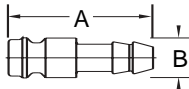

Body Size (in.)	Acetal Part No.	PVDF Part No.	PVDF/PEEK™ Part No.	Hose I.D.	Overall Length	Largest Diameter
					A	B
1/8	S2-ANS-03-HB	S2-PNS-03-HB	—	3/16 (4 mm)	1.26	.34
1/8	S2-ANS-04-HB	S2-PNS-04-HB	—	1/4 (6 mm)	1.26	.34
3/8	S6-ANS-04-HB	S6-PNS-04-HB	—	1/4 (6 mm)	1.86	.71
3/8	S6-ANS-06-HB	S6-PNS-06-HB	—	3/8 (9 mm)	1.87	.71
3/8	S6-ANS-08-HB	S6-PNS-08-HB	—	1/2 (13 mm)	1.99	.71

Bulkhead Hose Barb

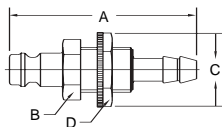

Body Size (in.)	Acetal Part No.	PVDF Part No.	PVDF/PEEK™ Part No.	Hose I.D.	Overall Length	Hex Size	Largest Diameter	Bulkhead Hex
					A	B	C	D
1/8	S2-ANS-03-BHB	S2-PNS-03-BHB	—	3/16 (4 mm)	1.97	.55	.64	.55
1/8	S2-ANS-04-BHB	S2-PNS-04-BHB	—	1/4 (6 mm)	1.97	.55	.77	.67

Nipples –Valved

Female Pipe

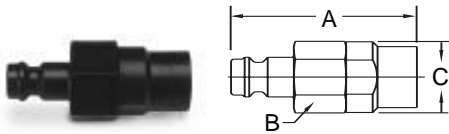

Body Size (in.)	Acetal Part No.	PVDF Part No.	PVDF/PEEK™ Part No.	Port NPT	Overall Length	Hex Size	Largest Diameter
					A	B	C
1/8	S2-ANV-02-FP	S2-PNV-02-FP	—	1/8-27	1.61	.67	.76
1/8	S2-ANV-04-FP	S2-PNV-04-FP	—	1/4-18	1.80	.67	.76
3/8	S6-ANV-04-FP	S6-PNV-04-FP	S6-KNV-04-FP	1/4-18	2.02	.83	.91
3/8	S6-ANV-06-FP	S6-PNV-06-FP	S6-KNV-06-FP	3/8-18	2.02	.83	.91
3/8	S6-ANV-08-FP	S6-PNV-08-FP	S6-KNV-08-FP	1/2-14	2.49	.83	.91

Male Pipe

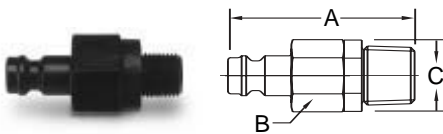

Body Size (in.)	Acetal Part No.	PVDF Part No.	PVDF/PEEK™ Part No.	Port NPT	Overall Length	Hex Size	Largest Diameter
					A	B	C
1/8	S2-ANV-02-MP	S2-PNV-02-MP	—	1/8-27	1.49	.67	.76
1/8	S2-ANV-04-MP	S2-PNV-04-MP	—	1/4-18	1.80	.67	.76
3/8	S6-ANV-04-MP	S6-PNV-04-MP	S6-KNV-04-MP	1/4-18	2.24	.83	.91
3/8	S6-ANV-06-MP	S6-PNV-06-MP	S6-KNV-06-MP	3/8-18	2.16	.83	.91
3/8	S6-ANV-08-MP	S6-PNV-08-MP	S6-KNV-08-MP	1/2-14	2.49	.83	.91

Hose Barb

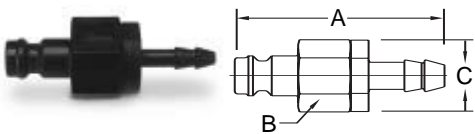

Body Size (in.)	Acetal Part No.	PVDF Part No.	PVDF/PEEK™ Part No.	Hose I.D.	Overall Length	Hex Size	Largest Diameter
					A	B	C
1/8	S2-ANV-03-HB	S2-PNV-03-HB	—	3/16 (4 mm)	1.80	.67	.76
1/8	S2-ANV-04-HB	S2-PNV-04-HB	—	1/4 (6 mm)	1.80	.67	.76
3/8	S6-ANV-04-HB	S6-PNV-04-HB	S6-KNV-04-HB	1/4 (6 mm)	2.59	.82	.91
3/8	S6-ANV-06-HB	S6-PNV-06-HB	S6-KNV-06-HB	3/8 (9 mm)	2.59	.82	.91
3/8	S6-ANV-08-HB	S6-PNV-08-HB	S6-KNV-08-HB	1/2 (13 mm)	2.71	.82	.91

Bulkhead Hose Barb

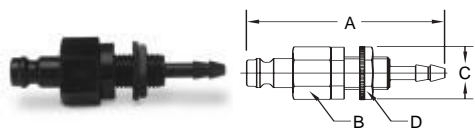

Body Size (in.)	Acetal Part No.	PVDF Part No.	PVDF/PEEK™ Part No.	Hose I.D.	Overall Length	Hex Size	Largest Diameter	Bulkhead Hex
					A	B	C	D
1/8	S2-ANV-03-BHB	S2-PNV-03-BHB	—	3/16 (4 mm)	2.35	.67	.76	.55
1/8	S2-ANV-04-BHB	S2-PNV-04-BHB	—	1/4 (6 mm)	2.35	.67	.76	.55



Applications

- Chemical Dispensing Systems
- Spray Application Equipment
- Mini Bulk Tanks
- Replacement for Banjo Style Camlok Fittings & Ball Valves
- Bulk Transfer Barrels

Specifications

Body Size	1/2"	1"	2"
Materials:	Polypropylene ⁽¹⁾		
Body	Polypropylene ⁽¹⁾		
Springs	316 Stainless Steel ⁽²⁾		
Seals	Fluorocarbon		
Rated Pressure (at 68° F)	100 PSI	60 PSI	100 PSI
Rated Flow	12 GPM	20 GPM	50 GPM
Pressure Drop at Rated Flow	11.3 PSI	3.4 PSI	4 PSI
Force to Connect	32 lbs.	54 lbs.	41 lbs.
Force to Disconnect	12 lbs.	17 lbs.	17 lbs.
Operating Temp.	+40°F to +140° F		
Storage Temp.	-20°F to +140° F		
Maximum Spillage per Disconnect	0.14 ml .01 cu. in.	1ml .06 cu. in. (1cc)	9 ml .5 cu. in.
Vacuum Rating	27.4 Hg	Contact Factory	Contact Factory

(1) Hastelloy™ & Kynar™ Coated available upon special request
 (2) Also available in EPDM, Nitrile, Neoprene, Perfluoroelastomer

Features

The Parker PF Series Dry Disconnect couplings virtually eliminate fluid loss upon disconnection and are designed to help meet the demand for closed system transfer and dispensing of chemicals and fluids with minimal environmental contamination. They can be used with concentrated or diluted industrial chemicals, fertilizers, herbicides, insecticides, fungicides or pesticides when transferring from bulk storage tanks, returnable containers, applicators, etc.

New 2" Size The new PF Series 2" body size is ideal for large bulk transfer of fluids and eliminating fluid spillage when connecting and disconnecting.

Additional features include:

- Rugged Glass filled Polypropylene construction for chemical compatibility and reduced cost.
- Push-to-connect design.
- Flush face valves exhibit minimal spillage upon connect or disconnect and air inclusion on connect, and enables ease of cleaning.
- PTFE coated Fluorocarbon tank gasket for improved chemical compatibility.
- 1" coupler has non-wetted springs. Spring options available for nipples include: hastelloy springs designated -640, or kynar coated springs designated -714 .

Performance

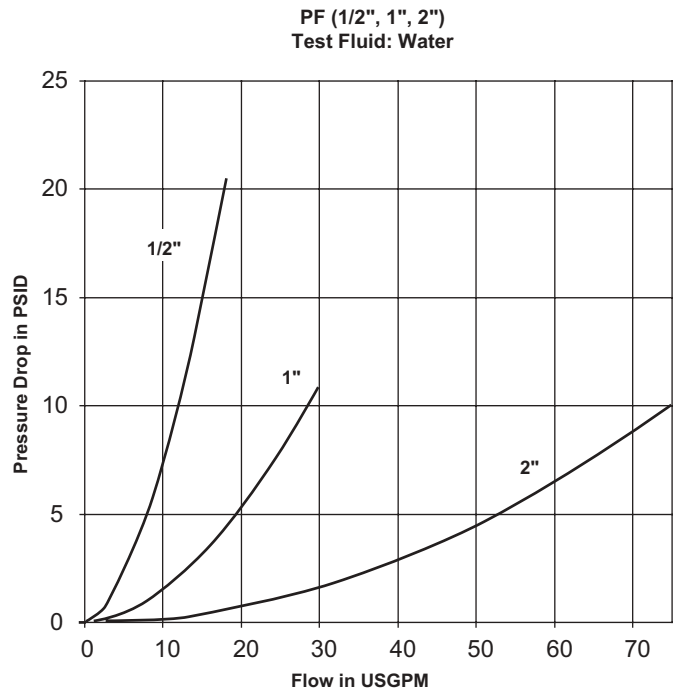

Thermoplastic Couplings

Non-Spill Couplings

PF Series – Non-Spill Chemical Transfer Couplings

Couplers

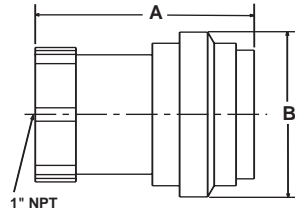

Body Size (in.)	Part No.	Port* Thread	Overall Length	Largest Diameter		Wrench Wt. (LB.)	
				A	B	Flats	P/Piece
1/2	PF-501-8FP	1/2"NPT	3.02	1.88	1.38	0.18	
1	PF-1001-16FP	1" NPT	3.99	3.00	1.99	0.53	
2	PF-2001-32FP	2" NPT	6.63	5.00	-	1.75	

* Female NPT Threads standard. For other port options contact the division.

Nipples

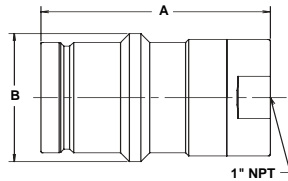

Body Size (in.)	Part No.	Port* Thread	Tank Mount Thread	Overall Length	Largest Diameter		Wrench Wt. (LB.)	
					A	B	Flats	P/Piece
1/2	PF-502-8FP	1/2" NPT	None	2.96	1.33	1.24	0.09	
1	PF-1002-16FP	1" NPT	None	3.92	2.20	1.87	0.26	
2	PF-2002-32FP	2" NPT	None	5.71	3.55	-	0.75	

* Female NPT Threads standard. For other port options contact the division.

Nipples - Tank Mount

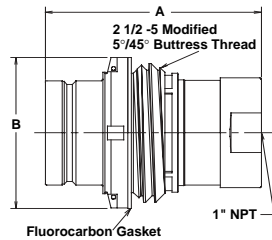

Body Size (in.)	Part No.	Port* Thread	Tank Mount Thread	Overall Length	Largest Diameter		Wrench Wt. (LB.)	
					A	B	Flats	P/Piece
1	PF-1002-32MB	1" NPT	Modified Buttress	3.92	2.75	1.87	0.33	
1	PF-1002-32MP	1" NPT	Modified NPS	3.92	2.75	1.87	0.31	

* Female NPT Threads standard. For other port options contact the division.

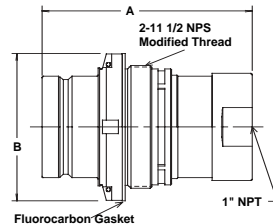

Dust Caps and Plugs

Coupler Dust Cap
FR-501



Nipple Dust Cap
FR-502

Nipple Dust Cap
PFR-1002



Nipple Dust Cap (Tank Mount)
PFR-1002-NS



Body Size (in.)	Coupler Dust Cap Part No.	Nipple Dust Cap Part No.	Material
1/2	FR-501	FR-502	Synthetic Rubber
1	None	PFR-1002	Ethylene Propylene
1	None	PFR-1002-NS*	Ethylene Propylene

* For use with Tank Mount Nipples

Thermoplastic Couplings

Ordering Information

When ordering Parker coupler bodies and nipples, please state the part number of each type of coupler body and each type of nipple desired. List coupler bodies and nipples as separate items rather than in combinations. Be sure to double check thread or hose sizes of items required.

Many of Parker's coupling products are available with unique non-standard options well suited to very specific applications. Examples of unusual end use applications might include: high temperatures (above 250° F), extremely caustic/corrosive solutions passing through the coupling, external/environmental corrosion situations, or other high wear and tear situations such as dragging the product along the ground. Please see the Fluid Compatibility Chart at the end of the catalog for a guide in selecting material for various media. It is always recommended that the Quick Coupling Division be contacted with any questions concerning specific product application needs.

Please Note: Certain couplings series have additional "Special Order Information" which should be referred to in ordering those products. If applicable to the product, "Special Order Information" is found next to the Features and Specifications charts.

Optional Seals Suffix*

No suffix is required when ordering products with the standard Fluorocarbon seals. When specifying an optional seal, refer to the following chart to determine the appropriate suffix.**

Coupling Series	Ethylene Propylene	Neoprene	Perfluoro-elastomer
PF Series	E5	E12	E35*** E47****

* To select proper seal materials, see Fluid Compatibility Chart in Appendices section, or contact your Parker Quick Coupling Distributor.

** N/A = Not Available; STD = Standard (No Suffix Needed)

*** Parofluor™

**** DuPont Kalrez™

Spectrum Series – are available with these materials

Body Material	Seal Material
Acetal/SS	Nitrile
PVDF/SS	Fluorocarbon
PVDF/PEEK™	Fluorocarbon

Swivels

General Introduction

Applications

Some common markets and applications for swivels are:

- Injection Molding
- Pulp and Paper
- Logging
- Refuse Trucks
- Utility Equipment
- Mobile Equipment
- Hose Reels
- Pressure Washers
- Machine Tools
- Steel Mills
- Palletizers
- And many more...

Table of Contents

Swivels

ApplicationsD-1

PS Series

Introduction	D-4
How To Order	D-5
In-Line	D-6
90°	D-15
Repair Kits	D-26
Seal Options	D-26

S Series

Introduction	D-27
How To Order	D-28
90°	D-29
Repair Kits	D-33
Seal Options	D-33

Introduction

The design and manufacturing processes vital to a swivel's quality are the cornerstone of the Quick Coupling Division's day to day operations. The PS Series Swivel is designed to meet the application needs and performance requirements of the market. Pressure capabilities up to 5000 psi, 1/4" through 2" body sizes, a variety of port options, zinc with yellow chromate or nickel plating and a wide range of seal options make the PS Series Swivels ideal for an array of dynamic applications.



Features

- Hardened bearing races for extended service life.
- Full flow design minimizes pressure drop for optimum system performance.
- Sealed bearing design isolates bearing race from media and environment.
- Reduced bearing load design minimizes wear in the bearing race and extends service life.
- PTFE back-up rings support primary seal for high-pressure applications.
- Zinc with yellow chromate plating for maximum corrosion resistance.
- Variety of seal options available.
- Three piece swivel design for sizes 1 1/4" through 2" for superior performance and service life.
- Precision needle bearings and ball bearings sized 1 1/4" through 2" for additional side load resistance.
- Polyurethane U-Cup primary seal standard for sizes 1 1/4" through 2".
- PS Series Swivels eliminate hose twist and torque that may cause premature hose failure.

Specifications

Body Size (in.)	1/4	3/8	1/2	3/4	1	1-1/4	1-1/2	2
Maximum Rated Pressure (PSI)	5000	5000	5000	5000	5000	4000	4000	3000
<i>Except the following port options in the noted size</i>								
03 (Male JIC 37°)							3000	2000
05 (Male SAE O-Ring Boss)								2500
06 (Female JIC 37°) 90° Housing Port				4000	3000	3000	2500	2000
06 (Female JIC 37°) In-Line Housing Port							3000	2000
07 (Female NPSM)			4600	3000	2600	2100	1650	1500
Temperature Range (std seals)	-40° to 250° F					-30° to 180° F		

Performance Data

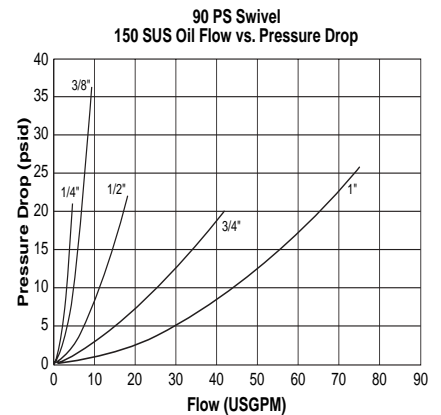
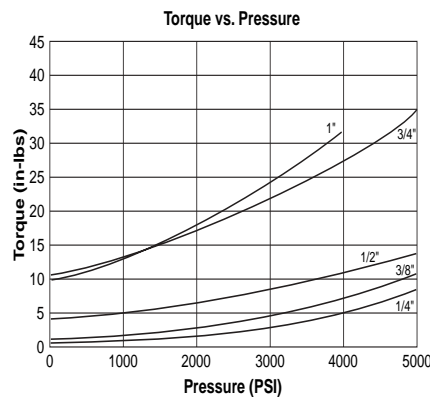
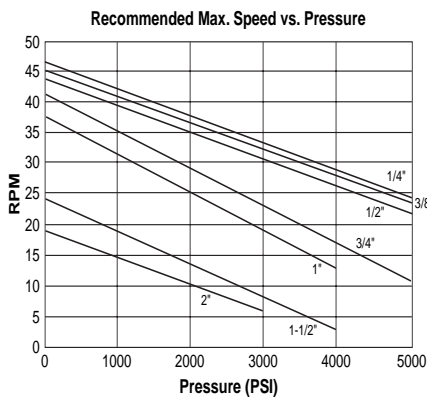

In-Line Swivels

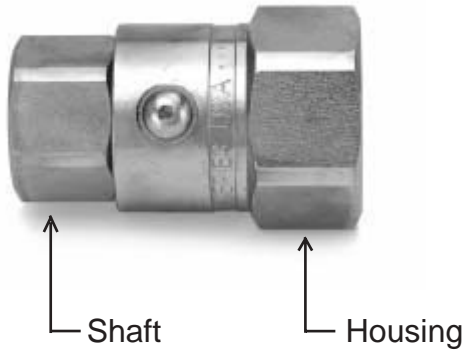

90° Swivels

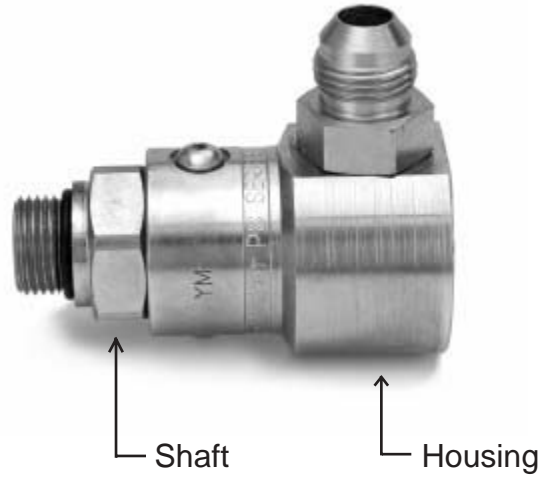

PS Part Number:

PS 16 1 02 02-16-16 Y-

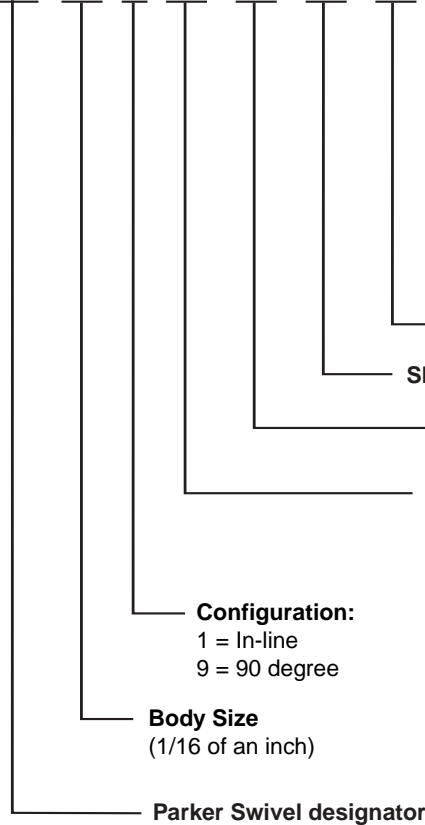

Seal Code:
Blank = Nitrile†
A = Aflas™*
W = Ethylene Propylene
Y = Fluorocarbon
Z = Neoprene
For Perfluoroelastomer Seal Option
Contact the Division.

Housing Port Size (1/16 of an inch)††

Shaft Port Size (1/16 of an inch)††

Shaft Port Configuration:
01 = Male NPTF
02 = Female NPTF
03 = Male JIC 37 Degree
05 = Male SAE O-Ring Straight Thread
10 = Female SAE Straight Thread
JM = Male Seal-Lok

Material and Finish:
Blank = Carbon Steel w/Zinc &
Yellow Chromate Plating (Std.)
NI = Carbon Steel with
Electroless Nickel Plating*
S3 = 303 Stainless Steel
Passivated*
S6 = 316 Stainless Steel
Electropolished*

Housing Port Configuration:
01 = Male NPTF(Non-Standard)*
02 = Female NPTF
03 = Male JIC 37 Degree
05 = Male SAE O-Ring Straight Thread
06 = Female JIC 37 Degree
07 = Female NPSM Pipe Swivel
10 = Female SAE Straight Thread
JM = Male Seal-Lok

Configuration:
1 = In-line
9 = 90 degree

Body Size
(1/16 of an inch)

Parker Swivel designator

*Contact Division for price and delivery
† On -24 and -32 sizes, Polyurethane U-Cup Seal is standard.
†† For -20 Ports, -24 Body is used.

D Swivels

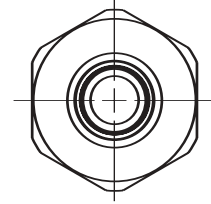
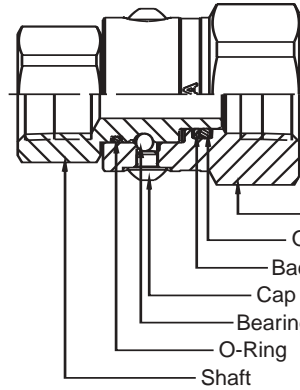

Housing
O-Ring
Back-up Ring
Cap Screw
Bearing
O-Ring
Shaft

Materials Of Construction

- Housing*:.....Carbon Steel
- Shaft*:.....Carbon Steel
- Plating*:.....Zinc with Yellow Chromate
- Bearing*:.....Chrome
- O-Rings*:.....Nitrile
- Back-Up Ring:.....PTFE

* See How-To-Order for optional material, plating, and seals.

Male Pipe - Female Pipe

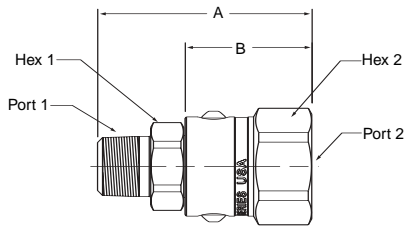

Part Number	A	B	Hex 1	Hex 2	Port 1	Port 2
PS410102-4-4	2.59" 65.8 mm	1.60" 40.6 mm	.75" 19.0 mm	1.19" 30.2 mm	1/4-18 NPTF	1/4-18 NPTF
PS610102-6-6	2.66" 67.5 mm	1.64" 41.7 mm	.88" 22.2 mm	1.31" 33.3 mm	3/8-18 NPTF	3/8-18 NPTF
PS810102-8-8	3.03" 76.8 mm	1.79" 45.5 mm	1.12" 28.6 mm	1.50" 36.5 mm	1/2-14 NPTF	1/2-14 NPTF
PS1210102-12-12	3.10" 78.8 mm	1.85" 47.0 mm	1.38" 35.0 mm	1.69" 42.9 mm	3/4-14 NPTF	3/4-14 NPTF
PS1610102-16-16	3.54" 89.8 mm	2.11" 53.5 mm	1.62" 41.3 mm	1.88" 47.6 mm	1-11 1/2 NPTF	1-11 1/2 NPTF

Male Pipe - Male 37° Flare

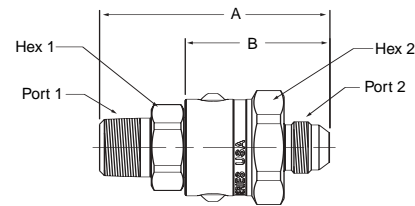

Part Number	A	B	Hex 1	Hex 2	Port 1	Port 2
PS410103-4-4	2.86" 72.6 mm	1.87" 47.5 mm	.75" 19.0 mm	1.19" 30.2 mm	1/4-18 NPTF	7/16-20 UNF-2A
PS610103-6-6	2.92" 74.1 mm	1.90" 48.3 mm	.88" 22.2	1.31" 33.3 mm	3/8-18 NPTF	9/16-18 UNF-2A
PS810103-8-8	3.33" 84.5 mm	2.09" 53.1 mm	1.12" 28.6 mm	1.50" 36.5 mm	1/2-14 NPTF	3/4-16 UNF-2A
PS1210103-12-12	3.55" 90.3 mm	2.30" 58.4 mm	1.38" 35.0 mm	1.69" 42.9 mm	3/4-14 NPTF	1-1/16-12 UN-2A
PS1610103-16-16	3.88" 98.6 mm	2.45" 62.2 mm	1.62" 41.3 mm	1.88" 47.6 mm	1-11 1/2 NPTF	1-5/16-12 UN-2A

Male Pipe - Female 37° Flare

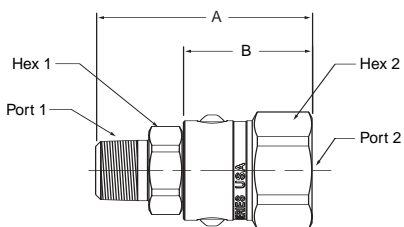

Part Number	A	B	Hex 1	Hex 2	Port 1	Port 2
PS410106-4-4	2.72" 69.1 mm	1.73" 43.9 mm	.75" 19.0 mm	1.19" 30.2 mm	1/4-18 NPTF	7/16-20 UNF-2B
PS610106-6-6	2.77" 70.3 mm	1.75" 44.5 mm	.88" 22.2 mm	1.31" 33.3 mm	3/8-18 NPTF	9/16-18 UNF-2B
PS810106-8-8	3.05" 77.3 mm	1.81" 46.0 mm	1.12" 28.6 mm	1.50" 36.5 mm	1/2-14 NPTF	3/4-16 UNF-2B
PS1210106-12-12	3.27" 83.2 mm	2.02" 51.3 mm	1.38" 35.0 mm	1.69" 42.9 mm	3/4-14 NPTF	1-1/16-12 UN-2B
PS1610106-16-16	3.62" 92.0 mm	2.19" 55.6 mm	1.62" 41.3 mm	1.88" 47.6 mm	1-11 1/2 NPTF	1-5/16-12 UN-2B

Male Pipe - Female SAE Straight Thread

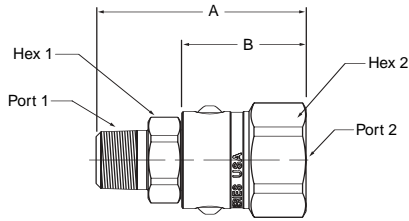

Part Number	A	B	Hex 1	Hex 2	Port 1	Port 2
PS410110-4-4	2.71" 68.8 mm	1.72" 43.7 mm	.75" 19.0 mm	1.19" 30.2 mm	1/4-18 NPTF	7/16-20 UNF-2B
PS610110-6-6	2.74" 69.6 mm	1.72" 43.7 mm	.88" 22.2 mm	1.31" 33.3 mm	3/8-18 NPTF	9/16-18 UNF-2B
PS810110-8-8	3.03" 76.8 mm	1.79" 45.5 mm	1.12" 28.6 mm	1.50" 36.5 mm	1/2-14 NPTF	3/4-16 UNF-2B
PS1210110-12-12	3.33" 84.7 mm	2.08" 52.8 mm	1.38" 35.0 mm	1.69" 42.9 mm	3/4-14 NPTF	1-1/16-12 UN-2B
PS1610110-16-16	3.63" 92.2 mm	2.20" 55.9 mm	1.62" 41.3 mm	1.88" 47.6 mm	1-11 1/2 NPTF	1-5/16-20 UN-2B

Male Pipe - O-Ring Face Seal

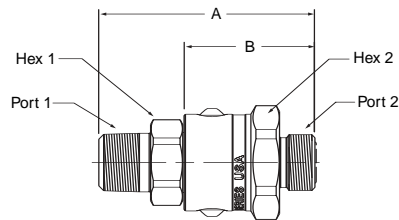

Part Number	A	B	Hex 1	Hex 2	Port 1	Port 2
PS4101JM-4-4	2.74" 69.6 mm	1.75" 44.5 mm	.75" 19.0 mm	1.19" 30.2 mm	1/4-18 NPTF	9/16-18 UNF-2A
PS6101JM-6-6	2.77" 70.3 mm	1.75" 44.5 mm	.88" 22.2 mm	1.31" 33.3 mm	3/8-18 NPTF	11/16-16 UN-2A
PS8101JM-8-8	3.14" 79.6 mm	1.90" 48.3 mm	1.12" 28.6 mm	1.50" 36.5 mm	1/2-14 NPTF	13/16-16 UN-2A
PS12101JM-12-12	3.34" 84.9 mm	2.09" 53.1 mm	1.38" 35.0 mm	1.69" 42.9 mm	3/4-14 NPTF	1-3/16-12 UN-2A
PS16101JM-16-16	3.63" 92.2 mm	2.20" 55.9 mm	1.62" 41.3 mm	1.88" 47.6 mm	1-11 1/2 NPTF	1-7/16-16 UN-2A

Female Pipe - Female Pipe

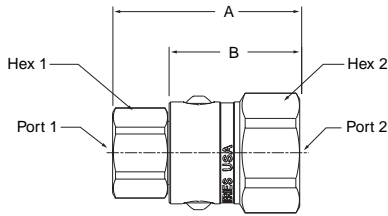

Part Number	A	B	Hex 1	Hex 2	Port 1	Port 2
PS410202-4-4	2.16" 54.9 mm	1.60" 40.6 mm	.75" 19.0 mm	1.19" 30.2 mm	1/4-18 NPTF	1/4-18 NPTF
PS610202-6-6	2.30" 58.3 mm	1.64" 41.7 mm	.88" 22.2 mm	1.31" 33.3 mm	3/8-18 NPTF	3/8-18 NPTF
PS810202-8-8	2.56" 65.0 mm	1.79" 45.5 mm	1.12" 28.6 mm	1.50" 36.5 mm	1/2-14 NPTF	1/2-14 NPTF
PS1210202-12-12	2.88" 73.1 mm	1.85" 47.0 mm	1.38" 35.0 mm	1.69" 42.9 mm	3/4-14 NPTF	3/4-14 NPTF
PS1610202-16-16	3.16" 80.1 mm	2.11" 53.5 mm	1.62" 41.3 mm	1.88" 47.6 mm	1-11 1/2 NPTF	1-11 1/2 NPTF

3 Piece Design

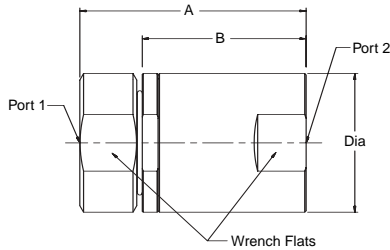

Part Number	A	B	Wrench Flats	Dia.	Port 1	Port 2
PS2410202-20-20	4.67" 118.6 mm	3.38" 85.9 mm	2.63" 66.7 mm	2.88" 73.0 mm	1 1/4-11 1/2 NPTF	1 1/4-11 1/2 NPTF
PS2410202-24-24	4.67" 118.6 mm	3.38" 85.9 mm	2.63" 66.7 mm	2.88" 73.0 mm	1 1/2-11 1/2 NPTF	1 1/2-11 1/2 NPTF
PS3210202-32-32	4.88" 123.9 mm	3.58" 90.8 mm	3.06" 77.6 mm	3.35" 85.1 mm	2-11 1/2 NPTF	2-11 1/2 NPTF

D Swivels

Female Pipe - Male 37° Flare

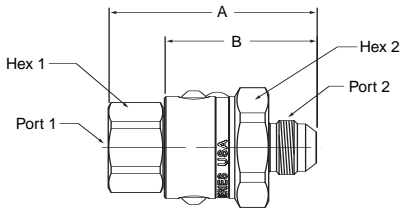

3 Piece Design

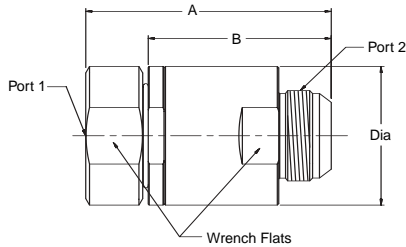

Part Number	A	B	Hex 1	Hex 2	Port 1	Port 2
PS410203-4-4	2.43" 61.7 mm	1.87" 47.5 mm	.75" 19.0 mm	1.19" 30.2 mm	1/4-18 NPTF	7/16-20 UNF-2A
PS610203-6-6	2.56" 65.0 mm	1.90" 48.3 mm	.88" 22.2 mm	1.31" 33.3 mm	3/8-18 NPTF	9/16-18 UNF-2A
PS810203-8-8	2.86" 72.7 mm	2.09" 53.1 mm	1.12" 28.6 mm	1.50" 36.5 mm	1/2-14 NPTF	3/4-16 UNF-2A
PS1210203-12-12	3.33" 84.5 mm	2.30" 58.4 mm	1.38" 35.0 mm	1.69" 42.9 mm	3/4-14 NPTF	1-1/16-12 UN-2A
PS1610203-16-16	3.50" 88.9 mm	2.45" 62.2 mm	1.62" 41.3 mm	1.88" 47.6 mm	1-11 1/2 NPTF	1-5/16-12 UN-2A

Part Number	A	B	Wrench Flats	Dia.	Port 1	Port 2
PS2410203-20-20	5.06" 128.6 mm	3.78" 95.9 mm	2.63" 66.7 mm	2.88" 73.0 mm	1 1/4-11 1/2 NPTF	1 5/8-12 UN-2A
PS2410203-24-24	5.06" 128.6 mm	3.78" 95.9 mm	2.63" 66.7 mm	2.88" 73.0 mm	1 1/2-11 1/2 NPTF	1 7/8-12 UN-2A
PS3210203-32-32	5.58" 141.7 mm	4.28" 108.6 mm	3.06" 77.6 mm	3.35" 85.1 mm	2-11 1/2 NPTF	2 1/2-12 UN-2A

Female Pipe - Female 37° Flare

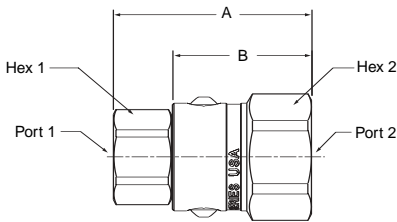

Part Number	A	B	Hex 1	Hex 2	Port 1	Port 2
PS410206-4-4	2.29" 58.2 mm	1.73" 43.9 mm	.75" 19.0 mm	1.19" 30.2 mm	1/4-18 NPTF	7/16-20 UNF-2B
PS610206-6-6	2.41" 61.1 mm	1.75" 44.5 mm	.88" 22.2 mm	1.31" 33.3 mm	3/8-18 NPTF	9/16-18 UNF-2B
PS810206-8-8	2.58" 65.6 mm	1.81" 46.0 mm	1.12" 28.6 mm	1.50" 36.5 mm	1/2-14 NPTF	3/4-16 UNF-2B
PS1210206-12-12	3.05" 77.4 mm	2.02" 51.3 mm	1.38" 35.0 mm	1.69" 42.9 mm	3/4-14 NPTF	1-1/16-12 UN-2B
PS1610206-16-16	3.24" 82.3 mm	2.19" 55.6 mm	1.62" 41.3 mm	1.88" 47.6 mm	1-11 1/2 NPTF	1-5/16-12 UN-2B

Female Pipe - Female SAE Straight Thread

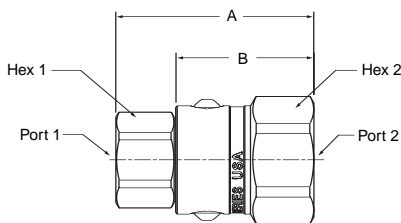

Part Number	A	B	Hex 1	Hex 2	Port 1	Port 2
PS410210-4-4	2.28" 57.9 mm	1.72" 43.7 mm	.75" 19.0 mm	1.19" 30.2 mm	1/4-18 NPTF	7/16-20 UNF-2B
PS610210-6-6	2.38" 60.4 mm	1.72" 43.7 mm	.88" 22.2 mm	1.31" 33.3 mm	3/8-18 NPTF	9/16-18 UNF-2B
PS810210-8-8	2.56" 65.0 mm	1.79" 45.5 mm	1.12" 28.6 mm	1.50" 36.5 mm	1/2-14 NPTF	3/4-16 UNF-2B
PS1210210-12-12	3.11" 78.9 mm	2.08" 52.8 mm	1.38" 35.0 mm	1.69" 42.9 mm	3/4-14 NPTF	1-1/16-12 UN-2B
PS1610210-16-16	3.25" 82.6 mm	2.20" 55.9 mm	1.62" 41.3 mm	1.88" 47.6 mm	1-11 1/2 NPTF	1-5/16-20 UN-2B

Female Pipe - O-Ring Face Seal

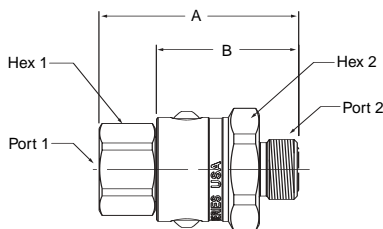

Part Number	A	B	Hex 1	Hex 2	Port 1	Port 2
PS4102JM-4-4	2.31" 58.7 mm	1.75" 44.5 mm	.75" 19.0 mm	1.19" 30.2 mm	1/4-18 NPTF	9/16-18 UNF-2A
PS6102JM-6-6	2.41" 61.1 mm	1.75" 44.5 mm	.88" 22.2 mm	1.31" 33.3 mm	3/8-18 NPTF	11/16-16 UN-2A
PS8102JM-8-8	2.67" 67.9 mm	1.90" 48.3 mm	1.12" 28.6 mm	1.50" 36.5 mm	1/2-14 NPTF	13/16-16 UN-2A
PS12102JM-12-12	3.12" 79.2 mm	2.09" 53.1 mm	1.38" 35.0 mm	1.69" 42.9 mm	3/4-14 NPTF	1-3/16-12 UN-2A
PS16102JM-16-16	3.25" 82.6 mm	2.20" 55.9 mm	1.62" 41.3 mm	1.88" 47.6 mm	1-11 1/2 NPTF	1-7/16-12 UN-2A

Male 37° Flare - Female Pipe

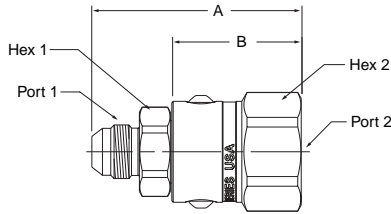

3 Piece Design

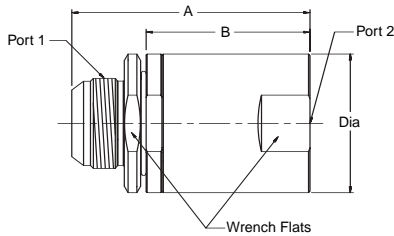

Part Number	A	B	Hex 1	Hex 2	Port 1	Port 2
PS410302-4-4	2.59" 65.8 mm	1.60" 40.6 mm	.75" 19.0 mm	1.19" 30.2 mm	7/16-20 UNF-2A	1/4-18 NPTF
PS610302-6-6	2.66" 67.5 mm	1.64" 41.7 mm	.88" 22.2 mm	1.31" 33.3 mm	9/16-18 UNF-2A	3/8-18 NPTF
PS810302-8-8	2.89" 73.5 mm	1.79" 45.5 mm	1.12" 28.6 mm	1.50" 36.5 mm	3/4-16 UNF-2A	1/2-14 NPTF
PS1210302-12-12	3.21" 81.5 mm	1.85" 47.0 mm	1.38" 35.0 mm	1.69" 42.9 mm	1-1/16-12 UN-2A	3/4-14 NPTF
PS1610302-16-16	3.54" 89.8 mm	2.11" 53.5 mm	1.62" 41.3 mm	1.88" 47.6 mm	1-5/16-12 UN-2A	1-11 1/2 NPTF

Part Number	A	B	Wrench Flats	Dia.	Port 1	Port 2
PS2410302-20-20	4.91" 124.8 mm	3.38" 85.9 mm	2.63" 66.7 mm	2.88" 73.0 mm	1 5/8-12 UN-2A	1 1/4-11 1/2 NPTF
PS2410302-24-24	4.91" 124.8 mm	3.38" 85.9 mm	2.63" 66.7 mm	2.88" 73.0 mm	1 7/8-12 UN-2A	1 1/2-11 1/2 NPTF
PS3210302-32-32	5.50" 139.8 mm	3.58" 90.8 mm	3.06" 77.6 mm	3.35" 85.1 mm	2 1/2-12 UN-2A	2-11 1/2 NPTF

Male 37° Flare - Male 37° Flare

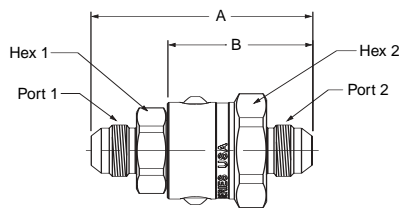

3 Piece Design

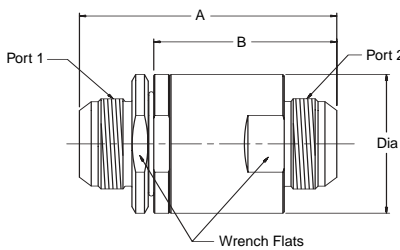

Part Number	A	B	Hex 1	Hex 2	Port 1	Port 2
PS410303-4-4	2.86" 72.6 mm	1.87" 47.5 mm	.75" 19.0 mm	1.19" 30.2 mm	7/16-20 UNF-2A	7/16-20 UNF-2A
PS610303-6-6	2.92" 74.1 mm	1.90" 48.3 mm	.88" 22.2 mm	1.31" 33.3 mm	9/16-18 UNF-2A	9/16-18 UNF-2A
PS810303-8-8	3.19" 81.1 mm	2.09" 53.1 mm	1.12" 28.6 mm	1.50" 36.5 mm	3/4-16 UNF-2A	3/4-16 UNF-2A
PS810303-10-10	3.39" 86.2 mm	2.19" 55.6 mm	1.12" 28.6 mm	1.50" 36.5 mm	7/8-14 UNF-2A	7/8-14 UNF-2A
PS1210303-12-12	3.66" 92.9 mm	2.30" 58.4 mm	1.38" 35.0 mm	1.69" 42.9 mm	1-1/16-12 UN-2A	1-1/16-12 UN-2A
PS1610303-16-16	3.88" 98.6 mm	2.45" 62.2 mm	1.62" 41.3 mm	1.88" 47.6 mm	1-5/16-12 UN-2A	1-5/16-12 UN-2A

Part Number	A	B	Wrench Flats	Dia.	Port 1	Port 2
PS2410303-20-20	5.31" 134.8 mm	3.78" 95.9 mm	2.63" 66.7 mm	2.88" 73.0 mm	1 5/8-12 UN-2A	1 5/8-12 UN-2A
PS2410303-24-24	5.31" 134.8 mm	3.78" 95.9 mm	2.63" 66.7 mm	2.88" 73.0 mm	1 7/8-12 UN-2A	1 7/8-12 UN-2A
PS3210303-32-32	6.20" 157.5 mm	4.28" 108.6 mm	3.06" 77.6 mm	3.35" 85.1 mm	2 1/2-12 UN-2A	2 1/2-12 UN-2A

Male 37° Flare - Female 37° Flare

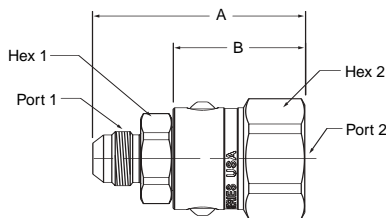

Part Number	A	B	Hex 1	Hex 2	Port 1	Port 2
PS410306-4-4	2.72" 69.1 mm	1.73" 43.9 mm	.75" 19.0 mm	1.19" 30.2 mm	7/16-20 UNF-2A	7/16-20 UNF-2B
PS610306-6-6	2.77" 70.3 mm	1.75" 44.5 mm	.88" 22.2 mm	1.31" 33.3 mm	9/16-18 UNF-2A	9/16-18 UNF-2B
PS810306-8-8	2.91" 74.0 mm	1.81" 46.0 mm	1.12" 28.6 mm	1.50" 36.5 mm	3/4-16 UNF-2A	3/4-16 UNF-2B
PS1210306-12-12	3.38" 85.8 mm	2.02" 51.3 mm	1.38" 35.0 mm	1.69" 42.9 mm	1-1/16-12 UN-2A	1-1/16-12 UN-2B
PS1610306-16-16	3.62" 92.0 mm	2.19" 55.6 mm	1.62" 41.3 mm	1.88" 47.6 mm	1-5/16-12 UN-2A	1-5/16-12 UN-2B

D Swivels

Male 37° Flare - Female SAE Straight Thread

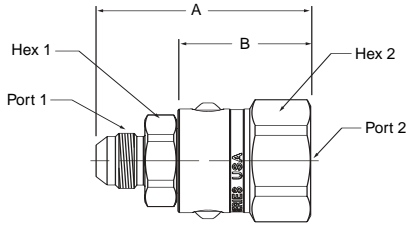

3 Piece Design

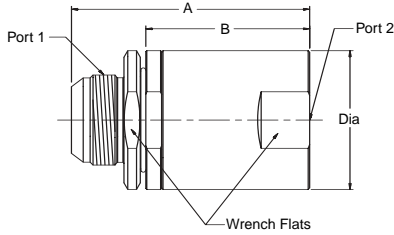

Part Number	A	B	Hex 1	Hex 2	Port 1	Port 2
PS410310-4-4	2.71" 68.8 mm	1.72" 43.7 mm	.75" 19.0 mm	1.19" 30.2 mm	7/16-20 UNF-2A	7/16-20 UNF-2B
PS610310-6-6	2.74" 69.6 mm	1.72" 43.7 mm	.88" 22.2 mm	1.31" 33.3 mm	9/16-18 UNF-2A	9/16-18 UNF-2B
PS810310-8-8	2.89" 73.5 mm	1.79" 45.5 mm	1.12" 28.6 mm	1.50" 36.5 mm	3/4-16 UNF-2A	3/4-16 UNF-2B
PS1210310-12-12	3.44" 87.3 mm	2.08" 52.8 mm	1.38" 35.0 mm	1.69" 42.9 mm	1-1/16-12 UN-2A	1-1/16-12 UN-2B
PS1610310-16-16	3.63" 92.2 mm	2.20" 55.9 mm	1.62" 41.3 mm	1.88" 47.6 mm	1-5/16-12 UN-2A	1-5/16-12 UN-2B

Part Number	A	B	C	D	Dia.	Wrench Flats	Port 1	Port 2
PS2410310-20-20	6.16" 150.2 mm	4.63" 117.5 mm	3.43" 87.0 mm	1.27" 32.3 mm	2.63" 66.7 mm	3.36" 85.2 mm	1 5/8-12 UN-2A	1 5/8-12 UN-2B
PS2410310-24-24	6.16" 150.2 mm	4.63" 117.5 mm	3.43" 87.0 mm	1.27" 32.3 mm	2.63" 66.7 mm	3.36" 85.2 mm	17/8-12 UN-2A	17/8-12 UN-2B
PS3210310-32-32	7.38" 187.4 mm	5.45" 138.4 mm	3.93" 99.7 mm	1.52" 38.5 mm	3.06" 77.6 mm	4.19" 106.4 mm	2 1/2-12 UN-2A	2-1/2-12 UN-2B

Male 37° Flare - O-Ring Face Seal

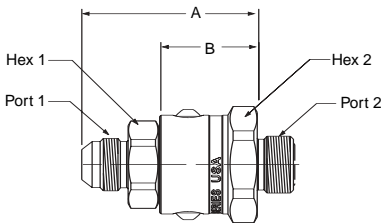

Part Number	A	B	Hex 1	Hex 2	Port 1	Port 2
PS4103JM-4-4	2.74" 69.6 mm	1.75" 44.5 mm	.75" 19.0 mm	1.19" 30.2 mm	7/16-20 UNF-2A	9/16-18 UNF-2A
PS6103JM-6-6	2.77" 70.3 mm	1.75" 44.5 mm	.88" 22.2 mm	1.31" 33.3 mm	9/16-18 UNF-2A	11/16-18 UNF-2A
PS8103JM-8-8	3.00" 76.3 mm	1.90" 48.3 mm	1.12" 28.6 mm	1.50" 36.5 mm	3/4-16 UNF-2A	13/16-16 UNF-2A
PS8103JM-10-10	3.20" 81.2 mm	1.99" 50.5 mm	1.12" 28.6 mm	1.50" 36.5 mm	7/8-14 UNF-2A	7/8-14 UNF-2A
PS12103JM-12-12	3.45" 87.6 mm	2.09" 53.1 mm	1.38" 35.0 mm	1.69" 42.9 mm	1-1/16-12 UN-2A	1-3/16-12 UN-2A
PS16103JM-16-16	3.63" 92.2 mm	2.20" 55.9 mm	1.62" 41.3 mm	1.88" 47.6 mm	1-5/16-12 UN-2A	1-7/16-12 UN-2A

Male SAE O-Ring Straight Thread - Female Pipe

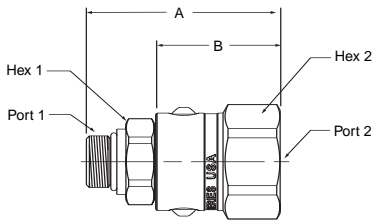

Part Number	A	B	Hex 1	Hex 2	Port 1	Port 2
PS410502-4-4	2.44" 62.1 mm	1.60" 40.6 mm	.75" 19.0 mm	1.19" 30.2 mm	7/16-20 UNF-2A	1/4-18 NPTF
PS610502-6-6	2.48" 63.0 mm	1.64" 41.7 mm	.88" 22.2 mm	1.31" 33.3 mm	9/16-18 UNF-2A	3/8-18 NPTF
PS810502-8-8	2.79" 70.8 mm	1.79" 45.5 mm	1.12" 28.6 mm	1.50" 36.5 mm	3/4-16 UN-2A	1/2-14 NPTF
PS1210502-12-12	3.02" 76.7 mm	1.85" 47.0 mm	1.38" 35.0 mm	1.69" 42.9 mm	1-1/16-12 UN-2A	3/4-14 NPTF
PS1610502-16-16	3.31" 84.1 mm	2.11" 53.5 mm	1.62" 41.3 mm	1.88" 47.6 mm	1-5/16-12 UN-2A	1-11/2 NPTF

Male SAE O-Ring Straight Thread - Male 37° Flare

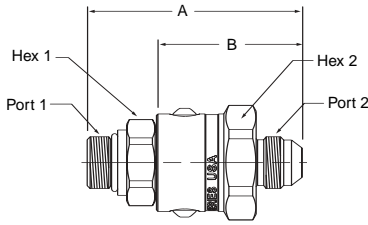

Part Number	A	B	Hex 1	Hex 2	Port 1	Port 2
PS410503-4-4	2.71" 68.9 mm	1.87" 47.5 mm	.75" 19.0 mm	1.19" 30.2 mm	7/16-20 UNF-2A	7/16-20 UNF-2A
PS610503-6-6	2.74" 69.6 mm	1.90" 48.3 mm	.88" 22.2 mm	1.31" 33.3 mm	9/16-18 UNF-2A	9/16-18 UNF-2A
PS810503-8-8	3.09" 78.4 mm	2.09" 53.1 mm	1.12" 28.6 mm	1.50" 36.5 mm	3/4-16 UNF-2A	3/4-16 UNF-2A
PS810503-10-10	3.25" 82.5 mm	2.19" 55.6 mm	1.12" 28.6 mm	1.50" 36.5 mm	7/8-14 UNF-2A	7/8-14 UNF-2A
PS1210503-12-12	3.47" 88.2 mm	2.30" 58.4 mm	1.38" 35.0 mm	1.69" 42.9 mm	1-1/16-12 UN-2A	1-1/16-12 UN-2A
PS1610503-16-16	3.66" 92.9 mm	2.45" 62.2 mm	1.62" 41.3 mm	1.88" 47.6 mm	1-5/16-12 UN-2A	1-5/16-12 UN-2A

Male SAE O-Ring Straight Thread - Female 37° Flare

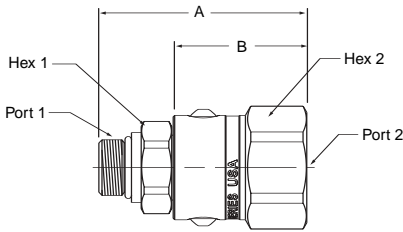

Part Number	A	B	Hex 1	Hex 2	Port 1	Port 2
PS410506-4-4	2.57" 65.4 mm	1.73" 43.9 mm	.75" 19.0 mm	1.19" 30.2 mm	7/16-20 UNF-2A	7/16-20 UNF-2B
PS610506-6-6	2.59" 65.8 mm	1.75" 44.5 mm	.88" 22.2 mm	1.31" 33.3 mm	9/16-18 UNF-2A	9/16-18 UNF-2B
PS810506-8-8	2.81" 71.3 mm	1.81" 46.0 mm	1.12" 28.6 mm	1.50" 36.5 mm	3/4-16 UNF-2A	3/4-16 UNF-2B
PS1210506-12-12	3.19" 81.1 mm	2.02" 51.3 mm	1.38" 35.0 mm	1.69" 42.9 mm	1-1/16-12 UN-2A	1-1/16-12 UN-2B
PS1610506-16-16	3.40" 86.3 mm	2.19" 55.6 mm	1.62" 41.3 mm	1.88" 47.6 mm	1-5/16-12 UN-2A	1-5/16-12 UN-2B

Male SAE O-Ring Straight Thread - Female SAE Straight Thread

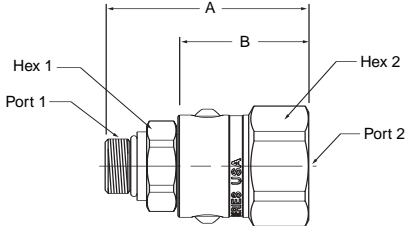

Part Number	A	B	Hex 1	Hex 2	Port 1	Port 2
PS410510-4-4	2.56" 65.0 mm	1.72" 43.7 mm	.75" 19.0 mm	1.19" 30.2 mm	7/16-20 UNF-2A	7/16-20 UNF-2B
PS610510-6-6	2.56" 65.0 mm	1.72" 43.7 mm	.88" 22.2 mm	1.31" 33.3 mm	9/16-18 UNF-2A	9/16-18 UNF-2B
PS810510-8-8	2.79" 70.8 mm	1.79" 45.5 mm	1.12" 28.6 mm	1.50" 36.5 mm	3/4-16 UNF-2A	3/4-16 UNF-2B
PS1210510-12-12	3.25" 82.6 mm	2.08" 52.8 mm	1.38" 35.0 mm	1.69" 42.9 mm	1-1/16-12 UN-2A	1-1/16-12 UN-2B
PS1610510-16-16	3.41" 86.5 mm	2.20" 55.9 mm	1.62" 41.3 mm	1.88" 47.6 mm	1-5/16-12 UN-2A	1-5/16-12 UN-2B

Male SAE O-Ring Straight Thread - O-Ring Face Seal

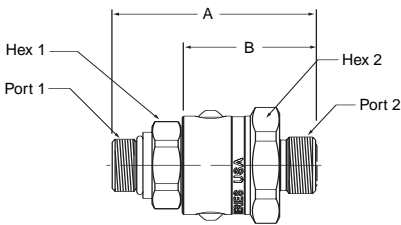

Part Number	A	B	Hex 1	Hex 2	Port 1	Port 2
PS4105JM-4-4	2.59" 65.8 mm	1.75" 44.5 mm	.75" 19.0 mm	1.19" 30.2 mm	7/16-20 UNF-2A	9/16-18 UNF-2A
PS6105JM-6-6	2.59" 65.8 mm	1.75" 44.5 mm	.88" 22.2 mm	1.31" 33.3 mm	9/16-18 UNF-2A	11/16-16 UNF-2A
PS8105JM-8-8	2.90" 73.6 mm	1.90" 48.3 mm	1.12" 28.6 mm	1.50" 36.5 mm	3/4-16 UNF-2A	13/16-16 UNF-2A
PS8105JM-10-10	3.05" 77.4 mm	1.99" 50.5 mm	1.12" 28.6 mm	1.50" 36.5 mm	7/8-14 UNF-2A	1-14 UNF-2A
PS12105JM-12-12	3.26" 82.8 mm	2.09" 53.1 mm	1.38" 35.0 mm	1.69" 42.9 mm	1-1/16-12 UN-2A	1-3/16-12 UN-2A
PS16105JM-16-16	3.41" 86.5 mm	2.20" 55.9 mm	1.62" 41.3 mm	1.88" 47.6 mm	1-5/16-12 UN-2A	1-7/16-12 UN-2A

Female SAE Straight Thread - Female Pipe

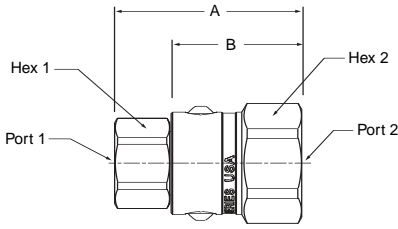

Part Number	A	B	Hex 1	Hex 2	Port 1	Port 2
PS411002-4-4	2.16" 55.0 mm	1.60" 40.6 mm	.75" 19.0 mm	1.19" 30.2 mm	7/16-20 UNF-2B	1/4-18 NPTF
PS611002-6-6	2.30" 58.3 mm	1.64" 41.7 mm	.88" 22.2 mm	1.31" 33.3 mm	9/16-18 UNF-2B	3/8-18 NPTF
PS811002-8-8	2.56" 65.0 mm	1.79" 45.5 mm	1.12" 28.6 mm	1.50" 36.5 mm	3/4-16 UNF-2B	1/2-14 NPTF
PS1211002-12-12	2.88" 73.1 mm	1.85" 47.0 mm	1.38" 35.0 mm	1.69" 42.9 mm	1-1/16-12 UN-2B	3/4-14 NPTF
PS1611002-16-16	3.16" 80.1 mm	2.11" 53.5 mm	1.62" 41.3 mm	1.88" 47.6 mm	1-5/16-12 UN-2B	1-11 1/2 NPTF

Female SAE Straight Thread - Male 37° Flare

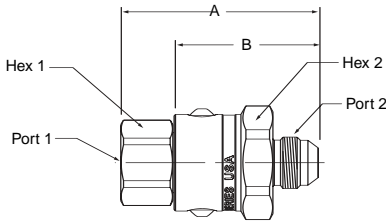

Part Number	A	B	Hex 1	Hex 2	Port 1	Port 2
PS411003-4-4	2.43" 61.8 mm	1.87" 47.5 mm	.75" 19.0 mm	1.19" 30.2 mm	7/16-20 UNF-2B	7/16-20 UNF-2A
PS611003-6-6	2.56" 65.0 mm	1.90" 48.3 mm	.88" 22.2 mm	1.31" 33.3 mm	9/16-18 UNF-2B	9/16-18 UNF-2A
PS811003-8-8	2.86" 72.7 mm	2.09" 53.1 mm	1.12" 28.6 mm	1.50" 36.5 mm	3/4-16 UNF-2B	3/4-16 UNF-2A
PS1211003-12-12	3.33" 84.5 mm	2.30" 58.4 mm	1.38" 35.0 mm	1.69" 42.9 mm	1-1/16-12 UN-2B	1-1/16-12 UN-2A
PS1611003-16-16	3.50" 88.9 mm	2.45" 62.2 mm	1.62" 41.3 mm	1.88" 47.6 mm	1-5/16-12 UN-2B	1-5/16-12 UN-2A

Female SAE Straight Thread - Female 37° Flare

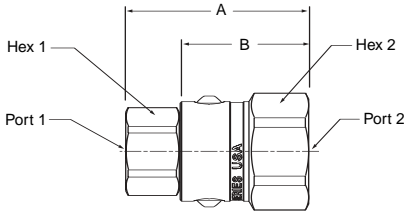

Part Number	A	B	Hex 1	Hex 2	Port 1	Port 2
PS411006-4-4	2.29" 58.3 mm	1.73" 43.9 mm	.75" 19.0 mm	1.19" 30.2 mm	7/16-20 UNF-2B	7/16-20 UNF-2B
PS611006-6-6	2.41" 61.1 mm	1.75" 44.5 mm	.88" 22.2 mm	1.31" 33.3 mm	9/16-18 UNF-2B	9/16-18 UNF-2B
PS811006-8-8	2.58" 65.6 mm	1.81" 46.0 mm	1.12" 28.6 mm	1.50" 36.5 mm	3/4-16 UNF-2B	3/4-16 UNF-2B
PS1211006-12-12	3.05" 77.4 mm	2.02" 51.3 mm	1.38" 35.0 mm	1.69" 42.9 mm	1-1/16-12 UN-2B	1-1/16-12 UN-2B
PS1611006-16-16	3.24" 82.3 mm	2.19" 55.6 mm	1.62" 41.3 mm	1.88" 47.6 mm	1-5/16-12 UN-2B	1-5/16-12 UN-2B

Female SAE Straight Thread - Female SAE Straight Thread

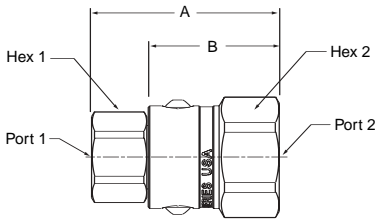

Part Number	A	B	Hex 1	Hex 2	Port 1	Port 2
PS411010-4-4	2.28" 58.0 mm	1.72" 43.7 mm	.75" 19.0 mm	1.19" 30.2 mm	7/16-20 UNF-2B	7/16-20 UNF-2B
PS611010-6-6	2.38" 60.4 mm	1.72" 43.7 mm	.88" 22.2 mm	1.31" 33.3 mm	9/16-18 UNF-2B	9/16-18 UNF-2B
PS811010-8-8	2.56" 65.0 mm	1.79" 45.5 mm	1.12" 28.6 mm	1.50" 36.5 mm	3/4-16 UNF-2B	3/4-16 UNF-2B
PS1211010-12-12	3.11" 78.9 mm	2.08" 52.8 mm	1.38" 35.0 mm	1.69" 42.9 mm	1-1/16-12 UN-2B	1-1/16-12 UN-2B
PS1611010-16-16	3.25" 82.6 mm	2.20" 55.9 mm	1.62" 41.3 mm	1.88" 47.6 mm	1-5/16-12 UN-2B	1-5/16-12 UN-2B

3 Piece Design

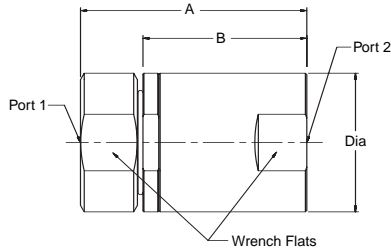

Part Number	A	B	C	D	Wrench Flats	Dia.	Port 1	Port 2
PS2411010-20-20	5.91" 150.2 mm	4.63" 117.5 mm	3.43" 87.0 mm	1.27" 32.3 mm	2.63" 66.7 mm	3.36" 85.2 mm	1 5/8-12 UN-2B	1 5/8-12 UN-2B
PS2411010-24-24	5.91" 150.2 mm	4.63" 117.5 mm	3.43" 87.0 mm	1.27" 32.3 mm	2.63" 66.7 mm	3.36" 85.2 mm	1 7/8-12 UN-2B	1 7/8-12 UN-2B
PS3211010-32-32	6.83" 173.6 mm	5.45" 138.4 mm	3.93" 99.7 mm	1.52" 38.5 mm	3.06" 77.6 mm	4.19" 106.4 mm	2 1/2-12 UN-2B	2-1/2-12 UN-2B

D Swivels

Female SAE Straight Thread - O-Ring Face Seal

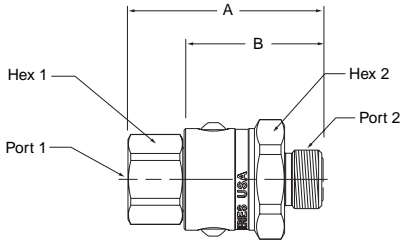

Part Number	A	B	Hex 1	Hex 2	Port 1	Port 2
PS4110JM-4-4	2.31" 58.8 mm	1.75" 44.5 mm	.75" 19.0 mm	1.19" 30.2 mm	7/16-20 UNF-2B	9/16-18 UNF-2A
PS6110JM-6-6	2.41" 61.1 mm	1.75" 44.5 mm	.88" 22.2 mm	1.31" 33.3 mm	9/16-18 UNF-2B	11/16-16 UN-2A
PS8110JM-8-8	2.67" 67.9 mm	1.90" 48.3 mm	1.12" 28.6 mm	1.50" 36.5 mm	3/4-16 UNF-2B	13/16-16 UN-2A
PS12110JM-12-12	3.12" 79.2 mm	2.09" 53.1 mm	1.38" 35.0 mm	1.69" 42.9 mm	1-1/16-12 UN-2B	1-3/16-12 UN-2A
PS16110JM-16-16	3.25" 82.6 mm	2.20" 55.9 mm	1.62" 41.3 mm	1.88" 47.6 mm	1-5/16-12 UN-2B	1-7/16-12 UN-2A

O-Ring Face Seal - Female Pipe

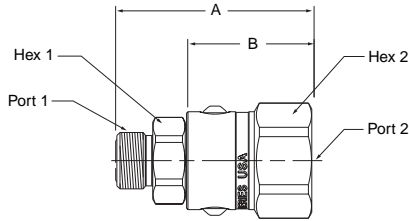

Part Number	A	B	Hex 1	Hex 2	Port 1	Port 2
PS41JM02-4-4	2.44" 62.1 mm	1.60" 40.6 mm	.75" 19.0 mm	1.19" 30.2 mm	9/16-18 UNF-2A	1/4-18 NPTF
PS61JM02-6-6	2.48" 63.0 mm	1.64" 41.7 mm	.88" 22.2 mm	1.31" 33.3 mm	11/16-16 UN-2A	3/8-18 NPTF
PS81JM02-8-8	2.79" 70.8 mm	1.79" 45.5 mm	1.12" 28.6 mm	1.50" 36.5 mm	13/16-16 UN-2A	1/2-14 NPTF
PS121JM02-12-12	3.02" 76.7 mm	1.85" 47.0 mm	1.38" 35.0 mm	1.69" 42.9 mm	1-3/16-12 UN-2A	3/4-14 NPTF
PS161JM02-16-16	3.31" 84.1 mm	2.11" 53.5 mm	1.62" 41.3 mm	1.88" 47.6 mm	1-7/16-12 UN-2A	1-11/16-12 NPTF

O-Ring Face Seal - Male 37° Flare

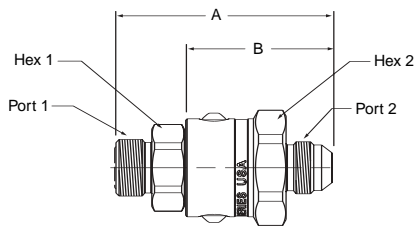

Part Number	A	B	Hex 1	Hex 2	Port 1	Port 2
PS41JM03-4-4	2.71" 68.9 mm	1.87" 47.5 mm	.75" 19.0 mm	1.19" 30.2 mm	9/16-18 UN-2A	7/16-20 UN-2A
PS61JM03-6-6	2.74" 69.6 mm	1.90" 48.3 mm	.88" 22.2 mm	1.31" 33.3 mm	11/16-16 UN-2A	9/16-18 UN-2A
PS81JM03-8-8	3.09" 78.4 mm	2.09" 53.1 mm	1.12" 28.6 mm	1.50" 36.5 mm	13/16-16 UN-2A	3/4-16 UN-2A
PS81JM03-10-10	3.29" 83.7 mm	2.19" 55.6 mm	1.12" 28.6 mm	1.50" 36.5 mm	1-14 UN-2A	7/8-14 UN-2A
PS121JM03-12-12	3.47" 88.2 mm	2.30" 58.4 mm	1.38" 35.0 mm	1.69" 42.9 mm	1-3/16-12 UNF-2A	1-1/16-12 UNF-2A
PS161JM03-16-16	3.66" 92.9 mm	2.45" 62.2 mm	1.62" 41.3 mm	1.88" 47.6 mm	1-7/16-12 UNF-2A	1-5/16-12 UNF-2A

O-Ring Face Seal - Female 37° Flare

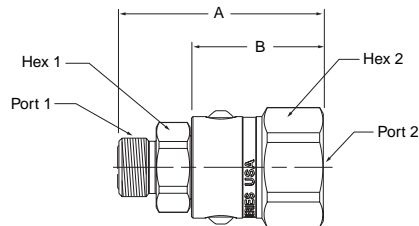

Part Number	A	B	Hex 1	Hex 2	Port 1	Port 2
PS41JM06-4-4	2.57" 65.4 mm	1.73" 43.9 mm	.75" 19.0 mm	1.19" 30.2 mm	9/16-18 UNF-2A	7/16-20 UNF-2B
PS61JM06-6-6	2.59" 65.8 mm	1.75" 44.5 mm	.88" 22.2 mm	1.31" 33.3 mm	11/16-16 UNF-2A	9/16-18 UNF-2B
PS81JM06-8-8	2.81" 71.3 mm	1.81" 46.0 mm	1.12" 28.6 mm	1.44" 36.5 mm	13/16-16 UNF-2A	3/4-16 UNF-2B
PS121JM06-12-12	3.19" 81.1 mm	2.02" 51.3 mm	1.38" 35.0 mm	1.69" 42.9 mm	1-3/16-12 UN-2A	1-1/16-12 UN-2B
PS161JM06-16-16	3.40" 86.3 mm	2.19" 55.6 mm	1.62" 41.3 mm	1.88" 47.6 mm	1-7/16-12 UN-2A	1-5/16-12 UN-2B

D Swivels

O-Ring Face Seal - Female SAE Straight Thread

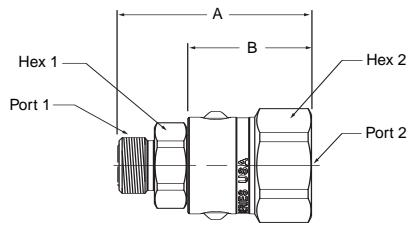

Part Number	A	B	Hex 1	Hex 2	Port 1	Port 2
PS41JM10-4-4	2.56" 65.0 mm	1.72" 43.7 mm	.75" 19.0 mm	1.19" 30.2 mm	9/16-18 UNF-2A	7/16-20 UNF-2B
PS61JM10-6-6	2.56" 65.0 mm	1.72" 43.7 mm	.88" 22.2 mm	1.31" 33.3 mm	11/16-16 UN-2A	9/16-18 UNF-2B
PS81JM10-8-8	2.79" 70.8 mm	1.79" 45.5 mm	1.12" 28.6 mm	1.50" 36.5 mm	13/16-16 UN-2A	3/4-16 UNF-2B
PS121JM10-12-12	3.25" 82.6 mm	2.08" 52.8 mm	1.38" 35.0 mm	1.69" 42.9 mm	1-3/16-12 UN-2A	1-1/16-12 UN-2B
PS161JM10-16-16	3.41" 86.5 mm	2.20" 55.9 mm	1.62" 41.3 mm	1.88" 47.6 mm	1-7/16-12 UN-2A	1-5/16-12 UN-2B

O-Ring Face Seal - O-Ring Face Seal

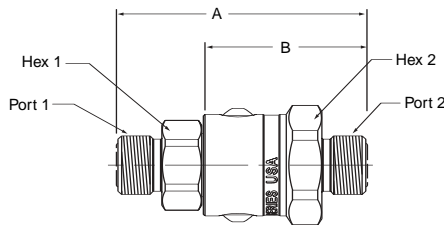

Part Number	A	B	Hex 1	Hex 2	Port 1	Port 2
PS41JMJM-4-4	2.59" 65.8 mm	1.75" 44.5 mm	.75" 19.0 mm	1.19" 30.2 mm	9/16-18 UNF-2A	9/16-18 UNF-2A
PS61JMJM-6-6	2.59" 65.8 mm	1.75" 44.5 mm	.88" 22.2 mm	1.31" 33.3 mm	11/16-16 UN-2A	11/16-16 UN-2A
PS81JMJM-8-8	2.90" 73.6 mm	1.90" 48.3 mm	1.12" 28.6 mm	1.50" 36.5 mm	13/16-16 UN-2A	13/16-16 UN-2A
PS121JMJM-12-12	3.26" 82.8 mm	2.09" 53.1 mm	1.38" 35.0 mm	1.69" 42.9 mm	1-3/16-12 UN-2A	1-3/16-12 UN-2A
PS161JMJM-16-16	3.41" 86.5 mm	2.20" 55.9 mm	1.62" 41.3 mm	1.88" 47.6 mm	1-7/16-12 UN-2A	1-7/16-12 UN-2A

D Swivels

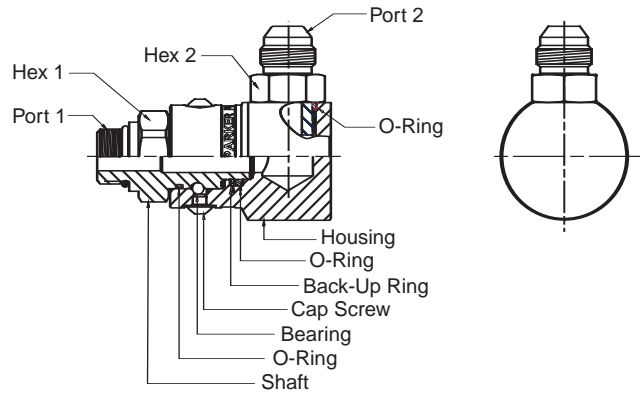

Materials Of Construction

- Housing*:Carbon Steel
- Shaft*:Carbon Steel
- Plating*:Zinc with Yellow Chromate
- Bearing*:Chrome
- O-Rings*:Nitrile
- Back-Up Ring:PTFE

* See How-To-Order for optional material plating and seals.

Male Pipe - Female Pipe

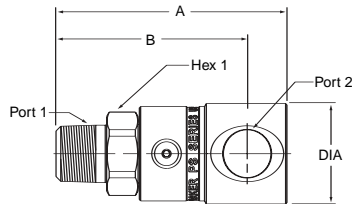

Part Number	A	B	Dia.	Hex 1	Port 1	Port 2
PS490102-4-4	2.85" 72.3 mm	2.44" 62.0 mm	1.20" 30.5 mm	.75" 19.0 mm	1/4-18 NPTF	1/4-18 NPTF
PS690102-6-6	3.05" 77.4 mm	2.54" 64.4 mm	1.29" 32.8 mm	.88" 22.2 mm	3/8-18 NPTF	3/8-18 NPTF
PS890102-8-8	3.43" 87.0 mm	2.84" 72.0 mm	1.49" 37.8 mm	1.12" 28.6 mm	1/2-14 NPTF	1/2-14 NPTF
PS1290102-12-12	3.66" 93.0 mm	3.00" 76.1 mm	1.76" 44.6 mm	1.38" 35.0 mm	3/4-14 NPTF	3/4-14 NPTF
PS1690102-16-16	4.41" 112.0 mm	3.54" 90.0 mm	2.16" 54.9 mm	1.62" 41.3 mm	1-11 1/2 NPTF	1-11 1/2 NPTF

Male Pipe - Male 37° Flare

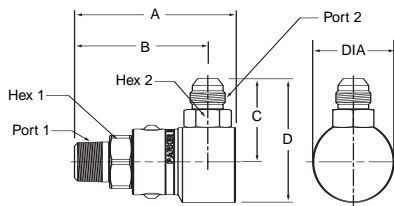

Part Number	A	B	C	D	Dia	Hex 1	Hex 2	Port 1	Port 2
PS490103-4-4	2.85" 72.3 mm	2.44" 62.0 mm	1.39" 35.2 mm	1.99" 50.5 mm	1.20" 30.5 mm	.75" 19.0 mm	.56" 14.3 mm	1/4-18 NPTF	7/16-20 UNF-2A
PS690103-6-6	3.05" 77.4 mm	2.54" 64.4 mm	1.44" 36.6 mm	2.09" 53.0 mm	1.29" 32.8 mm	.88" 22.2 mm	.69" 17.5 mm	3/8-18 NPTF	9/16-18 UNF-2A
PS890103-8-8	3.43" 87.0 mm	2.84" 72.0 mm	1.78" 45.1 mm	2.64" 67.1 mm	1.73" 44.0 mm	1.12" 28.6 mm	.88" 22.2 mm	1/2-14 NPTF	3/4-16 UNF-2A
PS1290103-12-12	3.66" 93.0 mm	3.00" 76.1 mm	2.24" 56.9 mm	3.86" 85.3 mm	2.17" 55.2 mm	1.38" 35.0 mm	1.25" 31.8 mm	3/4-14 NPTF	1-1/16-12 UN-2A
PS1690103-16-16	4.41" 112.0 mm	3.54" 90.0 mm	2.42" 61.3 mm	3.66" 92.9 mm	2.48" 63.0 mm	1.62" 41.3 mm	1.50" 38.1 mm	1-11 1/2 NPTF	1-5/16-12 UN-2A

D Swivels

Male Pipe - Male SAE O-Ring Straight Thread

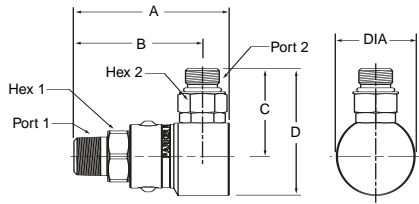

Part Number	A	B	C	D	Dia.	Hex 1	Hex 2	Port 1	Port 2
PS490105-4-4	2.85" 72.3 mm	2.44" 62.0 mm	1.38" 35.0 mm	1.98" 50.2 mm	1.20" 30.5 mm	.75" 19.0 mm	.56" 14.3 mm	1/4-18 NPTF	7/16-20 UNF-2A
PS690105-6-6	3.05" 77.4 mm	2.54" 64.4 mm	1.55" 39.4 mm	2.20" 55.8 mm	1.29" 32.8 mm	.88" 22.2 mm	.69" 17.5 mm	3/8-18 NPTF	9/16-18 UNF-2A
PS890105-8-8	3.43" 87.0 mm	2.84" 72.0 mm	1.86" 47.2 mm	2.72" 69.2 mm	1.73" 44.0 mm	1.12" 28.6 mm	.88" 22.2 mm	1/2-14 NPTF	3/4-16 UNF-2A
PS1290105-12-12	3.66" 93.0 mm	3.00" 76.1 mm	2.40" 61.0 mm	3.49" 88.5 mm	2.17" 55.2 mm	1.38" 35.0 mm	1.25" 31.8 mm	3/4-14 NPTF	1-1/16-12 UN-2A
PS1690105-16-16	4.41" 112.0 mm	3.54" 90.0 mm	2.50" 63.4 mm	3.74" 94.9 mm	2.48" 63.0 mm	1.62" 41.3 mm	1.50" 38.1 mm	1-11/2 NPTF	1-5/16-12 UN-2A

Male Pipe - Female 37° Flare

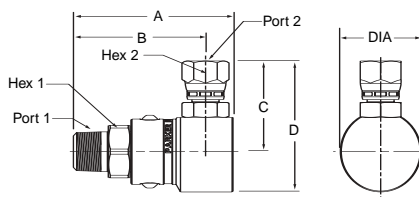

Part Number	A	B	C	D	Dia.	Hex 1	Hex 2	Port 1	Port 2
PS490106-4-4	2.85" 72.3 mm	2.44" 62.0 mm	1.47" 37.3 mm	2.07" 52.5 mm	1.20" 30.5 mm	.75" 19.0 mm	.56" 14.3 mm	1/4-18 NPTF	7/16-20 UNF-2B
PS690106-6-6	3.05" 77.4 mm	2.54" 64.4 mm	1.57" 39.9 mm	2.22" 56.3 mm	1.29" 32.8 mm	.88" 22.2 mm	.69" 17.5 mm	3/8-18 NPTF	9/16-18 UNF-2B
PS890106-8-8	3.43" 87.0 mm	2.84" 72.0 mm	1.91" 48.4 mm	2.77" 70.4 mm	1.73" 44.0 mm	1.12" 28.6 mm	.88" 22.2 mm	1/2-14 NPTF	3/4-16 UNF-2B
PS1290106-12-12	3.66" 93.0 mm	3.00" 76.1 mm	2.34" 59.4 mm	3.43" 87.0 mm	2.17" 55.2 mm	1.38" 35.0 mm	1.25" 31.8 mm	3/4-14 NPTF	1-1/16-12 UN-2B
PS1690106-16-16	4.41" 112.0 mm	3.54" 90.0 mm	2.54" 64.6 mm	3.79" 96.2 mm	2.48" 63.0 mm	1.62" 41.3 mm	1.50" 38.1 mm	1-11/2 NPTF	1-5/16-12 UN-2B

Male Pipe - Female NPSM Pipe Swivel

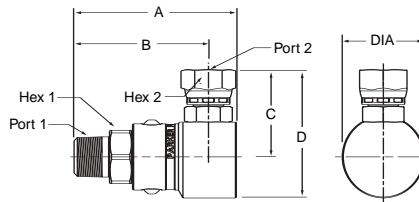

Part Number	A	B	C	D	Dia.	Hex 1	Hex 2	Port 1	Port 2
PS490107-4-4	2.85" 72.3 mm	2.44" 62.0 mm	1.48" 37.5 mm	2.08" 52.8 mm	1.20" 30.5 mm	.75" 19.0 mm	.69" 17.4 mm	1/4-18 NPTF	1/4-18 NPSM
PS690107-6-6	3.05" 77.4 mm	2.54" 64.4 mm	1.51" 38.4 mm	2.16" 54.8 mm	1.29" 32.8 mm	.88" 22.2 mm	.88" 22.2 mm	3/8-18 NPTF	3/8-18 NPSM
PS890107-8-8	3.43" 87.0 mm	2.84" 72.0 mm	1.86" 47.2 mm	2.72" 69.2 mm	1.73" 44.0 mm	1.12" 28.6 mm	1.00" 25.4 mm	1/2-14 NPTF	1/2-14 NPSM
PS1290107-12-12	3.66" 93.0 mm	3.00" 76.1 mm	2.24" 56.9 mm	3.33" 84.5 mm	2.17" 55.2 mm	1.38" 35.0 mm	1.25" 31.8 mm	3/4-14 NPTF	3/4-14 NPSM
PS1690107-16-16	4.41" 112.0 mm	3.54" 90.0 mm	2.48" 63.1 mm	3.73" 94.6 mm	2.48" 63.0 mm	1.62" 41.3 mm	1.50" 38.1 mm	1-11/2 NPTF	1-11/2 NPSM

Male Pipe - Female SAE Straight Thread

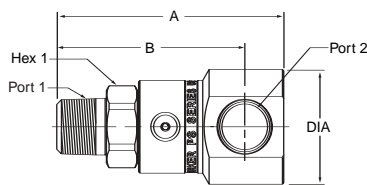

Part Number	A	B	Dia.	Hex 1	Port 1	Port 2
PS490110-4-4	2.85" 72.3 mm	2.44" 62.0 mm	1.20" 30.5 mm	.75" 19.0 mm	1/4-18 NPTF	7/16-20 UNF-2B
PS690110-6-6	3.05" 77.4 mm	2.54" 64.4 mm	1.29" 32.8 mm	.88" 22.2 mm	3/8-18 NPTF	9/16-18 UNF-2B
PS890110-8-8	3.43" 87.0 mm	2.84" 72.0 mm	1.73" 44.0 mm	1.12" 28.6 mm	1/2-14 NPTF	3/4-16 UNF-2B
PS1290110-12-12	3.66" 93.0 mm	3.00" 76.1 mm	2.17" 55.2 mm	1.38" 35.0 mm	3/4-14 NPTF	1-1/16-12 UN-2B
PS1690110-16-16	4.41" 112.0 mm	3.54" 90.0 mm	2.48" 63.0 mm	1.62" 41.3 mm	1-11/2 NPTF	1-5/16-12 UN-2B

Swivels

90° PS Series

Male Pipe - O-Ring Face Seal

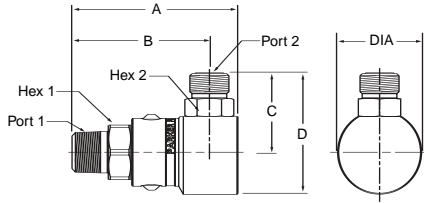

Part Number	A	B	C	D	Dia.	Hex 1	Hex 2	Port 1	Port 2
PS4901JM-4-4	2.85" 72.3 mm	2.44" 62.0 mm	1.29" 32.5 mm	1.89" 47.9 mm	1.20" 30.5 mm	.75" 19.0 mm	.56" 14.3 mm	1/4-18 NPTF	9/16-18 UNF-2A
PS6901JM-6-6	3.05" 77.4 mm	2.54" 64.4 mm	1.40" 35.6 mm	2.05" 52.0 mm	1.29" 32.8 mm	.88" 22.2 mm	.69" 17.5 mm	3/8-18 NPTF	11/16-16 UN-2A
PS8901JM-8-8	3.43" 87.0 mm	2.84" 72.0 mm	1.74" 44.1 mm	2.60" 66.1 mm	1.73" 44.0 mm	1.12" 28.6 mm	.88" 22.2 mm	1/2-14 NPTF	13/16-16 UN-2A
PS12901JM-12-12	3.66" 93.0 mm	3.00" 76.1 mm	2.18" 55.4 mm	3.27" 83.0 mm	2.17" 55.2 mm	1.38" 35.0 mm	1.25" 31.8 mm	3/4-14 NPTF	1-3/16-12 UN-2A
PS16901JM-16-16	4.41" 112.0 mm	3.54" 90.0 mm	2.34" 59.6 mm	3.59" 91.1 mm	2.48" 63.0 mm	1.62" 41.3 mm	1.50" 38.1 mm	1-11/2 NPTF	1-7/16-12 UN-2A

Female Pipe - Female Pipe

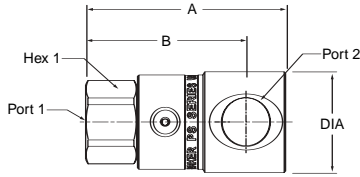

Part Number	A	B	Dia	Hex 1	Port 1	Port 2
PS490202-4-4	2.42" 61.4 mm	2.01" 51.2 mm	1.20" 30.5 mm	.75" 19.0 mm	1/4-18 NPTF	1/4-18 NPTF
PS690202-6-6	2.68" 68.2 mm	2.17" 55.2 mm	1.29" 32.8 mm	.88" 22.2 mm	3/8-18 NPTF	3/8-18 NPTF
PS890202-8-8	2.96" 75.3 mm	2.37" 60.3 mm	1.49" 37.8 mm	1.12" 28.6 mm	1/2-14 NPTF	1/2-14 NPTF
PS1290202-12-12	3.43" 87.2 mm	2.77" 70.4 mm	1.76" 44.6 mm	1.38" 35.0 mm	3/4-14 NPTF	3/4-14 NPTF
PS1690202-16-16	4.03" 102.3 mm	3.16" 80.3 mm	2.16" 54.9 mm	1.62" 41.3 mm	1-11/2 NPTF	1-11/2 NPTF

3 Piece Design

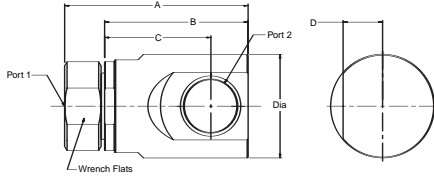

Part Number	A	B	C	D	Wrench Flats	Dia.	Port 1	Port 2
PS2490202-20-20	5.91" 150.2 mm	4.63" 117.5 mm	3.43" 87.0 mm	1.27" 32.3 mm	2.63" 66.7 mm	3.36" 85.2 mm	1 1/4-11 1/2 NPTF	1 1/4-11 1/2 NPTF
PS2490202-24-24	5.91" 150.2 mm	4.63" 117.5 mm	3.43" 87.0 mm	1.27" 32.3 mm	2.63" 66.7 mm	3.36" 85.2 mm	1 1/2-11 1/2 NPTF	1 1/2-11 1/2 NPTF
PS3290202-32-32	6.75" 171.5 mm	5.45" 138.4 mm	3.93" 99.7 mm	1.52" 38.5 mm	3.06" 77.6 mm	4.19" 106.4 mm	2 11-1/2 NPTF	2 11-1/2 NPTF

Female Pipe - Male 37° Flare

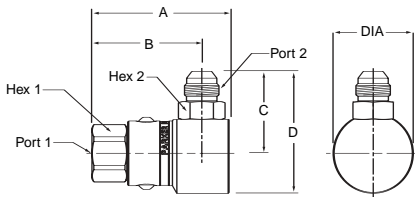

Part Number	A	B	C	D	Dia	Hex 1	Hex 2	Port 1	Port 2
PS490203-4-4	2.42" 61.4 mm	2.01" 51.2 mm	1.39" 35.2 mm	1.99" 50.5 mm	1.20" 30.5 mm	.75" 19.0 mm	.56" 14.3 mm	1/4-18 NPTF	7/16-20 UNF-2A
PS690203-6-6	2.68" 68.2 mm	2.17" 55.2 mm	1.44" 36.6 mm	2.09" 53.0 mm	1.29" 32.8 mm	.88" 22.2 mm	.69" 17.5 mm	3/8-18 NPTF	9/16-18 UNF-2A
PS890203-8-8	2.96" 75.3 mm	2.37" 60.3 mm	1.78" 45.1 mm	2.64" 67.1 mm	1.73" 44.0 mm	1.12" 28.6 mm	.88" 22.2 mm	1/2-14 NPTF	3/4-16 UNF-2A
PS1290203-12-12	3.43" 87.2 mm	2.77" 70.4 mm	2.24" 56.9 mm	3.86" 85.3 mm	2.17" 55.2 mm	1.38" 35.0 mm	1.25" 31.8 mm	3/4-14 NPTF	1-1/16-12 UN-2A
PS1690203-16-16	4.03" 102.3 mm	3.16" 80.3 mm	2.42" 61.3 mm	3.66" 92.9 mm	2.48" 63.0 mm	1.62" 41.3 mm	1.50" 38.1 mm	1-11/2 NPTF	1-5/16-12 UN-2A

3 Piece Design

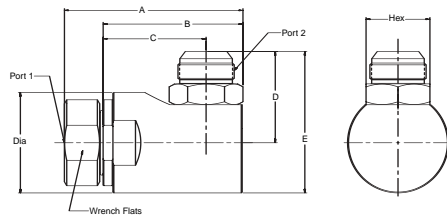

Part Number	A	B	C	D	E	Hex	Wrench Flats	Dia.	Port 1	Port 2
PS2490203-20-20	5.91" 150.2 mm	4.63" 117.5 mm	3.43" 87.0 mm	2.85" 72.4 mm	4.53" 115.0 mm	1.88" 47.6 mm	2.63" 66.7 mm	3.36" 85.2 mm	1 1/4-11 1/2 NPTF	1 5/8-12 UN-2A
PS2490203-24-24	5.94" 150.9 mm	4.65" 118.2 mm	3.43" 87.0 mm	3.05" 77.6 mm	4.73" 120.2 mm	2.13" 54.0 mm	2.63" 66.7 mm	3.36" 85.2 mm	1 1/2-11 1/2 NPTF	1 7/8-12 UN-2A
PS3290203-32-32	6.82" 173.1 mm	5.51" 140.0 mm	3.93" 99.7 mm	3.70" 94.0 mm	5.80" 147.2 mm	2.75" 69.8 mm	3.06" 77.6 mm	4.19" 106.4 mm	2 11-1/2 NPTF	2 1/2-12 UN-2A

Female Pipe - Male SAE O-Ring Straight Thread

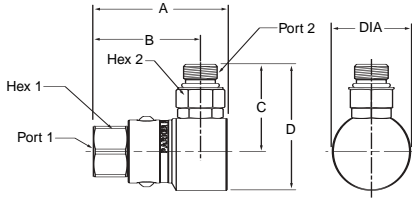

Part Number	A	B	C	D	Dia.	Hex 1	Hex 2	Port 1	Port 2
PS490205-4-4	2.42" 61.4 mm	2.01" 51.2 mm	1.38" 35.0 mm	1.98" 50.2 mm	1.20" 30.5 mm	.75" 19.0 mm	.56" 14.3 mm	1/4-18 NPTF	7/16-20 UNF-2A
PS690205-6-6	2.68" 68.2 mm	2.17" 55.2 mm	1.55" 39.4 mm	2.20" 55.8 mm	1.29" 32.8 mm	.88" 22.2 mm	.69" 17.5 mm	3/8-18 NPTF	9/16-18 UNF-2A
PS890205-8-8	2.96" 75.3 mm	2.37" 60.3 mm	1.86" 47.2 mm	2.72" 69.2 mm	1.73" 44.0 mm	1.12" 28.6 mm	.88" 22.2 mm	1/2-14 NPTF	3/4-16 UNF-2A
PS1290205-12-12	3.43" 87.2 mm	2.77" 70.4 mm	2.40" 61.0 mm	3.49" 88.5 mm	2.17" 55.2 mm	1.38" 35.0 mm	1.25" 31.8 mm	3/4-14 NPTF	1-1/16-12 UN-2A
PS1690205-16-16	4.03" 102.3 mm	3.16" 80.3 mm	2.50" 63.4 mm	3.74" 94.9 mm	2.48" 63.0 mm	1.62" 41.3 mm	1.50" 38.1 mm	1-11/2 NPTF	1-5/16-12 UN-2A

Female Pipe - Female 37° Flare

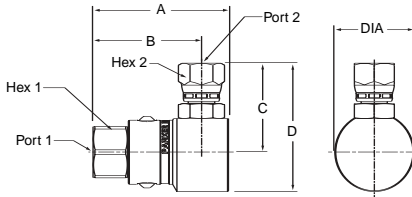

Part Number	A	B	C	D	Dia.	Hex 1	Hex 2	Port 1	Port 2
PS490206-4-4	2.42" 61.4 mm	2.01" 51.2 mm	1.47" 37.3 mm	2.07" 52.5 mm	1.20" 30.5 mm	.75" 19.0 mm	.56" 14.3 mm	1/4-18 NPTF	7/16-20 UNF-2A
PS690206-6-6	2.68" 68.2 mm	2.17" 55.2 mm	1.57" 39.9 mm	2.22" 56.3 mm	1.29" 32.8 mm	.88" 22.2 mm	.69" 17.5 mm	3/8-18 NPTF	9/16-18 UNF-2A
PS890206-8-8	2.96" 75.3 mm	2.37" 60.3 mm	1.91" 48.4 mm	2.77" 70.4 mm	1.73" 44.0 mm	1.12" 28.6 mm	.88" 22.2 mm	1/2-14 NPTF	3/4-16 UNF-2A
PS1290206-12-12	3.43" 87.2 mm	2.77" 70.4 mm	2.34" 59.4 mm	3.43" 87.0 mm	2.17" 55.2 mm	1.38" 35.0 mm	1.25" 31.8 mm	3/4-14 NPTF	1-1/16-12 UN-2A
PS1690206-16-16	4.03" 102.3 mm	3.16" 80.3 mm	2.54" 64.6 mm	3.79" 96.2 mm	2.48" 63.0 mm	1.62" 41.3 mm	1.50" 38.1 mm	1-11/2 NPTF	1-5/16-12 UN-2A

Female Pipe - Female NPSM Pipe Swivel

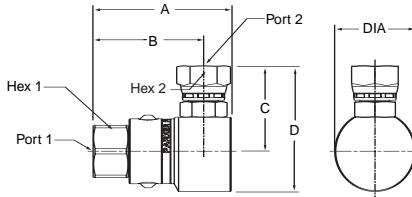

Part Number	A	B	C	D	Dia.	Hex 1	Hex 2	Port 1	Port 2
PS490207-4-4	2.42" 61.4 mm	2.01" 51.2 mm	1.48" 37.5 mm	2.08" 52.8 mm	1.20" 30.5 mm	.75" 19.0 mm	.69" 17.4 mm	1/4-18 NPTF	1/4-18 NPSM
PS690207-6-6	2.68" 68.2 mm	2.17" 55.2 mm	1.51" 38.4 mm	2.16" 54.8 mm	1.29" 32.8 mm	.88" 22.2 mm	.69" 17.5 mm	3/8-18 NPTF	3/8-18 NPSM
PS890207-8-8	2.96" 75.3 mm	2.37" 60.3 mm	1.86" 47.2 mm	2.72" 69.2 mm	1.73" 44.0 mm	1.12" 28.6 mm	1.00" 25.4 mm	1/2-14 NPTF	1/2-14 NPSM
PS1290207-12-12	3.43" 87.2 mm	2.77" 70.4 mm	2.24" 56.9 mm	3.33" 84.5 mm	2.17" 55.2 mm	1.38" 35.0 mm	1.25" 31.8 mm	3/4-14 NPTF	3/4-14 NPSM
PS1690207-16-16	4.03" 102.3 mm	3.16" 80.3 mm	2.48" 63.1 mm	3.73" 94.6 mm	2.48" 63.0 mm	1.62" 41.3 mm	1.50" 38.1 mm	1-11/2 NPTF	1-11/2 NPSM

Female Pipe - Female SAE Straight Thread

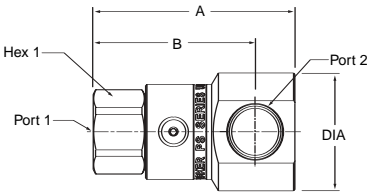

Part Number	A	B	Dia.	Hex 1	Port 1	Port 2
PS490210-4-4	2.42" 61.4 mm	2.01" 51.2 mm	1.20" 30.5 mm	.75" 19.0 mm	1/4-18 NPTF	7/16-20 UNF-2B
PS690210-6-6	2.68" 68.2 mm	2.17" 55.2 mm	1.29" 32.8 mm	.88" 22.2 mm	3/8-18 NPTF	9/16-18 UNF-2B
PS890210-8-8	2.96" 75.3 mm	2.37" 60.3 mm	1.73" 44.0 mm	1.12" 28.6 mm	1/2-14 NPTF	3/4-16 UNF-2B
PS1290210-12-12	3.43" 87.2 mm	2.77" 70.4 mm	2.17" 55.2 mm	1.38" 35.0 mm	3/4-14 NPTF	1-1/16-12 UN-2B
PS1690210-16-16	4.03" 102.3 mm	3.16" 80.3 mm	2.48" 63.0 mm	1.62" 41.3 mm	1-11/2 NPTF	1-5/16-12 UN-2B

3 Piece Design

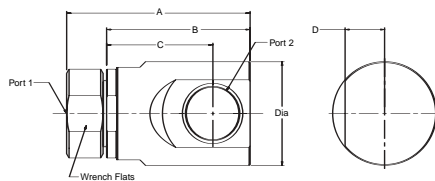

Part Number	A	B	C	D	Wrench Flats	Dia.	Port 1	Port 2
PS2490210-20-20	5.91" 150.2 mm	4.63" 117.5 mm	3.43" 87.0 mm	1.27" 32.3 mm	2.63" 66.7 mm	3.36" 85.2 mm	1 1/4-11 1/2 NPTF	1 5/8-12 UN-2B
PS2490210-24-24	5.91" 150.2 mm	4.63" 117.5 mm	3.43" 87.0 mm	1.27" 32.3 mm	2.63" 66.7 mm	3.36" 85.2 mm	1 1/4-11 1/2 NPTF	1 5/8-12 UN-2B
PS3290210-32-32	6.75" 171.5 mm	5.45" 138.4 mm	3.93" 99.7 mm	1.52" 38.5 mm	3.06" 77.6 mm	4.19" 106.4 mm	2 11/2 NPTF	2-1/2-12 UN-2B

D Swivels

Female Pipe - O-Ring Face Seal

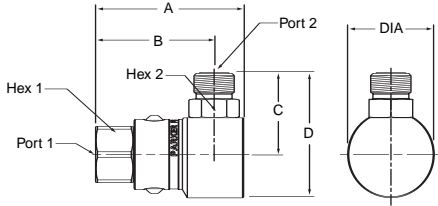

Part Number	A	B	C	D	Dia.	Hex 1	Hex 2	Port 1	Port 2
PS4902JM-4-4	2.42" 61.4 mm	2.01" 51.2 mm	1.29" 32.5 mm	1.89" 47.9 mm	1.20" 30.5 mm	.75" 19.0 mm	.56" 14.3 mm	1/4-18 NPTF	9/16-18 UNF-2A
PS6902JM-6-6	2.68" 68.2 mm	2.17" 55.2 mm	1.40" 35.6 mm	2.05" 52.0 mm	1.29" 32.8 mm	.88" 22.2 mm	.69" 17.5 mm	3/8-18 NPTF	11/16-16 UN-2A
PS8902JM-8-8	2.96" 75.3 mm	2.37" 60.3 mm	1.74" 44.1 mm	2.60" 66.1 mm	1.73" 44.0 mm	1.12" 28.6 mm	.88" 22.2 mm	1/2-14 NPTF	13/16-16 UN-2A
PS12902JM-12-12	3.43" 87.2 mm	2.77" 70.4 mm	2.18" 55.4 mm	3.27" 83.0 mm	2.17" 55.2 mm	1.38" 35.0 mm	1.25" 31.8 mm	3/4-14 NPTF	1-3/16-12 UN-2A
PS16902JM-16-16	4.03" 102.3 mm	3.16" 80.3 mm	2.34" 59.6 mm	3.59" 91.1 mm	2.48" 63.0 mm	1.62" 41.3 mm	1.50" 38.1 mm	1-11 1/2 NPTF	1-7/16-12 UN-2A

Male 37° Flare - Female Pipe

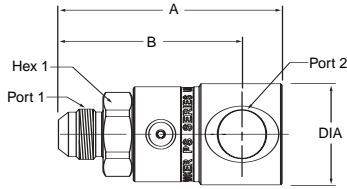

Part Number	A	B	Dia.	Hex 1	Port 1	Port 2
PS490302-4-4	2.85" 72.3 mm	2.44" 62.0 mm	1.20" 30.5 mm	.75" 19.0 mm	7/16-20 UNF-2A	1/4-18 NPTF
PS690302-6-6	3.05" 77.4 mm	2.54" 64.4 mm	1.29" 32.8 mm	.88" 22.2 mm	9/16-18 UNF-2A	3/8-18 NPTF
PS890302-8-8	3.29" 83.7 mm	2.70" 68.7 mm	1.49" 37.8 mm	1.12" 28.6 mm	3/4-16 UNF-2A	1/2-14 NPTF
PS1290302-12-12	3.76" 95.6 mm	3.10" 78.8 mm	1.76" 44.6 mm	1.38" 35.0 mm	1-1/16-12 UN-2A	3/4-14 NPTF
PS1690302-16-16	4.41" 112.0 mm	3.54" 90.0 mm	2.16" 54.9 mm	1.62" 41.3 mm	1-5/16-12 UN-2A	1-11 1/2 NPTF

3 Piece Design

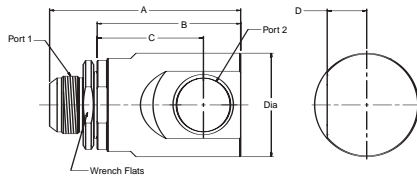

Part Number	A	B	C	D	Wrench Flats	Dia.	Port 1	Port 2
PS2490302-20-20	6.16" 150.2 mm	4.63" 117.5 mm	3.43" 87.0 mm	1.27" 32.3 mm	2.63" 66.7 mm	3.36" 85.2 mm	1 5/8-12 UN-2A	1 1/4-11 1/2 NPTF
PS2490302-24-24	6.16" 150.2 mm	4.63" 117.5 mm	3.43" 87.0 mm	1.27" 32.3 mm	2.63" 66.7 mm	3.36" 85.2 mm	1 7/8-12 UN-2A	1 1/2-11 1/2 NPTF
PS3290302-32-32	7.38" 187.4 mm	5.45" 138.4 mm	3.93" 99.7 mm	1.52" 38.5 mm	3.06" 77.6 mm	4.19" 106.4 mm	2 1/2-12 UN-2A	2-11-1/2 NPTF

Male 37° Flare - Male 37° Flare

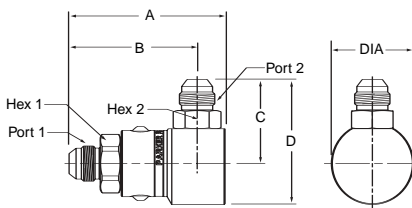

Part Number	A	B	C	D	Dia.	Hex 1	Hex 2	Port 1	Port 2
PS490303-4-4	2.85" 72.3 mm	2.44" 62.0 mm	1.39" 35.2 mm	1.99" 50.5 mm	1.20" 30.5 mm	.75" 19.0 mm	.56" 14.3 mm	7/16-20 UNF-2A	7/16-20 UNF-2A
PS690303-6-6	3.05" 77.4 mm	2.54" 64.4 mm	1.44" 36.6 mm	2.09" 53.0 mm	1.29" 32.8 mm	.88" 22.2 mm	.69" 17.5 mm	9/16-18 UNF-2A	9/16-18 UNF-2A
PS890303-8-8	3.29" 83.7 mm	2.70" 68.7 mm	1.78" 45.1 mm	2.64" 67.1 mm	1.73" 44.0 mm	1.12" 28.6 mm	.88" 22.2 mm	3/4-16 UNF-2A	3/4-16 UNF-2A
PS890303-10-10	3.39" 86.2 mm	2.80" 71.2 mm	1.90" 48.4 mm	2.77" 70.4 mm	1.73" 44.0 mm	1.12" 28.6 mm	.88" 22.2 mm	7/8-14 UNF-2A	7/8-14 UNF-2A
PS1290303-12-12	3.76" 95.6 mm	3.10" 78.8 mm	2.24" 56.9 mm	3.86" 98.3 mm	2.17" 55.2 mm	1.38" 35.0 mm	1.25" 31.8 mm	1-1/16-12 UN-2A	1-1/16-12 UN-2A
PS1690303-16-16	4.41" 112.0 mm	3.54" 90.0 mm	2.42" 61.3 mm	3.66" 92.9 mm	2.48" 63.0 mm	1.62" 41.3 mm	1.50" 38.1 mm	1-5/16-12 UN-2A	1-5/16-12 UN-2A

3 Piece Design

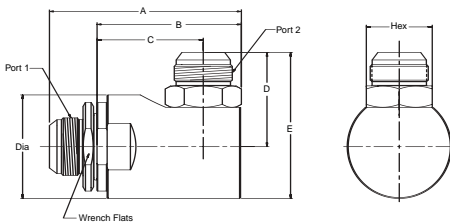

Part Number	A	B	C	D	E	Hex	Wrench Flats	Dia.	Port 1	Port 2
PS2490303-20-20	6.16" 156.4 mm	4.63" 117.5 mm	3.43" 87.0 mm	2.85" 72.4 mm	4.53" 115.0 mm	1.88" 47.6 mm	2.63" 66.7 mm	3.36" 85.2 mm	1 5/8-12 UN-2A	1 5/8-12 UN-2A
PS2490303-24-24	5.81" 157.1 mm	4.65" 118.2 mm	3.43" 87.0 mm	3.05" 77.6 mm	4.73" 120.2 mm	2.13" 54.0 mm	2.63" 66.7 mm	3.36" 85.2 mm	1 7/8-12 UN-2A	1 7/8-12 UN-2A
PS3290303-32-32	7.44" 189.0 mm	5.51" 140.0 mm	3.93" 99.7 mm	3.70" 94.0 mm	5.80" 147.2 mm	2.75" 69.8 mm	3.06" 77.6 mm	4.19" 106.4 mm	2 1/2-12 UN-2A	2 1/2-12 UN-2A

D Swivels

Male 37° Flare - Male SAE O-Ring Straight Thread

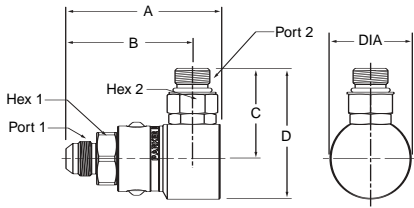

Part Number	A	B	C	D	Dia.	Hex 1	Hex 2	Port 1	Port 2
PS490305-4-4	2.85" 72.3 mm	2.44" 62.0 mm	1.38" 35.0 mm	1.98" 50.2 mm	1.20" 30.5 mm	.75" 19.0 mm	.56" 14.3 mm	7/16-20 UNF-2A	7/16-20 UNF-2A
PS690305-6-6	3.05" 77.4 mm	2.54" 64.4 mm	1.55" 39.4 mm	2.20" 55.8 mm	1.29" 32.8 mm	.88" 22.2 mm	.69" 17.5 mm	9/16-18 UNF-2A	9/16-18 UNF-2A
PS890305-8-8	3.29" 83.7 mm	2.70" 68.7 mm	1.86" 47.2 mm	2.72" 69.2 mm	1.73" 44.0 mm	1.12" 28.6 mm	.88" 22.2 mm	3/4-16 UNF-2A	3/4-16 UNF-2A
PS1290305-12-12	3.76" 95.6 mm	3.10" 78.8 mm	2.40" 61.0 mm	3.49" 88.5 mm	2.17" 55.2 mm	1.38" 35.0 mm	1.25" 31.8 mm	1-1/16-12 UN-2A	1-1/16-12 UN-2A
PS1690305-16-16	4.41" 112.0 mm	3.54" 90.0 mm	2.50" 63.4 mm	3.74" 94.9 mm	2.48" 63.0 mm	1.62" 41.3 mm	1.50" 38.1 mm	1-5/16-12 UN-2A	1-5/16-12 UN-2A

Male 37° Flare - Female 37° Flare

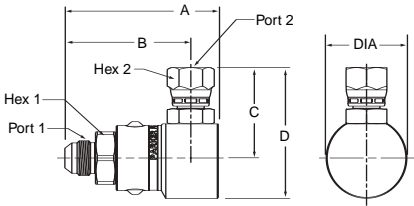

Part Number	A	B	C	D	Dia.	Hex 1	Hex 2	Port 1	Port 2
PS490306-4-4	2.85" 72.3 mm	2.44" 62.0 mm	1.47" 37.3 mm	2.07" 52.5 mm	1.20" 30.5 mm	.75" 19.0 mm	.56" 14.3 mm	7/16-20 UNF-2A	7/16-20 UNF-2B
PS690306-6-6	3.05" 77.4 mm	2.54" 64.4 mm	1.57" 39.9 mm	2.22" 56.3 mm	1.29" 32.8 mm	.88" 22.2 mm	.69" 17.5 mm	9/16-18 UNF-2A	9/16-18 UNF-2B
PS890306-8-8	3.29" 83.7 mm	2.70" 68.7 mm	1.91" 48.4 mm	2.77" 70.4 mm	1.73" 44.0 mm	1.12" 28.6 mm	.88" 22.2 mm	3/4-16 UNF-2A	3/4-16 UNF-2B
PS1290306-12-12	3.76" 95.6 mm	3.10" 78.8 mm	2.34" 59.4 mm	3.43" 87.0 mm	2.17" 55.2 mm	1.38" 35.0 mm	1.25" 31.8 mm	1-1/16-12 UN-2A	1-1/16-12 UN-2B
PS1690306-16-16	4.41" 112.0 mm	3.54" 90.0 mm	2.54" 64.6 mm	3.79" 96.2 mm	2.48" 63.0 mm	1.62" 41.3 mm	1.50" 38.1 mm	1-5/16-12 UN-2A	1-5/16-12 UN-2B

Male 37° Flare - Female NPSM Pipe Swivel

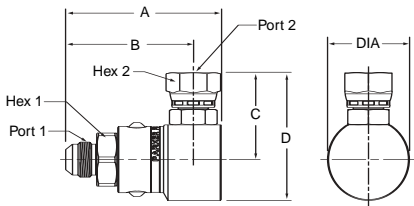

Part Number	A	B	C	D	Dia.	Hex 1	Hex 2	Port 1	Port 2
PS490307-4-4	2.85" 72.3 mm	2.44" 62.0 mm	1.48" 37.5 mm	2.08" 52.8 mm	1.20" 30.5 mm	.75" 19.0 mm	.69" 17.4 mm	7/16-20 UNF-2A	1/4-18 NPSM
PS690307-6-6	3.05" 77.4 mm	2.54" 64.4 mm	1.51" 38.4 mm	2.16" 54.8 mm	1.29" 32.8 mm	.88" 22.2 mm	.88" 22.2 mm	9/16-18 UNF-2A	3/8-18 NPSM
PS890307-8-8	3.29" 83.7 mm	2.70" 68.7 mm	1.86" 47.2 mm	2.72" 69.2 mm	1.73" 44.0 mm	1.12" 28.6 mm	1.00" 25.4 mm	3/4-16 UNF-2A	1/2-14 NPSM
PS1290307-12-12	3.76" 95.6 mm	3.10" 78.8 mm	2.24" 56.9 mm	3.33" 84.5 mm	2.17" 55.2 mm	1.38" 35.0 mm	1.25" 31.8 mm	1-1/16-12 UN-2A	3/4-14 NPSM
PS1690307-16-16	4.41" 112.0 mm	3.54" 90.0 mm	2.48" 63.1 mm	3.73" 94.6 mm	2.48" 63.0 mm	1.62" 41.3 mm	1.50" 38.1 mm	1-5/16-12 UN-2A	1-11/2 NPSM

Male 37° Flare - Female SAE Straight Thread

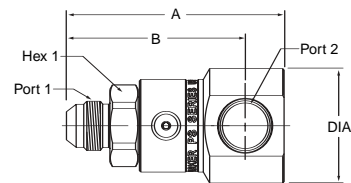

Part Number	A	B	Dia.	Hex 1	Port 1	Port 2
PS490310-4-4	2.85" 72.3 mm	2.44" 62.0 mm	1.20" 30.5 mm	.75" 19.0 mm	7/16-20 UNF-2A	7/16-20 UNF-2B
PS690310-6-6	3.05" 77.4 mm	2.54" 64.4 mm	1.29" 32.8 mm	.88" 22.2 mm	9/16-18 UNF-2A	9/16-18 UNF-2B
PS890310-8-8	3.29" 83.7 mm	2.70" 68.7 mm	1.73" 44.0 mm	1.12" 28.6 mm	3/4-16 UNF-2A	3/4-16 UNF-2B
PS1290310-12-12	3.76" 95.6 mm	3.10" 78.8 mm	2.17" 55.2 mm	1.38" 35.0 mm	1-1/16-12 UN-2A	1-1/16-12 UN-2B
PS1690310-16-16	4.41" 112.0 mm	3.54" 90.0 mm	2.48" 63.0 mm	1.62" 41.3 mm	1-1/16-12 UN-2A	1-1/16-12 UN-2B

Male 37° Flare - O-Ring Face Seal

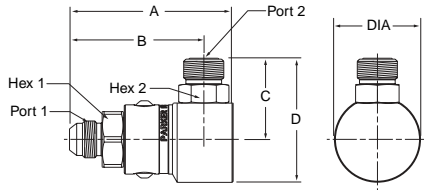

Part Number	A	B	C	D	Dia.	Hex 1	Hex 2	Port 1	Port 2
PS4903JM-4-4	2.85" 72.3 mm	2.44" 62.0 mm	1.29" 32.5 mm	1.89" 47.9 mm	1.20" 30.5 mm	.75" 19.0 mm	.56" 14.3 mm	7/16-20 UNF-2A	9/16-18 UNF-2A
PS6903JM-6-6	3.05" 77.4 mm	2.54" 64.4 mm	1.40" 35.6 mm	2.05" 52.0 mm	1.29" 32.8 mm	.88" 22.2 mm	.69" 17.5 mm	9/16-18 UNF-2A	11/16-16 UN-2A
PS8903JM-8-8	3.29" 83.7 mm	2.70" 68.7 mm	1.74" 44.1 mm	2.60" 66.1 mm	1.73" 44.0 mm	1.12" 28.6 mm	.88" 22.2 mm	3/4-16 UNF-2A	13/16-16 UN-2A
PS8903JM-10-10	3.39" 86.2 mm	2.80" 71.2 mm	1.96" 49.9 mm	2.83" 71.9 mm	1.73" 44.0 mm	1.12" 28.6 mm	.88" 22.2 mm	7/8-14 UNF-2A	1-14 UN-2A
PS12903JM-12-12	3.76" 95.6 mm	3.10" 78.8 mm	2.18" 55.4 mm	3.27" 83.0 mm	2.17" 55.2 mm	1.38" 35.0 mm	1.25" 31.8 mm	1-1/16-12 UN-2A	1-3/16-12 UN-2A
PS16903JM-16-16	4.41" 112.0 mm	3.54" 90.0 mm	2.34" 59.6 mm	3.59" 91.1 mm	2.48" 63.0 mm	1.62" 41.3 mm	1.50" 38.1 mm	1-5/16-12 UN-2A	1-7/16-12 UN-2A

Male SAE O-Ring Straight Thread - Female Pipe

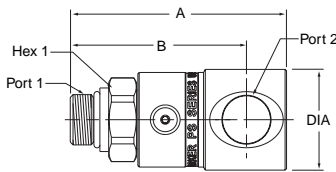

Part Number	A	B	Dia.	Hex 1	Port 1	Port 2
PS490502-4-4	2.70" 68.6 mm	2.29" 58.3 mm	1.20" 30.5 mm	.75" 19.0 mm	7/16-20 UNF-2A	1/4-18 NPTF
PS690502-6-6	2.87" 72.8 mm	2.36" 59.8 mm	1.29" 32.8 mm	.88" 22.2 mm	9/16-18 UNF-2A	3/8-18 NPTF
PS890502-8-8	3.19" 80.9 mm	2.60" 65.9 mm	1.49" 37.8 mm	1.12" 28.6 mm	3/4-16 UNF-2A	1/2-14 NPTF
PS1290502-12-12	3.58" 90.9 mm	2.92" 74.0 mm	1.76" 44.6 mm	1.38" 35.0 mm	1-1/16-12 UN-2A	3/4-14 NPTF
PS1690502-16-16	4.18" 106.3 mm	3.32" 84.3 mm	2.16" 54.9 mm	1.62" 41.3 mm	1-5/16-12 UN-2A	1-11/2 NPTF

Male SAE O-Ring Straight Thread - Male 37° Flare

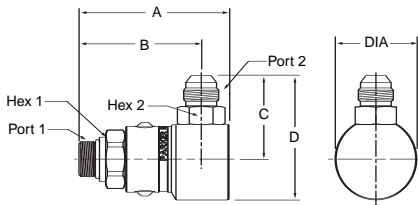

Part Number	A	B	C	D	Dia.	Hex 1	Hex 2	Port 1	Port 2
PS490503-4-4	2.70" 68.6 mm	2.29" 58.3 mm	1.39" 35.2 mm	1.99" 50.5 mm	1.20" 30.5 mm	.75" 19.0 mm	.56" 14.3 mm	7/16-20 UNF-2A	7/16-20 UNF-2A
PS690503-6-6	2.87" 72.8 mm	2.36" 59.8 mm	1.44" 36.6 mm	2.09" 53.0 mm	1.29" 32.8 mm	.88" 22.2 mm	.69" 17.5 mm	9/16-18 UNF-2A	9/16-18 UNF-2A
PS890503-8-8	3.19" 80.9 mm	2.60" 65.9 mm	1.78" 45.1 mm	2.64" 67.1 mm	1.73" 44.0 mm	1.12" 28.6 mm	.88" 22.2 mm	3/4-16 UNF-2A	3/4-16 UNF-2A
PS890503-10-10	3.25" 82.5 mm	2.66" 67.5 mm	1.90" 48.4 mm	2.77" 70.4 mm	1.73" 44.0 mm	1.12" 28.6 mm	.88" 22.2 mm	7/8-14 UNF-2A	7/8-14 UNF-2A
PS1290503-12-12	3.58" 90.9 mm	2.92" 74.0 mm	2.24" 56.9 mm	3.86" 98.3 mm	2.17" 55.2 mm	1.38" 35.0 mm	1.25" 31.8 mm	1-1/16-12 UN-2A	1-1/16-12 UN-2A
PS1690503-16-16	4.18" 106.3 mm	3.32" 84.3 mm	2.42" 61.3 mm	3.66" 92.9 mm	2.48" 63.0 mm	1.62" 41.3 mm	1.50" 38.1 mm	1-5/16-12 UN-2A	1-5/16-12 UN-2A

Male SAE O-Ring Straight Thread - Male SAE O-Ring Straight Thread

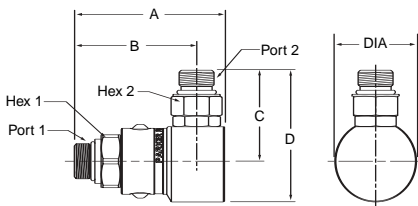

Part Number	A	B	C	D	Dia.	Hex 1	Hex 2	Port 1	Port 2
PS490505-4-4	2.70" 68.6 mm	2.29" 58.3 mm	1.38" 35.0 mm	1.98" 50.2 mm	1.20" 30.5 mm	.75" 19.0 mm	.56" 14.3 mm	7/16-20 UNF-2A	7/16-20 UNF-2A
PS690505-6-6	2.87" 72.8 mm	2.36" 59.8 mm	1.55" 39.4 mm	2.20" 55.8 mm	1.29" 32.8 mm	.88" 22.2 mm	.69" 17.5 mm	9/16-18 UNF-2A	9/16-18 UNF-2A
PS890505-8-8	3.19" 80.9 mm	2.60" 65.9 mm	1.86" 47.2 mm	2.72" 69.2 mm	1.73" 44.0 mm	1.12" 28.6 mm	.88" 22.2 mm	3/4-16 UNF-2A	3/4-16 UNF-2A
PS1290505-12-12	3.58" 90.9 mm	2.92" 74.0 mm	2.40" 61.0 mm	3.49" 88.5 mm	2.17" 55.2 mm	1.38" 35.0 mm	1.25" 31.8 mm	1-1/16-12 UN-2A	1-1/16-12 UN-2A
PS1690505-16-16	4.18" 106.3 mm	3.32" 84.3 mm	2.50" 63.4 mm	3.74" 94.9 mm	2.48" 63.0 mm	1.62" 41.3 mm	1.50" 38.1 mm	1-5/16-12 UN-2A	1-5/16-12 UN-2A

D Swivels

Male SAE O-Ring Straight Thread - Female 37° Flare

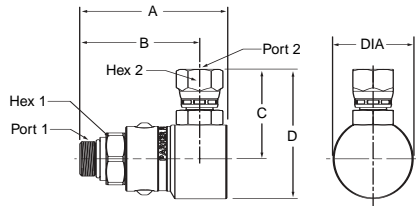

Part Number	A	B	C	D	Dia.	Hex 1	Hex 2	Port 1	Port 2
PS490506-4-4	2.70" 68.6 mm	2.29" 58.3 mm	1.47" 37.3 mm	2.07" 52.5 mm	1.20" 30.5 mm	.75" 19.0 mm	.56" 14.3 mm	7/16-20 UNF-2A	7/16-20 UNF-2B
PS690506-6-6	2.87" 72.8 mm	2.36" 59.8 mm	1.57" 39.9 mm	2.22" 56.3 mm	1.29" 32.8 mm	.88" 22.2 mm	.69" 17.5 mm	9/16-18 UNF-2A	9/16-18 UNF-2B
PS890506-8-8	3.19" 80.9 mm	2.60" 65.9 mm	1.91" 48.4 mm	2.77" 70.4 mm	1.73" 44.0 mm	1.12" 28.6 mm	.88" 22.2 mm	3/4-16 UNF-2A	3/4-16 UNF-2B
PS1290506-12-12	3.58" 90.9 mm	2.92" 74.0 mm	2.34" 59.4 mm	3.43" 87.0 mm	2.17" 55.2 mm	1.38" 35.0 mm	1.25" 31.8 mm	1-1/16-12 UN-2A	1-1/16-12 UN-2B
PS1690506-16-16	4.18" 106.3 mm	3.32" 84.3 mm	2.54" 64.6 mm	3.79" 96.2 mm	2.48" 63.0 mm	1.62" 41.3 mm	1.50" 38.1 mm	1-5/16-12 UN-2A	1-5/16-12 UN-2B

Male SAE O-Ring Straight Thread - Female NPSM Pipe Swivel

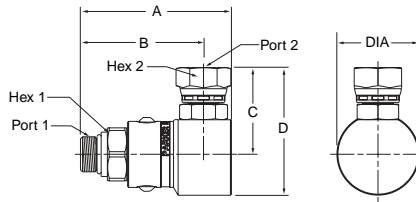

Part Number	A	B	C	D	Dia.	Hex 1	Hex 2	Port 1	Port 2
PS490507-4-4	2.70" 68.6 mm	2.29" 58.3 mm	1.48" 37.5 mm	2.08" 52.8 mm	1.20" 30.5 mm	.75" 19.0 mm	.69" 17.4 mm	7/16-20 UNF-2A	1/4-18 NPSM
PS690507-6-6	2.87" 72.8 mm	2.36" 59.8 mm	1.51" 38.4 mm	2.16" 54.8 mm	1.29" 32.8 mm	.88" 22.2 mm	.88" 22.2 mm	9/16-18 UNF-2A	3/8-18 NPSM
PS890507-8-8	3.19" 80.9 mm	2.60" 65.9 mm	1.86" 47.2 mm	2.72" 69.2 mm	1.73" 44.0 mm	1.12" 28.6 mm	1.00" 25.4 mm	3/4-16 UNF-2A	1/2-14 NPSM
PS1290507-12-12	3.58" 90.9 mm	2.92" 74.0 mm	2.24" 56.9 mm	3.33" 84.5 mm	2.17" 55.2 mm	1.38" 35.0 mm	1.25" 31.8 mm	1-1/16-12 UN-2A	3/4-14 NPSM
PS1690507-16-16	4.18" 106.3 mm	3.32" 84.3 mm	2.48" 63.1 mm	3.73" 94.6 mm	2.48" 63.0 mm	1.62" 41.3 mm	1.50" 38.1 mm	1-5/16-12 UN-2A	1-11/2 NPSM

Male SAE O-Ring Straight Thread - Female SAE Straight Thread

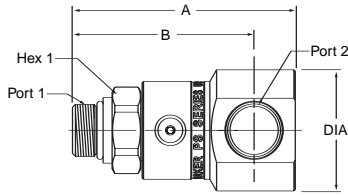

Part Number	A	B	Dia.	Hex 1	Port 1	Port 2
PS490510-4-4	2.70" 68.6 mm	2.29" 58.3 mm	1.20" 30.5 mm	.75" 19.0 mm	7/16-20 UNF-2A	7/16-20 UNF-2B
PS690510-6-6	2.87" 72.8 mm	2.36" 59.8 mm	1.29" 32.8 mm	.88" 22.2 mm	9/16-18 UNF-2A	9/16-18 UNF-2B
PS890510-8-8	3.19" 80.9 mm	2.60" 65.9 mm	1.73" 44.0 mm	1.12" 28.6 mm	3/4-16 UNF-2A	3/4-16 UNF-2B
PS1290510-12-12	3.58" 90.9 mm	2.92" 74.0 mm	2.17" 55.2 mm	1.38" 35.0 mm	1-1/16-12 UN-2A	1-1/16-12 UN-2B
PS1690510-16-16	4.18" 106.3 mm	3.32" 84.3 mm	2.48" 63.0 mm	1.62" 41.3 mm	1-5/16-12 UN-2A	1-5/16-12 UN-2B

Male SAE O-Ring Straight Thread - O-Ring Face Seal

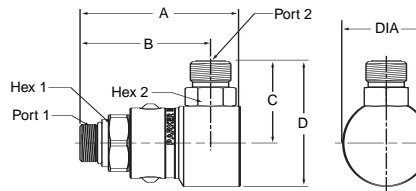

Part Number	A	B	C	D	Dia.	Hex 1	Hex 2	Port 1	Port 2
PS4905JM-4-4	2.70" 68.6 mm	2.29" 58.3 mm	1.29" 32.5 mm	1.89" 47.9 mm	1.20" 30.5 mm	.75" 19.0 mm	.56" 14.3 mm	7/16-20 UNF-2A	9/16-18 UNF-2A
PS6905JM-6-6	2.87" 72.8 mm	2.36" 59.8 mm	1.40" 35.6 mm	2.05" 52.0 mm	1.29" 32.8 mm	.88" 22.2 mm	.69" 17.5 mm	9/16-18 UNF-2A	11/16-16 UN-2A
PS8905JM-8-8	3.19" 80.9 mm	2.60" 65.9 mm	1.74" 44.1 mm	2.60" 66.1 mm	1.73" 44.0 mm	1.12" 28.6 mm	.88" 22.2 mm	3/4-16 UNF-2A	13/16-16 UN-2A
PS8905JM-10-10	3.25" 82.5 mm	2.66" 67.5 mm	1.96" 49.9 mm	2.83" 71.9 mm	1.73" 44.0 mm	1.12" 28.6 mm	.88" 22.2 mm	7/8-14 UNF-2A	1-14 UN-2A
PS12905JM-12-12	3.58" 90.9 mm	2.92" 74.0 mm	2.18" 55.4 mm	3.27" 83.0 mm	2.17" 55.2 mm	1.38" 35.0 mm	1.25" 31.8 mm	1-1/16-12 UN-2A	1-3/16-12 UN-2A
PS16905JM-16-16	4.18" 106.3 mm	3.32" 84.3 mm	2.34" 59.6 mm	3.59" 91.1 mm	2.48" 63.0 mm	1.62" 41.3 mm	1.50" 38.1 mm	1-5/16-12 UN-2A	1-7/16-12 UN-2A

Female SAE Straight Thread - Female Pipe

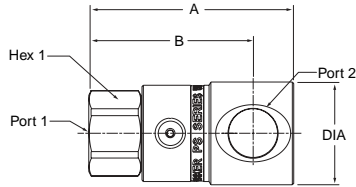

Part Number	A	B	Dia.	Hex 1	Port 1	Port 2
PS491002-4-4	2.42" 61.4 mm	2.01" 51.2 mm	1.20" 30.5 mm	.75" 19.0 mm	7/16-20 UNF-2B	1/4-18 NPTF
PS691002-6-6	2.68" 68.2 mm	2.17" 55.2 mm	1.29" 32.8 mm	.88" 22.2 mm	9/16-18 UNF-2B	3/8-18 NPTF
PS891002-8-8	2.96" 75.3 mm	2.37" 60.3 mm	1.49" 37.8 mm	1.12" 28.6 mm	3/4-16 UNF-2B	1/2-14 NPTF
PS1291002-12-12	3.43" 87.2 mm	2.77" 70.4 mm	1.76" 44.6 mm	1.38" 35.0 mm	1-1/16-12 UN-2B	3/4-14 NPTF
PS1691002-16-16	4.03" 102.3 mm	3.16" 80.3 mm	2.16" 54.9 mm	1.62" 41.3 mm	1-5/16-12 UN-2B	1-11/2 NPTF

Female SAE Straight Thread - Male 37° Flare

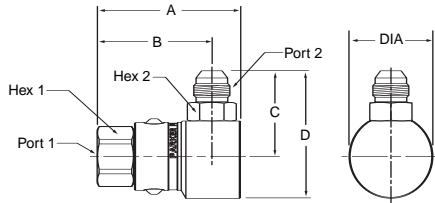

Part Number	A	B	C	D	Dia.	Hex 1	Hex 2	Port 1	Port 2
PS491003-4-4	2.42" 61.4 mm	2.01" 51.2 mm	1.39" 35.2 mm	1.99" 50.5 mm	1.20" 30.5 mm	.75" 19.0 mm	.56" 14.3 mm	7/16-20 UNF-2B	7/16-20 UNF-2A
PS691003-6-6	2.68" 68.2 mm	2.17" 55.2 mm	1.44" 36.6 mm	2.09" 53.0 mm	1.29" 32.8 mm	.88" 22.2 mm	.69" 17.5 mm	9/16-18 UNF-2B	9/16-18 UNF-2A
PS891003-8-8	2.96" 75.3 mm	2.37" 60.3 mm	1.78" 45.1 mm	2.64" 67.1 mm	1.73" 44.0 mm	1.12" 28.6 mm	.88" 22.2 mm	3/4-16 UNF-2B	3/4-16 UNF-2A
PS1291003-12-12	3.43" 87.2 mm	2.77" 70.4 mm	2.24" 56.9 mm	3.86" 98.5 mm	2.17" 55.2 mm	1.38" 35.0 mm	1.25" 31.8 mm	1-1/16-12 UN-2B	1-1/16-12 UN-2A
PS1691003-16-16	4.03" 102.3 mm	3.16" 80.3 mm	2.42" 61.3 mm	3.66" 92.9 mm	2.48" 63.0 mm	1.62" 41.3 mm	1.50" 38.1 mm	1-5/16-12 UN-2B	1-5/16-12 UN-2A

Female SAE Straight Thread - Male SAE O-Ring Straight Thread

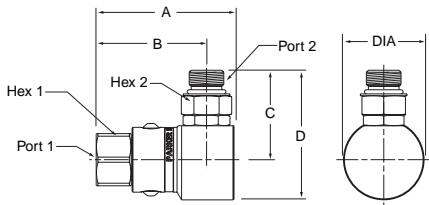

Part Number	A	B	C	D	Dia.	Hex 1	Hex 2	Port 1	Port 2
PS491005-4-4	2.42" 61.4 mm	2.01" 51.2 mm	1.38" 35.0 mm	1.98" 50.2 mm	1.20" 30.5 mm	.75" 19.0 mm	.56" 14.3 mm	7/16-20 UNF-2B	7/16-20 UNF-2A
PS691005-6-6	2.68" 68.2 mm	2.17" 55.2 mm	1.55" 39.4 mm	2.20" 55.8 mm	1.29" 32.8 mm	.88" 22.2 mm	.69" 17.5 mm	9/16-18 UNF-2B	9/16-18 UNF-2A
PS891005-8-8	2.96" 75.3 mm	2.37" 60.3 mm	1.86" 47.2 mm	2.72" 69.2 mm	1.73" 44.0 mm	1.12" 28.6 mm	.88" 22.2 mm	3/4-16 UNF-2B	3/4-16 UNF-2A
PS1291005-12-12	3.43" 87.2 mm	2.77" 70.4 mm	2.40" 61.0 mm	3.49" 88.5 mm	2.17" 55.2 mm	1.38" 35.0 mm	1.25" 31.8 mm	1-1/16-12 UN-2B	1-1/16-12 UN-2A
PS1691005-16-16	4.03" 102.3 mm	3.16" 80.3 mm	2.50" 63.4 mm	3.74" 94.9 mm	2.48" 63.0 mm	1.62" 41.3 mm	1.50" 38.1 mm	1-5/16-12 UN-2B	1-5/16-12 UN-2A

Female SAE Straight Thread - Female 37° Flare

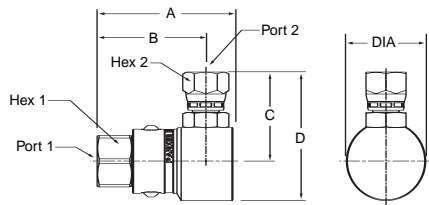

Part Number	A	B	C	D	Dia.	Hex 1	Hex 2	Port 1	Port 2
PS491006-4-4	2.42" 61.4 mm	2.01" 51.2 mm	1.47" 37.3 mm	2.07" 52.5 mm	1.20" 30.5 mm	.75" 19.0 mm	.56" 14.3 mm	7/16-20 UNF-2B	7/16-20 UNF-2B
PS691006-6-6	2.68" 68.2 mm	2.17" 55.2 mm	1.57" 39.9 mm	2.22" 56.3 mm	1.29" 32.8 mm	.88" 22.2 mm	.69" 17.5 mm	9/16-18 UNF-2B	9/16-18 UNF-2B
PS891006-8-8	2.96" 75.3 mm	2.37" 60.3 mm	1.91" 48.4 mm	2.77" 70.4 mm	1.73" 44.0 mm	1.12" 28.6 mm	.88" 22.2 mm	3/4-16 UNF-2B	3/4-16 UNF-2B
PS1291006-12-12	3.43" 87.2 mm	2.77" 70.4 mm	2.34" 59.4 mm	3.43" 87.0 mm	2.17" 55.2 mm	1.38" 35.0 mm	1.25" 31.8 mm	1-1/16-12 UN-2B	1-1/16-12 UN-2B
PS1691006-16-16	4.03" 102.3 mm	3.16" 80.3 mm	2.54" 64.6 mm	3.79" 96.2 mm	2.48" 63.0 mm	1.62" 41.3 mm	1.50" 38.1 mm	1-5/16-12 UN-2B	1-5/16-12 UN-2B

Female SAE Straight Thread - Female NPSM Pipe Swivel

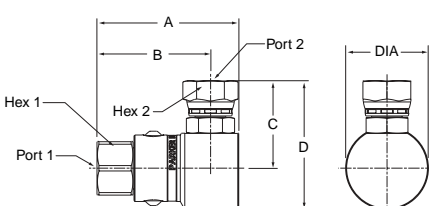

Part Number	A	B	C	D	Dia.	Hex 1	Hex 2	Port 1	Port 2
PS491007-4-4	2.42" 61.4 mm	2.01" 51.2 mm	1.48" 37.5 mm	2.08" 52.8 mm	1.20" 30.5 mm	.75" 19.0 mm	.69" 17.4 mm	7/16-20 UNF-2B	1/4-18 NPSM
PS691007-6-6	2.68" 68.2 mm	2.17" 55.2 mm	1.51" 38.4 mm	2.16" 54.8 mm	1.29" 32.8 mm	.88" 22.2 mm	.88" 22.2 mm	9/16-18 UNF-2B	3/8-18 NPSM
PS891007-8-8	2.96" 75.3 mm	2.37" 60.3 mm	1.86" 47.2 mm	2.72" 69.2 mm	1.73" 44.0 mm	1.12" 28.6 mm	1.00" 25.4 mm	3/4-16 UNF-2B	1/2-14 NPSM
PS1291007-12-12	3.43" 87.2 mm	2.77" 70.4 mm	2.24" 56.9 mm	3.33" 84.5 mm	2.17" 55.2 mm	1.38" 35.0 mm	1.25" 31.8 mm	1-1/16-12 UN-2B	3/4-14 NPSM
PS1691007-16-16	4.03" 102.3 mm	3.16" 80.3 mm	2.48" 63.1 mm	3.73" 94.6 mm	2.48" 63.0 mm	1.62" 41.3 mm	1.50" 38.1 mm	1-5/16-12 UN-2B	1-11/2 NPSM

Female SAE Straight Thread - Female SAE Straight Thread

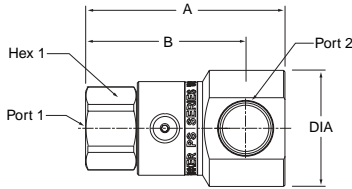

3 Piece Design

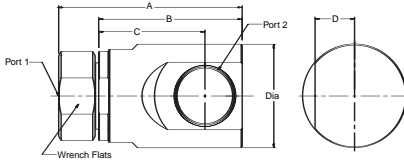

Part Number	A	B	Dia.	Hex 1	Port 1	Port 2
PS491010-4-4	2.42" 61.4 mm	2.01" 51.2 mm	1.20" 30.5 mm	.75" 19.0 mm	7/16-20 UNF-2B	7/16-20 UNF-2B
PS691010-6-6	2.68" 68.2 mm	2.17" 55.2 mm	1.29" 32.8 mm	.88" 22.2 mm	9/16-18 UNF-2B	9/16-18 UNF-2B
PS891010-8-8	2.96" 75.3 mm	2.37" 60.3 mm	1.73" 44.0 mm	1.12" 28.6 mm	3/4-16 UNF-2B	3/4-16 UNF-2B
PS1291010-12-12	3.43" 87.2 mm	2.77" 70.4 mm	2.17" 55.2 mm	1.38" 35.0 mm	1-1/16-12 UN-2B	1-1/16-12 UN-2B
PS1691010-16-16	4.03" 102.3 mm	3.16" 80.3 mm	2.48" 63.0 mm	1.62" 41.3 mm	1-5/16-12 UN-2B	1-5/16-12 UN-2B

Part Number	A	B	C	D	Wrench Flats	Dia.	Port 1	Port 2
PS2491010-20-20	5.91" 150.2 mm	4.63" 117.5 mm	3.43" 87.0 mm	1.27" 32.3 mm	2.63" 66.7 mm	3.36" 85.2 mm	1 5/8-12 UN-2B	1 5/8-12 UN-2B
PS2491010-24-24	5.91" 150.2 mm	4.63" 117.5 mm	3.43" 87.0 mm	1.27" 32.3 mm	2.63" 66.7 mm	3.36" 85.2 mm	1 7/8-12 UN-2B	1 7/8-12 UN-2B
PS3291010-32-32	6.83" 179.8 mm	5.45" 138.4 mm	3.93" 99.7 mm	1.52" 38.5 mm	3.06" 77.6 mm	4.19" 106.4 mm	2 11/16-12 UN-2B	2 1/2-12 UN-2B

Female SAE Straight Thread - O-Ring Face Seal

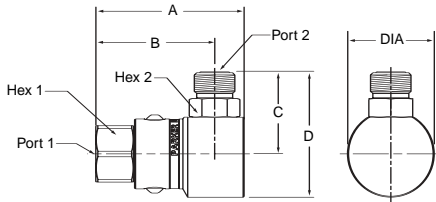

Part Number	A	B	C	D	Dia.	Hex 1	Hex 2	Port 1	Port 2
PS4910JM-4-4	2.42" 61.4 mm	2.01" 51.2 mm	1.29" 32.5 mm	1.89" 47.9 mm	1.20" 30.5 mm	.75" 19.0 mm	.56" 14.3 mm	7/16-20 UNF-2B	9/16-18 UNF-2A
PS6910JM-6-6	2.68" 68.2 mm	2.17" 55.2 mm	1.40" 35.6 mm	2.05" 52.0 mm	1.29" 32.8 mm	.88" 22.2 mm	.69" 17.5 mm	9/16-18 UNF-2B	11/16-16 UNF-2A
PS8910JM-8-8	2.96" 75.3 mm	2.37" 60.3 mm	1.74" 44.1 mm	2.60" 66.1 mm	1.73" 44.0 mm	1.12" 28.6 mm	.88" 22.2 mm	3/4-16 UNF-2B	13/16-16 UN-2A
PS12910JM-12-12	3.43" 87.2 mm	2.77" 70.4 mm	2.18" 55.4 mm	3.27" 83.0 mm	2.17" 55.2 mm	1.38" 35.0 mm	1.25" 31.8 mm	1-1/16-12 UN-2B	1-3/16-12 UN-2A
PS16910JM-16-16	4.03" 102.3 mm	3.16" 80.3 mm	2.34" 59.6 mm	3.59" 91.1 mm	2.48" 63.0 mm	1.62" 41.3 mm	1.50" 38.1 mm	1-5/16-12 UN-2B	1-7/16-12 UN-2A

O-Ring Face Seal - Female Pipe

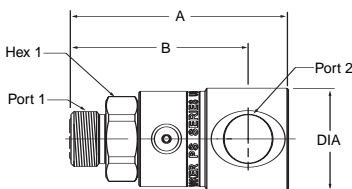

Part Number	A	B	Dia.	Hex 1	Port 1	Port 2
PS49JM02-4-4	2.70" 68.6 mm	2.29" 58.3 mm	1.20" 30.5 mm	.75" 19.0 mm	9/16-18 UNF-2A	1/4-18 NPTF
PS69JM02-6-6	2.87" 72.8 mm	2.36" 59.8 mm	1.29" 32.8 mm	.88" 22.2 mm	11/16-16 UN-2A	3/8-18 NPTF
PS89JM02-8-8	3.19" 80.9 mm	2.60" 65.9 mm	1.49" 37.8 mm	1.12" 28.6 mm	13/16-16 UN-2A	1/2-14 NPTF
PS129JM02-12-12	3.58" 90.9 mm	2.92" 74.0 mm	1.76" 44.6 mm	1.38" 35.0 mm	1-3/16-12 UN-2A	3/4-14 NPTF
PS169JM02-16-16	4.18" 106.3 mm	3.32" 84.3 mm	2.16" 54.9 mm	1.62" 41.3 mm	1-7/16-12 UN-2A	1-11/16-12 NPTF

O-Ring Face Seal - Male 37° Flare

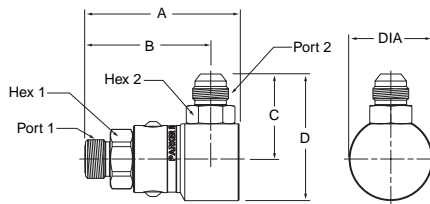

Part Number	A	B	C	D	Dia.	Hex 1	Hex 2	Port 1	Port 2
PS49JM03-4-4	2.70" 68.6 mm	2.29" 58.3 mm	1.39" 35.2 mm	1.99" 50.5 mm	1.20" 30.5 mm	.75" 19.0 mm	.56" 14.3 mm	9/16-18 UNF-2A	7/16-20 UNF-2A
PS69JM03-6-6	2.87" 72.8 mm	2.36" 59.8 mm	1.44" 36.6 mm	2.09" 53.0 mm	1.29" 32.8 mm	.88" 22.2 mm	.69" 17.5 mm	11/16-16 UN-2A	9/16-18 UNF-2A
PS89JM03-8-8	3.19" 80.9 mm	2.60" 65.9 mm	1.78" 45.1 mm	2.64" 67.1 mm	1.73" 44.0 mm	1.12" 28.6 mm	.88" 22.2 mm	13/16-16 UN-2A	3/4-16 UNF-2A
PS89JM03-10-10	3.29" 83.5 mm	2.70" 68.5 mm	1.90" 48.4 mm	2.77" 70.4 mm	1.73" 44.0 mm	1.12" 28.6 mm	.88" 22.2 mm	7/8-14 UN-2A	7/8-14 UNF-2A
PS129JM03-12-12	3.58" 90.9 mm	2.92" 74.0 mm	2.24" 56.9 mm	3.86" 85.3 mm	2.17" 55.2 mm	1.38" 35.0 mm	1.25" 31.8 mm	1-3/16-12 UN-2A	1-1/16-12 UN-2A
PS169JM03-16-16	4.18" 106.3 mm	3.32" 84.3 mm	2.42" 61.3 mm	3.66" 92.9 mm	2.48" 63.0 mm	1.62" 41.3 mm	1.50" 38.1 mm	1-7/16-12 UN-2A	1-5/16-12 UN-2A

O-Ring Face Seal - Male SAE O-Ring Straight Thread

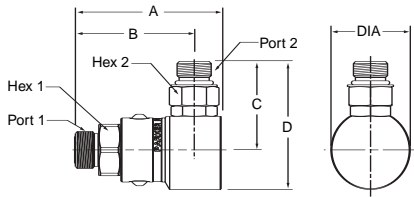

Part Number	A	B	C	D	Dia.	Hex 1	Hex 2	Port 1	Port 2
PS49JM05-4-4	2.70" 68.6 mm	2.29" 58.3 mm	1.38" 35.0 mm	1.98" 50.2 mm	1.20" 30.5 mm	.75" 19.0 mm	.56" 14.3 mm	9/16-18 UNF-2A	7/16-20 UNF-2A
PS69JM05-6-6	2.87" 72.8 mm	2.36" 59.8 mm	1.55" 39.4 mm	2.20" 55.8 mm	1.29" 32.8 mm	.88" 22.2 mm	.69" 17.5 mm	11/16-16 UN-2A	9/16-18 UNF-2A
PS89JM05-8-8	3.19" 80.9 mm	2.60" 65.9 mm	1.86" 47.2 mm	2.72" 69.2 mm	1.73" 44.0 mm	1.12" 28.6 mm	.88" 22.2 mm	13/16-16 UN-2A	3/4-16 UNF-2A
PS129JM05-12-12	3.58" 90.9 mm	2.92" 74.0 mm	2.40" 61.0 mm	3.49" 88.5 mm	2.17" 55.2 mm	1.38" 35.0 mm	1.25" 31.8 mm	1-3/16-12 UN-2A	3/4-12 UN-2A
PS169JM05-16-16	4.18" 106.3 mm	3.32" 84.3 mm	2.50" 63.4 mm	3.74" 94.9 mm	2.48" 63.0 mm	1.62" 41.3 mm	1.50" 38.1 mm	1-7/16-12 UN-2A	1-5/16-12 UN-2A

O-Ring Face Seal - Female 37° Flare

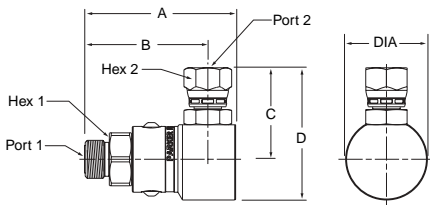

Part Number	A	B	C	D	Dia.	Hex 1	Hex 2	Port 1	Port 2
PS49JM06-4-4	2.70" 68.6 mm	2.29" 58.3 mm	1.47" 37.3 mm	2.07" 52.5 mm	1.20" 30.5 mm	.75" 19.0 mm	.56" 14.3 mm	9/16-18 UNF-2A	7/16-20 UNF-2B
PS69JM06-6-6	2.87" 72.8 mm	2.36" 59.8 mm	1.57" 39.9 mm	2.22" 56.3 mm	1.29" 32.8 mm	.88" 22.2 mm	.69" 17.5 mm	11/16-16 UN-2A	9/16-18 UNF-2B
PS89JM06-8-8	3.19" 80.9 mm	2.60" 65.9 mm	1.91" 48.4 mm	2.77" 70.4 mm	1.73" 44.0 mm	1.12" 28.6 mm	.88" 22.2 mm	13/16-16 UN-2A	3/4-16 UNF-2B
PS129JM06-12-12	3.58" 90.9 mm	2.92" 74.0 mm	2.34" 59.4 mm	3.43" 87.0 mm	2.17" 55.2 mm	1.38" 35.0 mm	1.25" 31.8 mm	1-3/16-12 UN-2A	1-1/16-12 UN-2B
PS169JM06-16-16	4.18" 106.3 mm	3.32" 84.3 mm	2.54" 64.6 mm	3.79" 96.2 mm	2.48" 63.0 mm	1.62" 41.3 mm	1.50" 38.1 mm	1-7/16-12 UN-2A	1-5/16-12 UN-2B

O-Ring Face Seal - Female NPSM Pipe Swivel

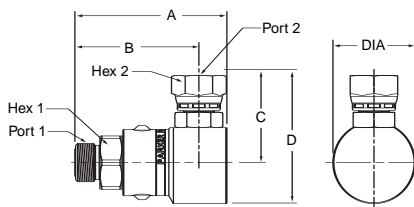

Part Number	A	B	C	D	Dia.	Hex 1	Hex 2	Port 1	Port 2
PS49JM07-4-4	2.70" 68.6 mm	2.29" 58.3 mm	1.48" 37.5 mm	2.08" 52.8 mm	1.20" 30.5 mm	.75" 19.0 mm	.69" 17.4 mm	9/16-18 UNF-2A	1/4-18 NPSM
PS69JM07-6-6	2.87" 72.8 mm	2.36" 59.8 mm	1.51" 38.4 mm	2.16" 54.8 mm	1.29" 32.8 mm	.88" 22.2 mm	.88" 22.2 mm	11/16-16 UN-2A	3/8-18 NPSM
PS89JM07-8-8	3.19" 80.9 mm	2.60" 65.9 mm	1.86" 47.2 mm	2.72" 69.2 mm	1.73" 44.0 mm	1.12" 28.6 mm	1.00" 25.4 mm	13/16-16 UN-2A	1/2-14 NPSM
PS129JM07-12-12	3.58" 90.9 mm	2.92" 74.0 mm	2.24" 56.9 mm	3.33" 84.5 mm	2.17" 55.2 mm	1.38" 35.0 mm	1.25" 31.8 mm	1-3/16-12 UN-2A	3/4-14 NPSM
PS169JM07-16-16	4.18" 106.3 mm	3.32" 84.3 mm	2.48" 63.1 mm	3.73" 94.6 mm	2.48" 63.0 mm	1.62" 41.3 mm	1.50" 38.1 mm	1-7/16-12 UN-2A	1-11/2 NPSM

O-Ring Face Seal - Female SAE Straight Thread

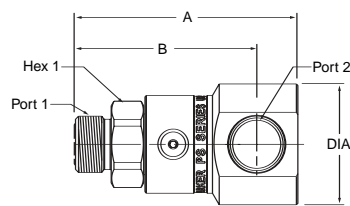

Part Number	A	B	Dia.	Hex 1	Port 1	Port 2
PS49JM10-4-4	2.70" 68.6 mm	2.29" 58.3 mm	1.20" 30.5 mm	.75" 19.0 mm	9/16-18 UNF-2A	7/16-20 UNF-2B
PS69JM10-6-6	2.87" 72.8 mm	2.36" 59.8 mm	1.29" 32.8 mm	.88" 22.2 mm	11/16-16 UN-2A	9/16-18 UNF-2B
PS89JM10-8-8	3.19" 80.9 mm	2.60" 65.9 mm	1.73" 44.0 mm	1.12" 28.6 mm	13/16-16 UN-2A	3/4-16 UNF-2B
PS129JM10-12-12	3.58" 90.9 mm	2.92" 74.0 mm	2.17" 55.2 mm	1.38" 35.0 mm	1-3/16-12 UN-2A	1-1/16-12 UN-2B
PS169JM10-16-16	4.18" 106.3 mm	3.32" 84.3 mm	2.48" 63.0 mm	1.62" 41.3 mm	1-7/16-12 UN-2A	1-5/16-12 UN-2B

O-Ring Face Seal - O-Ring Face Seal

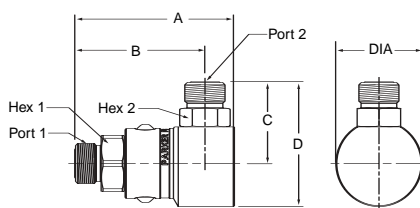

Part Number	A	B	C	D	Dia.	Hex 1	Hex 2	Port 1	Port 2
PS49JMJM-4-4	2.70" 68.6 mm	2.29" 58.3 mm	1.29" 32.5 mm	1.89" 47.9 mm	1.20" 30.5 mm	.75" 19.0 mm	.56" 14.3 mm	9/16-18 UNF-2A	9/16-18 UNF-2A
PS69JMJM-6-6	2.87" 72.8 mm	2.36" 59.8 mm	1.40" 35.6 mm	2.05" 52.0 mm	1.29" 32.8 mm	.88" 22.2 mm	.69" 17.5 mm	11/16-16 UN-2A	11/16-16 UN-2A
PS89JMJM-8-8	3.19" 80.9 mm	2.60" 65.9 mm	1.74" 44.1 mm	2.60" 66.1 mm	1.73" 44.0 mm	1.12" 28.6 mm	.88" 22.2 mm	13/16-16 UN-2A	13/16-16 UN-2A
PS89JMJM-10-10	3.29" 83.5 mm	2.70" 68.5 mm	1.96" 49.9 mm	2.83" 71.9 mm	1.73" 44.0 mm	1.12" 28.6 mm	.88" 22.2 mm	1-14 UN-2A	1-14 UN-2A
PS129JMJM-12-12	3.58" 90.9 mm	2.92" 74.0 mm	2.18" 55.4 mm	3.27" 83.0 mm	2.17" 55.2 mm	1.38" 35.0 mm	1.25" 31.8 mm	1-3/16-12 UN-2A	1-3/16-12 UN-2A
PS169JMJM-16-16	4.18" 106.3 mm	3.32" 84.3 mm	2.34" 59.6 mm	3.59" 91.1 mm	2.48" 63.0 mm	1.62" 41.3 mm	1.50" 38.1 mm	1-7/16-12 UN-2A	1-7/16-12 UN-2A

Repair Kits

Swivels

Repair Kits/Seal Options

Repair Kits come complete with O-Rings, PTFE Back-Up Ring, Cap Screws, Locking Balls, Retaining Ring and grease fitting. Repair kits are suitable for both current and previous design 90° PS Series Swivels.

1/4" Swivel	3/8" Swivel	1/2" Swivel	3/4" Swivel	1" Swivel
PS4-RPR	PS6-RPR	PS8-RPR	PS12-RPR	PS16-RPR
PS4Y-RPR	PS6Y-RPR	PS8Y-RPR	PS12Y-RPR	PS16Y-RPR
PS4A-RPR	PS6A-RPR	PS8A-RPR	PS12A-RPR	PS16A-RPR
PS4W-RPR	PS6W-RPR	PS8W-RPR	PS12W-RPR	PS16W-RPR

H2C-PS = Bearing Removal Pneumatic Nipple

Seal Options

Nitrile (*standard unless otherwise designated*)

A = Aflas™

W = Ethylene Propylene

Y = Fluorocarbon

Z = Neoprene

For **Perfluoroelastomer** seal option contact the division.

S Series Swivels

Introduction

The S Series Swivel product line complements the Quick Coupling Division's PS Series swivel line by offering a pressure balanced, compact forged body design. As a result of the pressure balanced design, the S Series Swivel does not experience a significant increase in torque as pressure rises. The housing body is forged to provide superior performance and durability in tough applications. This product is great for eliminating hose twist, torque and stress caused by the movement of the hydraulic components where side load to the swivel can be minimized.



Features

- 3000 psi working pressure rating for all sizes.
- Variety of seal options.
- Torque value does not significantly increase with pressure.
- Dust seals protect the swivel from damaging environmental contaminants.
- Field service kits are available for quick and reliable repairs.
- 360° swivel eliminates long radius bends, hose twist and stress that can cause premature hose failure.
- One piece forged housing eliminates a brazed 90° adapter connection.
- Case hardened for enhanced service life.
- Compact design to fit into tight areas.

Specifications

Body size	1/4"	3/8"	1/2"	3/4"	1"
Maximum Rated Pressure (PSI)	3000	3000	3000	3000	3000*
Temperature Range (standard seals)	-40° to 250° F				

* 07 ports on 1" S Series maximum rated pressure is 2600 psi.

Performance Data

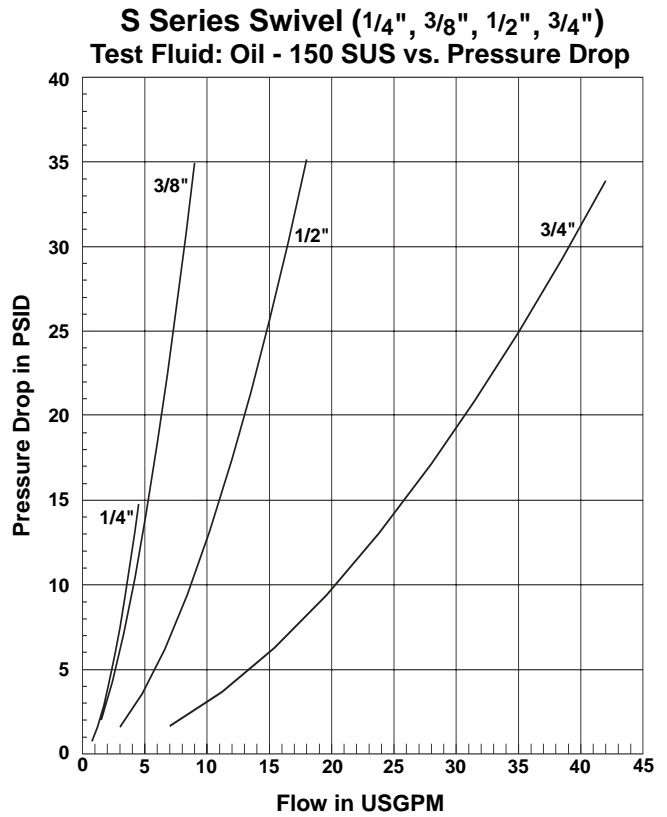

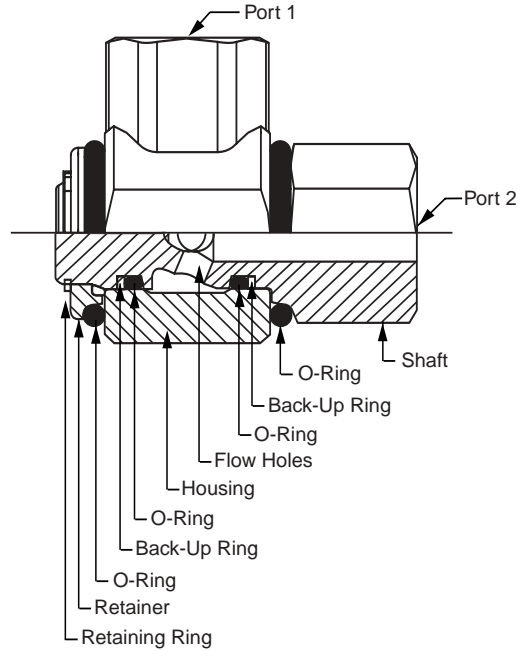

S Part Number:

S 21 02 V - 8 - 8 NI

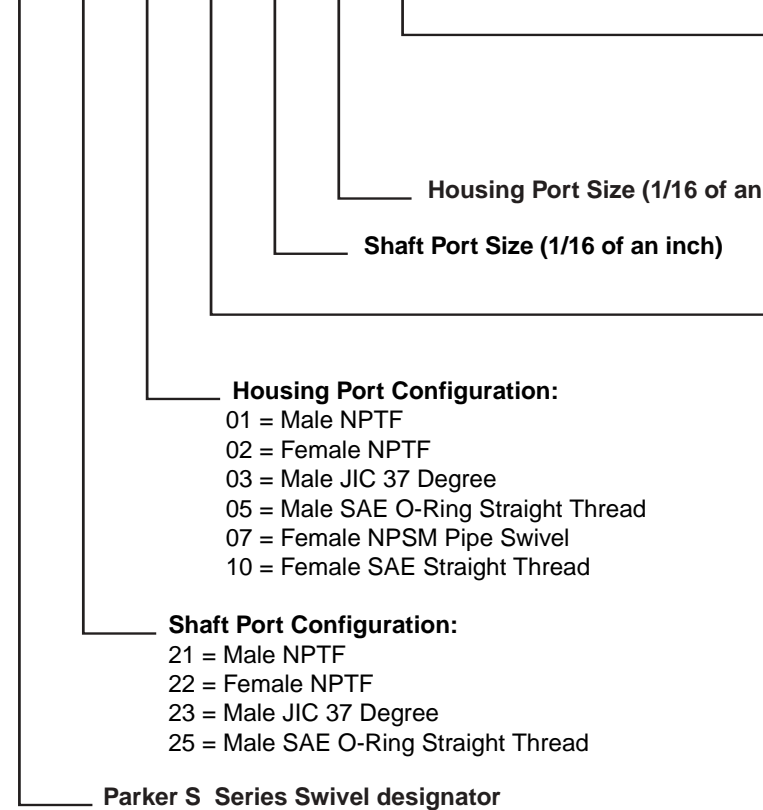

Material and Finish:

Blank = Carbon Steel (12L14)
Yellow Chromate Plating
NI = Carbon Steel (12L14)*
Nickel Plating

Seal Code:

Blank = Nitrile (Standard)
E = Ethylene Propylene
V = Fluorocarbon

Housing Port Configuration:

- 01 = Male NPTF
- 02 = Female NPTF
- 03 = Male JIC 37 Degree
- 05 = Male SAE O-Ring Straight Thread
- 07 = Female NPSM Pipe Swivel
- 10 = Female SAE Straight Thread

Shaft Port Configuration:

- 21 = Male NPTF
- 22 = Female NPTF
- 23 = Male JIC 37 Degree
- 25 = Male SAE O-Ring Straight Thread

Parker S Series Swivel designator

* Contact the Division for Price and Availability

Male Pipe - Male Pipe

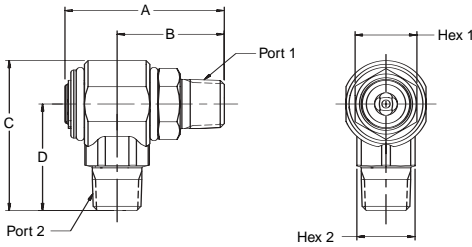

Part Number	A	B	C	D	HEX 1	HEX 2	PORT 1	PORT 2
S2101-4-4	2.31" 58.7 mm	1.51" 38.4 mm	2.19" 55.5 mm	1.50" 38.0 mm	.88" 22.2 mm	.88" 22.2 mm	1/4-18 NPTF	1/4-18 NPTF
S2101-6-6	2.31" 58.7 mm	1.51" 38.4 mm	2.19" 55.5 mm	1.50" 38.0 mm	.88" 22.2 mm	.88" 22.2 mm	3/8-18 NPTF	3/8-18 NPTF
S2101-8-8	2.74" 69.6 mm	1.84" 46.8 mm	2.59" 65.8 mm	1.84" 46.7 mm	1.06" 27.0 mm	1.00" 25.4 mm	1/2-14 NPTF	1/2-14 NPTF
S2101-12-12	3.35" 85.1 mm	2.12" 53.9 mm	3.00" 76.2 mm	2.11" 53.5 mm	1.38" 34.9 mm	1.38" 34.9 mm	3/4-14 NPTF	3/4-14 NPTF

Male Pipe - Female Pipe

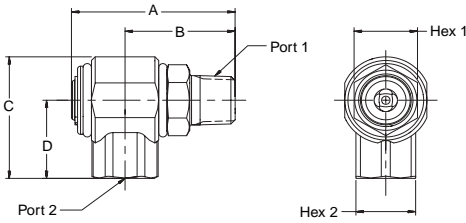

Part Number	A	B	C	D	HEX 1	HEX 2	PORT 1	PORT 2
S2102-4-4	2.31" 58.7 mm	1.51" 38.4 mm	1.78" 45.1 mm	1.09" 27.6 mm	.88" 22.2 mm	.88" 22.2 mm	1/4-18 NPTF	1/4-18 NPTF
S2102-6-6	2.31" 58.7 mm	1.51" 38.4 mm	1.78" 45.1 mm	1.09" 27.6 mm	.88" 22.2 mm	.88" 22.2 mm	3/8-18 NPTF	3/8-18 NPTF
S2102-8-8	2.74" 69.6 mm	1.84" 46.8 mm	2.10" 53.3 mm	1.35" 34.3 mm	1.06" 27.0 mm	1.00" 25.4 mm	1/2-14 NPTF	1/2-14 NPTF
S2102-12-12	3.35" 85.1 mm	2.12" 53.9 mm	2.39" 60.7 mm	1.50" 38.0 mm	1.38" 34.9 mm	1.38" 34.9 mm	3/4-14 NPTF	3/4-14 NPTF

Male Pipe - Male 37° Flare

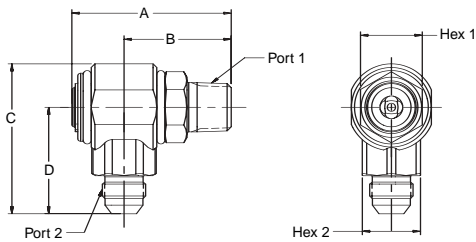

Part Number	A	B	C	D	HEX 1	HEX 2	PORT 1	PORT 2
S2103-4-4	2.31" 58.7 mm	1.51" 38.4 mm	2.19" 55.5 mm	1.50" 38.0 mm	.88" 22.2 mm	.88" 22.2 mm	1/4-18 NPTF	7/16-20UNF-2A
S2103-6-6	2.31" 58.7 mm	1.51" 38.4 mm	2.19" 55.5 mm	1.50" 38.0 mm	.88" 22.2 mm	.88" 22.2 mm	3/8-18 NPTF	9/16-18UNF-2A
S2103-8-8	2.74" 69.6 mm	1.84" 46.8 mm	2.59" 65.8 mm	1.84" 46.7 mm	1.06" 27.0 mm	1.00" 25.4 mm	1/2-14 NPTF	3/4-16UNF-2A
S2103-12-12	3.35" 85.1 mm	2.12" 53.9 mm	3.07" 77.9 mm	2.17" 55.2 mm	1.38" 34.9 mm	1.38" 34.9 mm	3/4-14 NPTF	1-1/16-12UN-2A
S2103-16-16	3.95" 100.33 mm	2.54" 64.5 mm	3.01" 76.5 mm	2.11" 53.6 mm	1.63" 41.4 mm	1.69" 42.9 mm	1-11 1/2 NPTF	1-5/16-12UN-2A

Male Pipe - Female NPSM Pipe Swivel

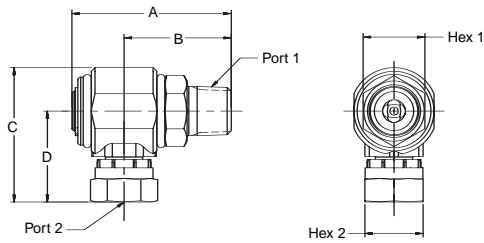

Part Number	A	B	C	D	HEX 1	HEX 2	PORT 1	PORT 2
S2107-4-4	2.31" 58.7 mm	1.51" 38.4 mm	2.05" 52.0 mm	1.36" 34.5 mm	.88" 22.2 mm	.69" 17.5 mm	1/4-18 NPTF	1/4-18 NPSM
S2107-6-6	2.31" 58.7 mm	1.51" 38.4 mm	2.07" 52.5 mm	1.38" 35.1 mm	.88" 22.2 mm	.88" 22.2 mm	3/8-18 NPTF	3/8-18 NPSM
S2107-8-8	2.74" 69.6 mm	1.84" 46.8 mm	2.32" 59.0 mm	1.57" 39.9 mm	1.06" 27.0 mm	1.00" 25.4 mm	1/2-14 NPTF	1/2-14 NPSM
S2107-12-12	3.35" 85.1 mm	2.12" 53.9 mm	2.74" 69.5 mm	1.85" 46.9 mm	1.38" 34.9 mm	1.25" 31.8 mm	3/4-14 NPTF	3/4-14 NPSM
S2107-16-16	3.95" 100.3 mm	2.54" 64.5 mm	3.14" 79.8 mm	2.23" 56.6 mm	1.63" 41.4 mm	1.69" 42.9 mm	1-11 1/2 NPTF	1-11 1/2 NPSM

Male Pipe - Female SAE Straight Thread

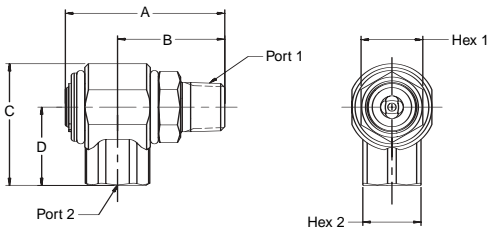

Part Number	A	B	C	D	HEX 1	HEX 2	PORT 1	PORT 2
S2110-6-6	2.31" 58.7 mm	1.51" 38.4 mm	1.78" 45.1 mm	1.09" 27.6 mm	.88" 22.2 mm	.88" 22.2 mm	3/8-18 NPTF	9/16-18UNF-2B
S2110-8-8	2.74" 69.6 mm	1.84" 46.8 mm	2.10" 53.3 mm	1.35" 34.3 mm	1.06" 27.0 mm	1.00" 25.4 mm	1/2-14 NPTF	3/4-16UNF-2B
S2110-12-12	3.35" 85.1 mm	2.12" 53.9 mm	2.54" 64.5 mm	1.65" 41.9 mm	1.38" 34.9 mm	1.38" 34.9 mm	3/4-14 NPTF	1-1/16-12UN-2B

Female Pipe - Male Pipe

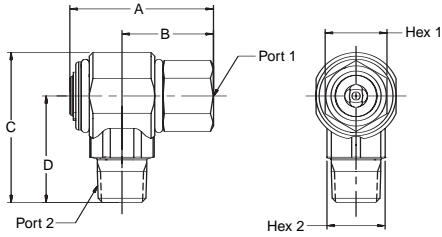

Part Number	A	B	C	D	HEX 1	HEX 2	PORT 1	PORT 2
S2201-4-4	2.19" 55.6 mm	1.39" 35.4 mm	2.19" 55.5 mm	1.50" 38.0 mm	.88" 22.2 mm	.88" 22.2 mm	1/4-18 NPTF	1/4-18 NPTF
S2201-6-6	2.19" 55.6 mm	1.39" 35.4 mm	2.19" 55.5 mm	1.50" 38.0 mm	.88" 22.2 mm	.88" 22.2 mm	3/8-18 NPTF	3/8-18 NPTF
S2201-8-8	2.47" 62.7 mm	1.57" 40.0 mm	2.59" 65.8 mm	1.84" 46.7 mm	1.06" 27.0 mm	1.00" 25.4 mm	1/2-14 NPTF	1/2-14 NPTF
S2201-12-12	3.15" 80.0 mm	1.92" 48.8 mm	3.00" 76.2 mm	2.11" 53.5 mm	1.38" 34.9 mm	1.38" 34.9 mm	3/4-14 NPTF	3/4-14 NPTF

Female Pipe - Female Pipe

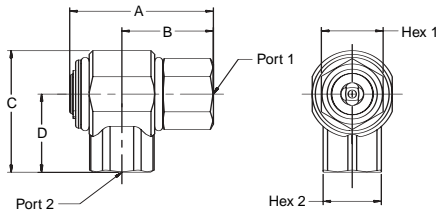

Part Number	A	B	C	D	HEX 1	HEX 2	PORT 1	PORT 2
S2202-4-4	2.19" 55.6 mm	1.39" 35.4 mm	1.78" 45.1 mm	1.09" 27.6 mm	.88" 22.2 mm	.88" 22.2 mm	1/4-18 NPTF	1/4-18 NPTF
S2202-6-6	2.19" 55.6 mm	1.39" 35.4 mm	1.78" 45.1 mm	1.09" 27.6 mm	.88" 22.2 mm	.88" 22.2 mm	3/8-18 NPTF	3/8-18 NPTF
S2202-8-8	2.47" 62.7 mm	1.57" 40.0 mm	2.10" 53.3 mm	1.35" 34.3 mm	1.06" 27.0 mm	1.00" 25.4 mm	1/2-14 NPTF	1/2-14 NPTF
S2202-12-12	3.15" 80.0 mm	1.92" 48.8 mm	2.39" 60.7 mm	1.50" 38.0 mm	1.38" 34.9 mm	1.38" 34.9 mm	3/4-14 NPTF	3/4-14 NPTF

Female Pipe - Male 37° Flare

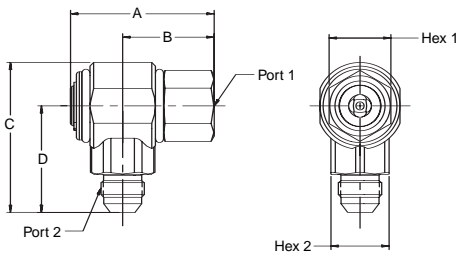

Part Number	A	B	C	D	HEX 1	HEX 2	PORT 1	PORT 2
S2203-4-4	2.19" 55.6 mm	1.39" 35.4 mm	2.19" 55.5 mm	1.50" 38.0 mm	.88" 22.2 mm	.88" 22.2 mm	1/4-18 NPTF	7/16-20UNF-2A
S2203-6-6	2.19" 55.6 mm	1.39" 35.4 mm	2.19" 55.5 mm	1.50" 38.0 mm	.88" 22.2 mm	.88" 22.2 mm	3/8-18 NPTF	9/16-18UNF-2A
S2203-8-8	2.47" 62.7 mm	1.57" 40.0 mm	2.59" 65.8 mm	1.84" 46.7 mm	1.06" 27.0 mm	1.00" 25.4 mm	1/2-14 NPTF	3/4-16UNF-2A
S2203-12-12	3.15" 80.0 mm	1.92" 48.8 mm	3.07" 77.9 mm	2.17" 55.2 mm	1.38" 34.9 mm	1.38" 34.9 mm	3/4-14 NPTF	1-1/16-12UN-2A
S2203-16-16	3.55" 90.2 mm	2.13" 54.1 mm	3.01" 76.5 mm	2.11" 53.6 mm	1.63" 41.4 mm	1.69" 42.9 mm	1-11 1/2 NPTF	1-5/16-12UN-2A

Female Pipe - Female SAE Straight Thread

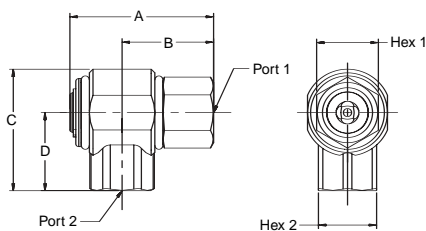

Part Number	A	B	C	D	HEX 1	HEX 2	PORT 1	PORT 2
S2210-6-6	2.19" 55.6 mm	1.39" 35.4 mm	1.78" 45.1 mm	1.09" 27.6 mm	.88" 22.2 mm	.88" 22.2 mm	3/8-18 NPTF	9/16-18UNF-2B
S2210-8-8	2.47" 62.7 mm	1.57" 40.0 mm	2.10" 53.3 mm	1.35" 34.3 mm	1.06" 27.0 mm	1.00" 25.4 mm	1/2-14 NPTF	3/4-16UNF-2B
S2210-12-12	3.15" 80.0 mm	1.92" 48.8 mm	2.54" 64.5 mm	1.65" 41.9 mm	1.38" 34.9 mm	1.38" 34.9 mm	3/4-14 NPTF	1-1/16-12UN-2B

Female Pipe - Female NPSM Pipe Swivel

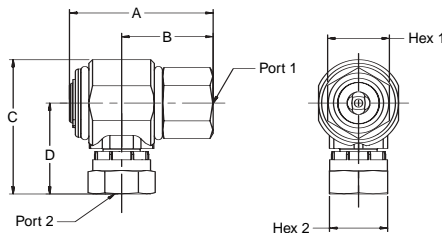

Part Number	A	B	C	D	HEX 1	HEX 2	PORT 1	PORT 2
S2207-4-4	2.19" 55.6 mm	1.39" 35.4 mm	2.05" 52.0 mm	1.36" 34.5 mm	.88" 22.2 mm	.69" 17.5 mm	1/4-18 NPTF	1/4-18 NPSM
S2207-6-6	2.19" 55.6 mm	1.39" 35.4 mm	2.07" 52.5 mm	1.38" 35.1 mm	.88" 22.2 mm	.88" 22.2 mm	3/8-18 NPTF	3/8-18 NPSM
S2207-8-8	2.47" 62.7 mm	1.57" 40.0 mm	2.32" 59.0 mm	1.57" 39.9 mm	1.06" 27.0 mm	1.00" 25.4 mm	1/2-14 NPTF	1/2-14 NPSM
S2207-12-12	3.15" 80.0 mm	1.92" 48.8 mm	2.74" 69.5 mm	1.85" 46.9 mm	1.38" 34.9 mm	1.25" 31.8 mm	3/4-14 NPTF	3/4-14 NPSM
S2207-16-16	3.55" 90.2 mm	2.13" 54.1 mm	3.14" 79.8 mm	2.23" 56.6 mm	1.63" 41.4 mm	1.69" 42.9 mm	1-11 1/2 NPTF	1-11 1/2 NPSM

D Swivels

Male 37° Flare - Male Pipe

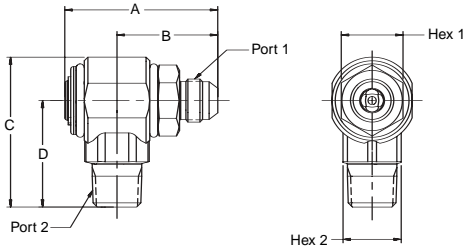

Part Number	A	B	C	D	HEX 1	HEX 2	PORT 1	PORT 2
S2301-4-4	2.41" 61.2 mm	1.61" 40.9 mm	2.19" 55.5 mm	1.50" 38.0 mm	.88" 22.2 mm	.88" 22.2 mm	7/16-20UNF-2A	1/4-18 NPTF
S2301-6-6	2.41" 61.2 mm	1.61" 40.9 mm	2.19" 55.5 mm	1.50" 38.0 mm	.88" 22.2 mm	.88" 22.2 mm	9/16-18UNF-2A	3/8-18 NPTF
S2301-8-8	2.63" 66.8 mm	1.73" 44.0 mm	2.59" 65.8 mm	1.84" 46.7 mm	1.06" 27.0 mm	1.00" 25.4 mm	3/4-16UNF-2A	1/2-14 NPTF
S2301-12-12	3.33" 84.6 mm	2.10" 53.4 mm	3.00" 76.2 mm	2.11" 53.5 mm	1.38" 34.9 mm	1.38" 34.9 mm	1-1/16-12UN-2A	3/4-14 NPTF

Male 37° Flare - Female Pipe

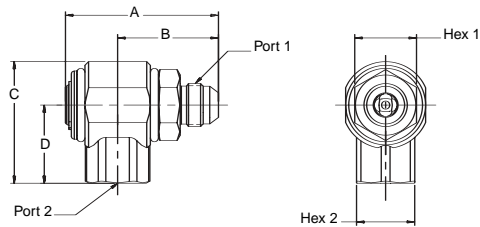

Part Number	A	B	C	D	HEX 1	HEX 2	PORT 1	PORT 2
S2302-4-4	2.41" 61.2 mm	1.61" 40.9 mm	1.78" 45.1 mm	1.09" 27.6 mm	.88" 22.2 mm	.88" 22.2 mm	7/16-20UNF-2A	1/4-18 NPTF
S2302-6-6	2.41" 61.2 mm	1.61" 40.9 mm	1.78" 45.1 mm	1.09" 27.6 mm	.88" 22.2 mm	.88" 22.2 mm	9/16-18UNF-2A	3/8-18 NPTF
S2302-8-8	2.63" 66.8 mm	1.73" 44.0 mm	2.10" 53.3 mm	1.35" 34.3 mm	1.06" 27.0 mm	1.00" 25.4 mm	3/4-16UNF-2A	1/2-14 NPTF
S2302-12-12	3.33" 84.6 mm	2.10" 53.4 mm	2.39" 60.7 mm	1.50" 38.0 mm	1.38" 34.9 mm	1.38" 34.9 mm	1-1/16-12UN-2A	3/4-14 NPTF

Male 37° Flare - Male 37° Flare

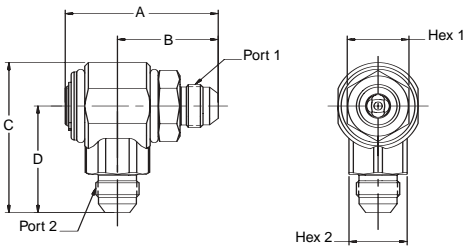

Part Number	A	B	C	D	HEX 1	HEX 2	PORT 1	PORT 2
S2303-4-4	2.41" 61.2 mm	1.61" 40.9 mm	2.19" 55.5 mm	1.50" 38.0 mm	.88" 22.2 mm	.88" 22.2 mm	7/16-20UNF-2A	7/16-20UNF-2A
S2303-6-6	2.41" 61.2 mm	1.61" 40.9 mm	2.19" 55.5 mm	1.50" 38.0 mm	.88" 22.2 mm	.88" 22.2 mm	9/16-18UNF-2A	9/16-18UNF-2A
S2303-8-8	2.63" 66.8 mm	1.73" 44.0 mm	2.59" 65.8 mm	1.84" 46.7 mm	1.06" 27.0 mm	1.00" 25.4 mm	3/4-16UNF-2A	3/4-16UNF-2A
S2303-10-10	2.63" 66.8 mm	1.73" 44.0 mm	2.59" 65.8 mm	1.84" 46.7 mm	1.06" 27.0 mm	1.00" 25.4 mm	7/8-14UNF-2A	7/8-14UNF-2A
S2303-12-12	3.33" 84.6 mm	2.10" 53.4 mm	3.07" 77.9 mm	2.17" 55.2 mm	1.38" 34.9 mm	1.38" 34.9 mm	1-1/16-12UN-2A	1-1/16-12UN-2A
S2303-16-16	4.05" 102.9 mm	2.64" 67.1 mm	3.01" 76.5 mm	2.11" 53.6 mm	1.63" 41.4 mm	1.69" 42.9 mm	1-5/16-12UN-2A	1-5/16-12UN-2A

Male 37° Flare - Female NPSM Pipe Swivel

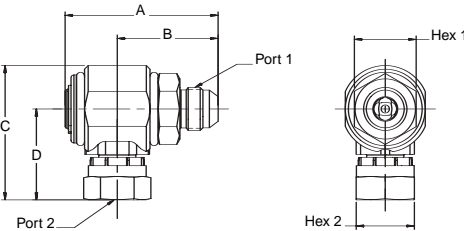

Part Number	A	B	C	D	HEX 1	HEX 2	PORT 1	PORT 2
S2307-4-4	2.41" 61.2 mm	1.61" 40.9 mm	2.05" 52.0 mm	1.36" 34.5 mm	.88" 22.2 mm	.69" 17.5 mm	7/16-20UNF-2A	1/4-18 NPSM
S2307-6-6	2.41" 61.2 mm	1.61" 40.9 mm	2.07" 52.5 mm	1.38" 35.1 mm	.88" 22.2 mm	.88" 22.2 mm	9/16-18UNF-2A	3/8-18 NPSM
S2307-8-8	2.63" 66.8 mm	1.73" 44.0 mm	2.32" 59.0 mm	1.57" 39.9 mm	1.06" 27.0 mm	1.00" 25.4 mm	3/4-16UNF-2A	1/2-14 NPSM
S2307-12-12	3.33" 84.6 mm	2.10" 53.4 mm	2.74" 69.5 mm	1.85" 46.9 mm	1.38" 34.9 mm	1.25" 31.8 mm	1-1/16-12UN-2A	3/4-14 NPSM

Male 37° Flare - Female SAE Straight Thread

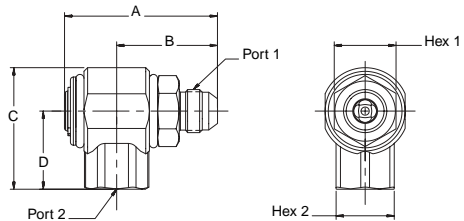

Part number	A	B	C	D	HEX 1	HEX 2	PORT 1	PORT 2
S2310-6-6	2.41" 61.2 mm	1.61" 40.9 mm	1.78" 45.1 mm	1.09" 27.6 mm	.88" 22.2 mm	.88" 22.2 mm	9/16-18UNF-2A	9/16-18UNF-2B
S2310-8-8	2.63" 66.8 mm	1.73" 44.0 mm	2.10" 53.3 mm	1.35" 34.3 mm	1.06" 27.0 mm	1.00" 25.4 mm	3/4-16UNF-2A	3/4-16UNF-2B
S2310-12-12	3.33" 84.6 mm	2.10" 53.4 mm	2.54" 64.5 mm	1.65" 41.9 mm	1.38" 34.9 mm	1.38" 34.9 mm	1-1/16-12UN-2A	1-1/16-12UN-2B

Male SAE O-Ring Straight Thread - Male Pipe

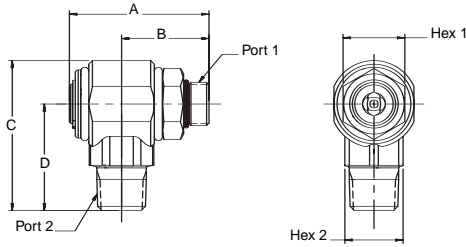

Part number	A	B	C	D	HEX 1	HEX 2	PORT 1	PORT 2
S2501-6-6	2.13" 54.1 mm	1.33" 33.8 mm	2.19" 55.5 mm	1.50" 38.0 mm	.88" 22.2 mm	.88" 22.2 mm	9/16-18UNF-2A	3/8-18 NPTF
S2501-8-8	2.40" 61.0 mm	1.50" 38.2 mm	2.59" 65.8 mm	1.84" 46.7 mm	1.06" 27.0 mm	1.00" 25.4 mm	3/4-16UNF-2A	1/2-14 NPTF
S2501-12-12	3.40" 86.4 mm	2.17" 55.2 mm	3.00" 76.2 mm	2.11" 53.5 mm	1.38" 34.9 mm	1.38" 34.9 mm	1-1/16-12UN-2A	3/4-14 NPTF

Male SAE O-Ring Straight Thread - Female Pipe

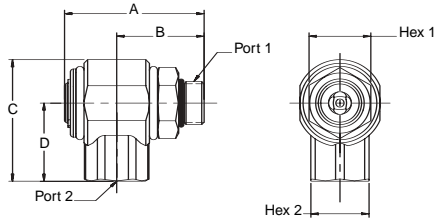

Part number	A	B	C	D	HEX 1	HEX 2	PORT 1	PORT 2
S2502-6-6	2.13" 54.1 mm	1.33" 33.8 mm	1.78" 45.1 mm	1.09" 27.6 mm	.88" 22.2 mm	.88" 22.2 mm	9/16-18UNF-2A	3/8-18 NPTF
S2502-8-8	2.40" 61.0 mm	1.50" 38.2 mm	2.10" 53.3 mm	1.35" 34.3 mm	1.06" 27.0 mm	1.00" 25.4 mm	3/4-16UNF-2A	1/2-14 NPTF
S2502-12-12	3.40" 86.4 mm	2.17" 55.2 mm	2.39" 60.7 mm	1.50" 38.0 mm	1.38" 34.9 mm	1.38" 34.9 mm	1-1/16-12UN-2A	3/4-14 NPTF

Male SAE O-Ring Straight Thread - Male 37° Flare

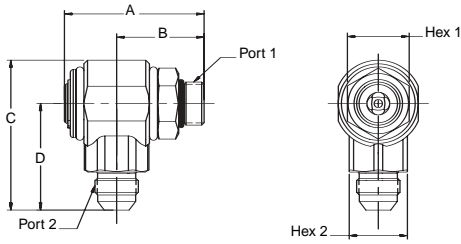

Part number	A	B	C	D	HEX 1	HEX 2	PORT 1	PORT 2
S2503-6-6	2.13" 54.1 mm	1.33" 33.8 mm	2.19" 55.5 mm	1.50" 38.0 mm	.88" 22.2 mm	.88" 22.2 mm	9/16-18UNF-2A	9/16-18UNF-2A
S2503-8-8	2.40" 61.0 mm	1.50" 38.2 mm	2.59" 65.8 mm	1.84" 46.7 mm	1.06" 27.0 mm	1.00" 25.4 mm	3/4-16UNF-2A	3/4-16UNF-2A
S2503-10-10	2.54" 64.5 mm	1.64" 41.7 mm	2.59" 65.8 mm	1.84" 46.7 mm	1.06" 27.0 mm	1.00" 25.4 mm	7/8-14UNF-2A	7/8-14UNF-2A
S2503-12-12	3.40" 86.4 mm	2.17" 55.2 mm	3.07" 77.9 mm	2.17" 55.2 mm	1.38" 34.9 mm	1.38" 34.9 mm	1-1/16-12UN-2A	1-1/16-12UN-2A
S2503-16-16	3.75" 95.3 mm	2.33" 59.2 mm	3.01" 76.5 mm	2.11" 53.6 mm	1.63" 41.4 mm	1.69" 42.9 mm	1-5/16-12UN-2A	1-5/16-12UN-2A

Male SAE O-Ring Straight Thread - Female NPSM Pipe Swivel

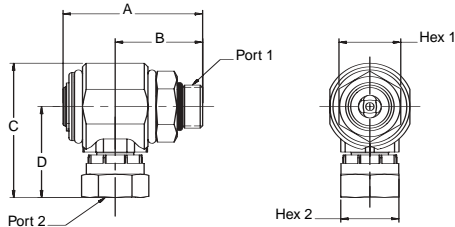

Part number	A	B	C	D	HEX 1	HEX 2	PORT 1	PORT 2
S2507-6-6	2.13" 54.1 mm	1.33" 33.8 mm	2.07" 52.5 mm	1.38" 35.1 mm	.88" 22.2 mm	.88" 22.2 mm	9/16-18UNF-2A	3/8-18 NPSM
S2507-8-8	2.40" 61.0 mm	1.50" 38.2 mm	2.32" 59.0 mm	1.57" 39.9 mm	1.06" 27.0 mm	1.00" 25.4 mm	3/4-16UNF-2A	1/2-14 NPSM
S2507-12-12	3.75" 86.4 mm	2.17" 55.2 mm	2.74" 69.5 mm	1.85" 46.9 mm	1.38" 34.9 mm	1.25" 31.8 mm	1-1/16-12UN-2A	3/4-14 NPSM
S2507-16-16	3.75" 95.3 mm	2.33" 59.2 mm	3.14" 79.8 mm	2.23" 56.6 mm	1.63" 41.4 mm	1.69" 42.9 mm	1-5/16-12UN-2A	1-1 1/2 NPSM

Male SAE O-Ring Straight Thread - Female SAE Straight Thread

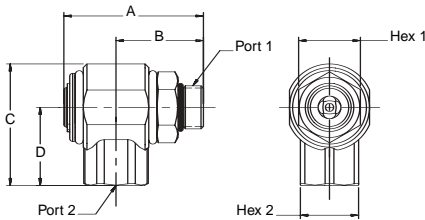

Part number	A	B	C	D	HEX 1	HEX 2	PORT 1	PORT 2
S2510-6-6	2.13" 54.1 mm	1.33" 33.8 mm	1.78" 45.1 mm	1.09" 27.6 mm	.88" 22.2 mm	.88" 22.2 mm	9/16-18UNF-2A	9/16-18UNF-2B
S2510-8-8	2.40" 61.0 mm	1.50" 38.2 mm	2.10" 53.3 mm	1.35" 34.3 mm	1.06" 27.0 mm	1.00" 25.4 mm	3/4-16UNF-2A	3/4-16UNF-2B
S2510-12-12	3.40" 86.4 mm	2.17" 55.2 mm	2.54" 64.5 mm	1.65" 41.9 mm	1.38" 34.9 mm	1.38" 34.9 mm	1-1/16-12UN-2A	1-1/16-12UN-2B

Swivels

Repair Kits/Seal Options

Repair Kits come complete with primary O-Rings, PTFE back-up rings, external and internal dust seals, retaining ring and instruction sheet.

Nitrile Seals		EP Seals		Fluorocarbon Seals	
Size	Kit Number	Size	Kit Number	Size	Kit Number
-4/-6	RK-4/6N	-4/-6	RK-4/6E	-4/-6	RK-4/6V
-8/-10	RK-8N	-8/-10	RK-8E	-8/-10	RK-8V
-12	RK-12N	-12	RK-12E	-12	RK-12V
-16	RK-16N	-16	RK-16E	-16	RK-16V

Check Valves

Multiple Hydraulic System Applications

Parker Check Valves are unidirectional flow control devices used primarily in hydraulic systems to eliminate potential damage caused by fluid back pressure. Offered in many configurations, Parker can satisfy most hydraulic system

applications. Parker's in-line style of Check Valves are available in a variety of sizes, pressure ratings, flow capacities and crack pressures.

Check Valves



IntroductionE-2

Selection Guide.....E-4

**Features & General
Technical Information**E-4

DT SeriesE-5 – E-7

 Ordering InformationE-8

CV Series.....E-9 – E-11

 Ordering InformationE-11

Check Valves

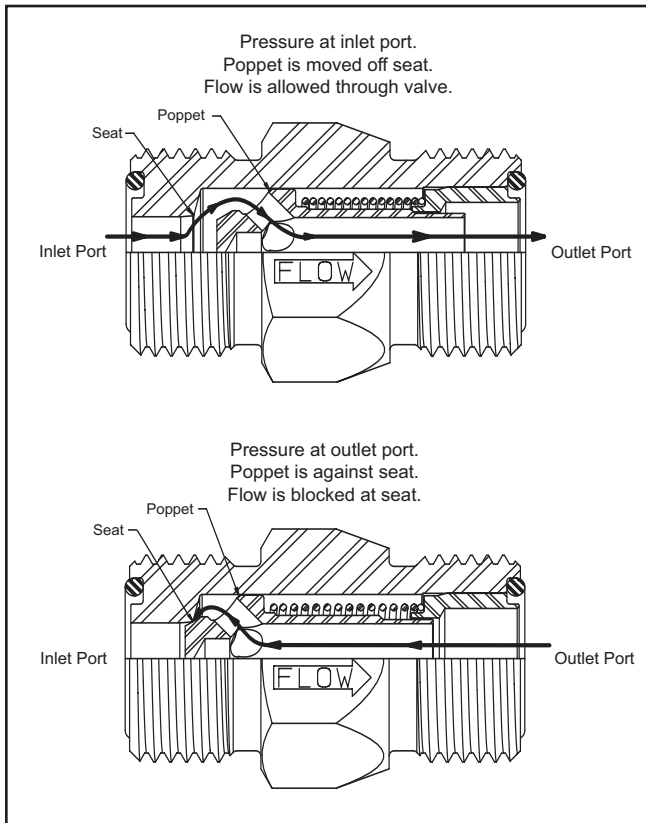

Selection Guide

	Body Size	Material	Rated Pressure	Crack Pressure
CV Series	1/4 - 1"	Steel	3000 PSI	5-130 PSI
DT Series	1/4 - 1 1/4"	Steel	5000 PSI	5-200 PSI

Features

Parker's Check Valves employ several unique features that insure years of trouble-free operation. Specific features for each series of check valves are listed within this section.

Crack Pressure

Crack pressure refers to the amount of fluid pressure in the free flow direction required to move the poppet off the seat. The normal crack pressure setting is 5 PSI; however, other crack pressures are available to allow the check valve to perform special circuit functions, or operate under unique conditions.

Check valves are not field repairable or adjustable. Crack pressure settings are made at the factory only.

Applications

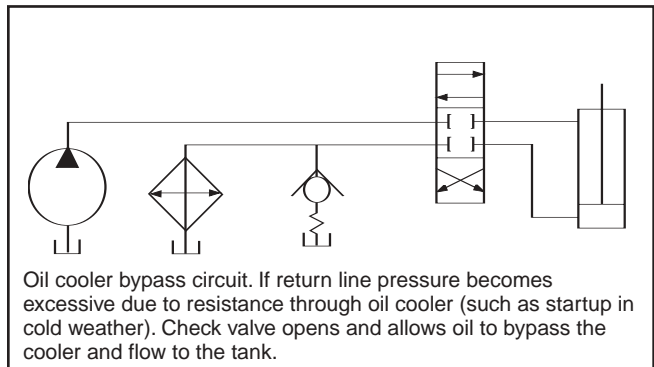
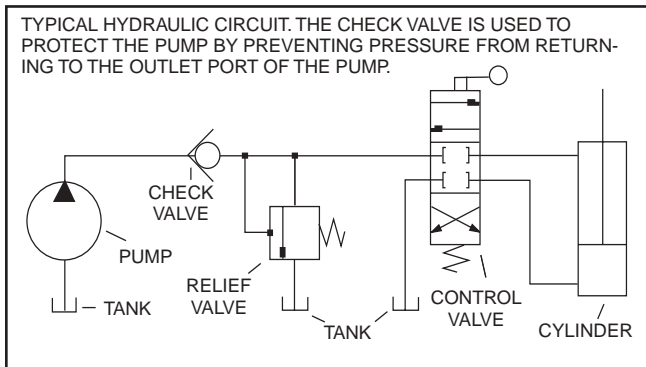

The graphic symbol for a check-valve is:

E Check Valves

Check Valves

Parker DT Series Check Valves Offer the Features of a Compact Body Size, and 5000 PSI Maximum Operating Pressure.

The DT Series check valves utilize the dependable, internal design features found in Parker check valves, but with the added benefit and convenience of compact design. Sizes are available from 1/4" to 1-1/4" with six different Fitting Styles.

The DT Series expands Parker's high quality product line of versatile and efficient check valves.

Features:

1. Compact Design. Easy to plumb into tight circuits.
2. All steel construction. No internal gaskets or seals to wear out.
3. One-piece body eliminates threads and seals that may be potential leakage points.
4. Smooth flow stream. Poppet spring is isolated from flow stream.
5. Heat treated poppet to resist damage from shocks and surges.
6. Variety of end fittings.
7. Optional crack pressures available from 1 to 200 PSI.
8. Zinc plated exterior finish.
9. Nitrile O-Ring included on MO and MS fittings.
10. Captive O-Ring Groove is standard on MS end fittings.

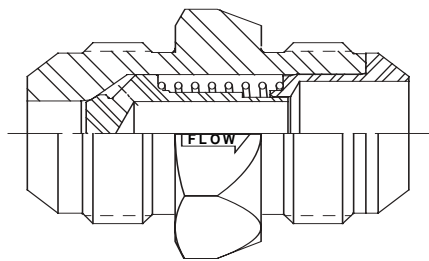

DT-MFMF

Male Flare 37° JIC Inlet to Male Flare 37° JIC Outlet

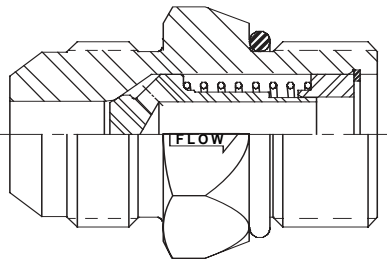

DT-MFMO

Male Flare 37° JIC Inlet to Male O-Ring Boss Outlet

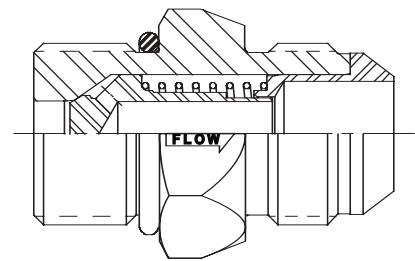

DT-MOMF

Male O-Ring Boss Inlet to Male Flare 37° JIC Outlet

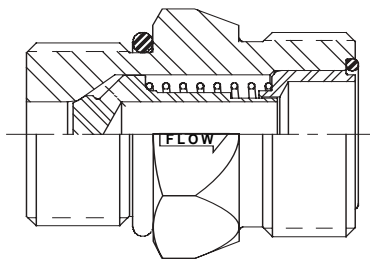

DT-MOMS

Male O-Ring Boss Inlet to Male Seal-Lok® Outlet

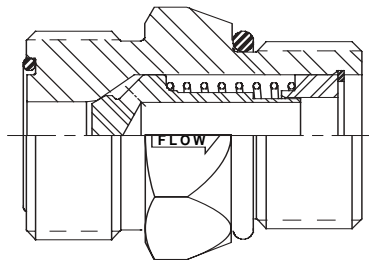

DT-MSMO

Male Seal-Lok® Inlet to Male O-Ring Boss Outlet

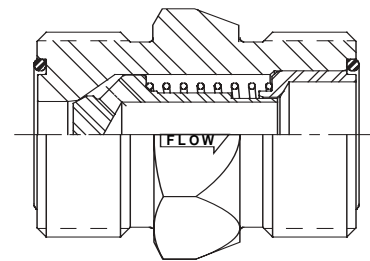

DT-MSMS

Male Seal-Lok® Inlet to Male Seal-Lok® Outlet

Check Valves

Specifications

The DT Series check valves have a Maximum Operating Pressure of 5000 PSI. Standard Crack Pressures are 1, 5, and 65 PSI. Other Crack Pressures up to 200 PSI in 5 PSI increments are available upon request.

DT-MFMF Male Flare 37° JIC Inlet to Male Flare 37° JIC Outlet

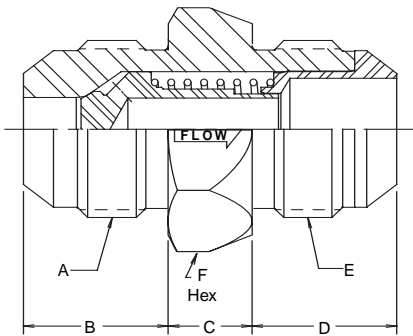

Valve Size (inch)	Part Number	Inlet Port Thread	Dimensions (in)				Outlet Port Thread	Hex Size (inch)	** Std Crack Pressures (PSI)
			A	B	C	D			
3/8	DT-370-MFMF-**	9/16-18 UNF	.56	.44	.56		9/16-18 UNF	.75	1, 5, 65
1/2	DT-500-MFMF-**	3/4-16 UNF	.66	.50	.66		3/4-16 UNF	.88	5, 65
5/8	DT-620-MFMF-**	7/8-14 UNF	.76	.50	.76		7/8-14 UNF	1.06	5
3/4	DT-750-MFMF-**	1-1/16 - 12 UN	.86	.50	.86		1-1/16 - 12 UN	1.25	1, 5, 65
1	DT-1000-MFMF-**	1-5/16 - 12 UN	.91	.62	.91		1-5/16 - 12 UN	1.50	5, 65
1-1/4	DT-1250-MFMF-**	1-5/8 - 12 UN	.96	1.06	.96		1-5/8 - 12 UN	1.88	1, 5

DT-MFMO Male Flare 37° JIC Inlet to Male O-Ring Boss Outlet

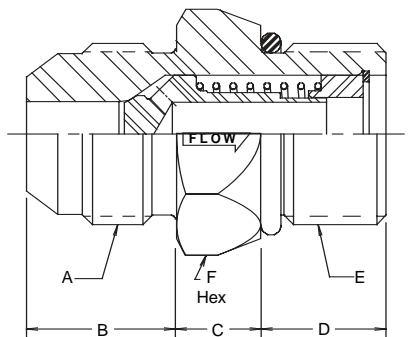

Valve Size (inch)	Part Number	Inlet Port Thread	Dimensions (in)				Outlet Port Thread	Hex Size (inch)	** Std Crack Pressures (PSI)
			A	B	C	D			
1/4	DT-250-MFMO-**	7/16-20 UNF	.55	.44	.43		7/16-20 UNF	.62	5
3/8	DT-370-MFMO-**	9/16-18 UNF	.56	.44	.47		9/16-18 UNF	.75	1, 5, 65
1/2	DT-500-MFMO-**	3/4-16 UNF	.66	.50	.55		3/4-16 UNF	.88	5, 65
5/8	DT-620-MFMO-**	7/8-14 UNF	.76	.50	.63		7/8-14 UNF	1.06	5
3/4	DT-750-MFMO-**	1-1/16 - 12 UN	.86	.50	.73		1-1/16 - 12 UN	1.25	1, 5, 65
1	DT-1000-MFMO-**	1-5/16 - 12 UN	.91	.62	.73		1-5/16 - 12 UN	1.50	5, 65
1-1/4	DT-1250-MFMO-**	1-5/8 - 12 UN	.96	1.06	.73		1-5/8 - 12 UN	1.88	1, 5

DT-MOMF Male O-Ring Boss Inlet to Male Flare 37° JIC Outlet

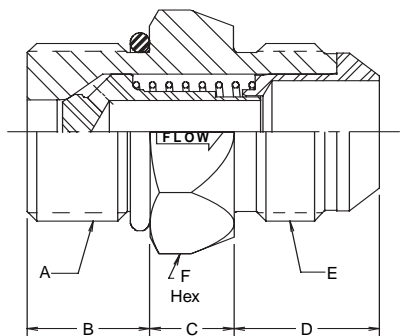

Valve Size (inch)	Part Number	Inlet Port Thread	Dimensions (in)				Outlet Port Thread	Hex Size (inch)	** Std Crack Pressures (PSI)
			A	B	C	D			
1/4	DT-250-MOMF-**	7/16-20 UNF	.43	.44	.55		7/16-20 UNF	.62	5
3/8	DT-370-MOMF-**	9/16-18 UNF	.47	.44	.56		9/16-18 UNF	.75	1, 5, 65
1/2	DT-500-MOMF-**	3/4-16 UNF	.55	.50	.66		3/4-16 UNF	.88	5, 65
5/8	DT-620-MOMF-**	7/8-14 UNF	.63	.50	.76		7/8-14 UNF	1.06	5
3/4	DT-750-MOMF-**	1-1/16 - 12 UN	.73	.50	.86		1-1/16 - 12 UN	1.25	1, 5, 65
1	DT-1000-MOMF-**	1-5/16 - 12 UN	.73	.62	.91		1-5/16 - 12 UN	1.50	5, 65
1-1/4	DT-1250-MOMF-**	1-5/8 - 12 UN	.73	1.06	.96		1-5/8 - 12 UN	1.88	1, 5

E Check Valves

DT Series

Check Valves

DT-MOMS Male O-Ring Boss Inlet to Male Seal-Lok® Outlet

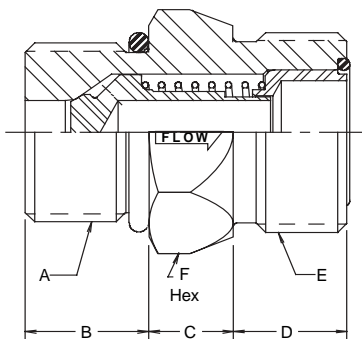

Valve Size (inch)	Part Number	Inlet Port Thread	Dimensions (in)				Outlet Port Thread	Hex Size (inch)	** Std Crack Pressures (PSI)
			A	B	C	D			
1/4	DT-250-MOMS-**	7/16-20 UNF	.43	.45	.39		9/16-18 UNF	.62	5
3/8	DT-370-MOMS-**	9/16-18 UNF	.47	.44	.44		11/16-16 UN	.75	1, 5, 65
1/2	DT-500-MOMS-**	3/4-16 UNF	.55	.50	.51		13/16-16 UN	.88	5, 65
5/8	DT-620-MOMS-**	7/8-14 UNF	.63	.50	.62		1-14 UNS	1.06	5
3/4	DT-750-MOMS-**	1-1/16 - 12 UN	.73	.50	.68		1-3/16 - 12 UN	1.25	1, 5, 65
1	DT-1000-MOMS-**	1-5/16 - 12 UN	.73	.62	.70		1-7/16 - 12 UN	1.50	5, 65
1-1/4	DT-1250-MOMS-**	1-5/8 - 12 UN	.73	1.06	.70		1-11/16 - 12 UN	1.88	1, 5

DT-MSMO Male Seal-Lok® Inlet to Male O-Ring Boss Outlet

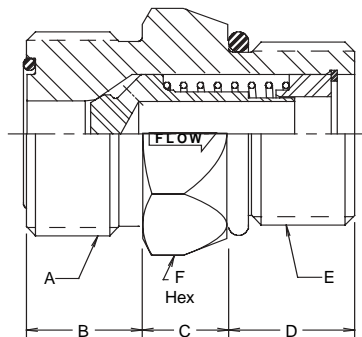

Valve Size (inch)	Part Number	Inlet Port Thread	Dimensions (in)				Outlet Port Thread	Hex Size (inch)	** Std Crack Pressures (PSI)
			A	B	C	D			
3/8	DT-370-MSMO-**	11/16-16 UN	.44	.44	.47		9/16-18 UNF	.75	1, 5, 65
1/2	DT-500-MSMO-**	13/16-16 UN	.51	.50	.55		3/4-16 UNF	.88	5, 65
5/8	DT-620-MSMO-**	1-14 UNS	.62	.49	.63		7/8-14 UNF	1.06	5
3/4	DT-750-MSMO-**	1-3/16 - 12 UN	.68	.50	.73		1-1/16 - 12 UN	1.25	1, 5, 65
1	DT-1000-MSMO-**	1-7/16 - 12 UN	.70	.62	.73		1-5/16 - 12 UN	1.50	5, 65
1-1/4	DT-1250-MSMO-**	1-11/16 - 12 UN	.70	1.06	.73		1-5/8 - 12 UN	1.88	1, 5

DT-MSMS Male Seal-Lok® Inlet to Male Seal-Lok® Outlet

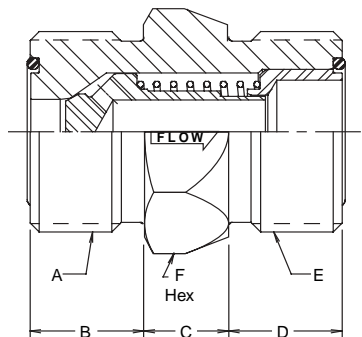

Valve Size (inch)	Part Number	Inlet Port Thread	Dimensions (in)				Outlet Port Thread	Hex Size (inch)	** Std Crack Pressures (PSI)
			A	B	C	D			
3/8	DT-370-MSMS-**	11/16-16 UN	.44	.44	.44		11/16-16 UN	.75	1, 5, 65
1/2	DT-500-MSMS-**	13/16-16 UN	.51	.50	.51		13/16-16 UN	.88	5, 65
5/8	DT-620-MSMS-**	1-14 UNS	.62	.50	.62		1-14 UNS	1.06	5
3/4	DT-750-MSMS-**	1-3/16 - 12 UN	.68	.50	.68		1-3/16 - 12 UN	1.25	1, 5, 65
1	DT-1000-MSMS-**	1-7/16 - 12 UN	.70	.62	.70		1-7/16 - 12 UN	1.50	5, 65
1-1/4	DT-1250-MSMS-**	1-11/16 - 12 UN	.70	1.06	.70		1-11/16 - 12 UN	1.88	1, 5

Check Valves

Flow Data

DT Series (1/4" & 3/8")
Test Fluid: Oil - 200 SUS

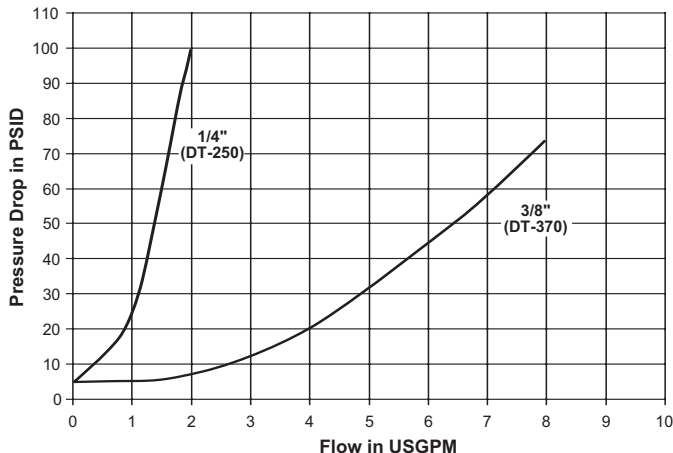

DT Series (1/2", 5/8" & 3/4")
Test Fluid: Oil - 200 SUS

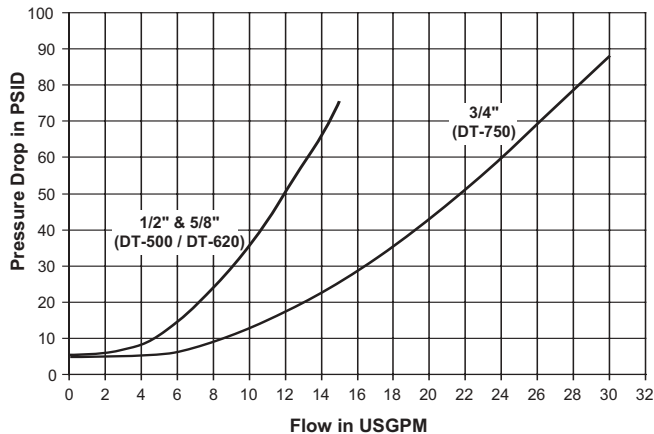

DT Series (1" & 1-1/4")
Test Fluid: Oil - 200 SUS

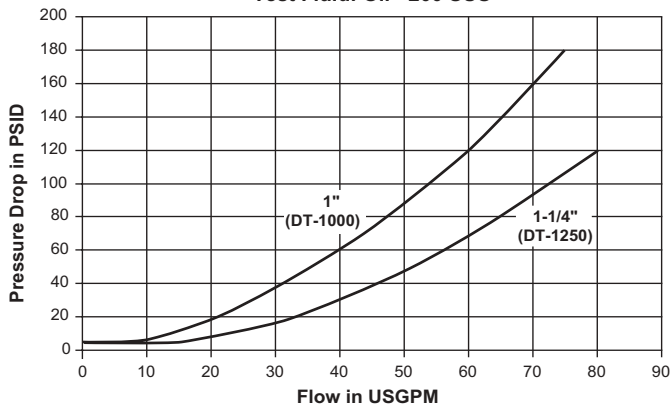

Ordering Information

DT - * * * - * * * * - * *

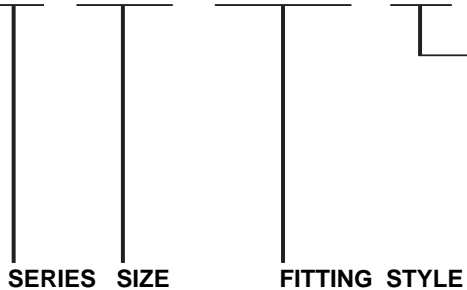

CRACK PRESSURE

- 1 - 1 PSI
- 5 - 5 PSI
- 65 - 65 PSI
- Other Crack Pressures up to 200 PSI in 5 PSI increments are available. Contact the Division for price and delivery on non-standard crack pressures

SERIES	SIZE	FITTING STYLE
250	1/4"	MFMF - Male Flare Inlet to Male Flare Outlet
370	3/8"	MFMO - Male Flare Inlet to Male O-Ring Boss Outlet
500	1/2"	MOMF - Male O-Ring Boss Inlet to Male Flare Outlet
620	5/8"	MOMS - Male O-Ring Boss Inlet to Male Face Seal Outlet
750	3/4"	MSMO - Male Face Seal Inlet to Male O-Ring Boss Outlet
1000	1"	MSMS - Male Face Seal Inlet to Male Face Seal Outlet
1250	1-1/4"	



E Check Valves



CV Series Check Valves Offer Port Thread Options for Special Plumbing Requirements

Parker's CV Series check valves are a rugged built and versatile product designed to protect hydraulic systems from fluid back pressure. The CV Series compliments the DT Series by adding the feature of modular design. This two piece body design offers more end configurations than a one piece body. The larger body also results in less pressure drop and increased performance. The CV Series are in-line unidirectional valves, available in sizes 1/4" to 1", with a pressure rating of up to 3000 PSI, flow capacities to 100 GPM, and a variety of port options. Standard spring crack pressures are 5 and 65 PSI. Other crack pressures available upon request.

Features:

1. Nitrile O-ring is standard in the body assembly. Note port O-rings are included on the MO and MS port options.
2. Available with variety of thread design options.
3. All-steel construction
4. Valve seats resist damage from shocks, surges and contamination.
5. Poppet has an oil retention groove that lubricates the bore and eliminates galling.
6. Poppet spring is isolated from the liquid flow stream, minimizing turbulence.
7. Poppet is heat treated to help prevent damage from shocks, surges and galling.
8. Close tolerance fit between poppet and poppet retainer creates a cushion that protects valve from surge shock damage.
9. Optional crack pressures available upon request.

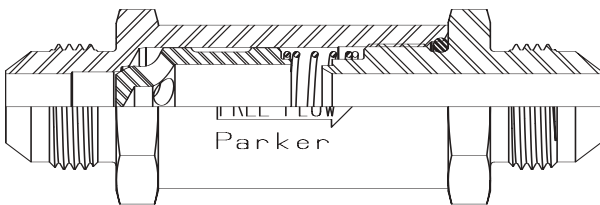
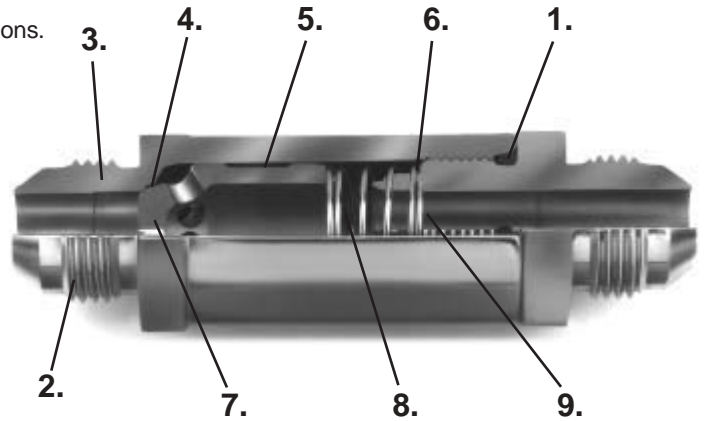

CV-MFMF

Male Flare 37° JIC Inlet to Male Flare 37° JIC Outlet

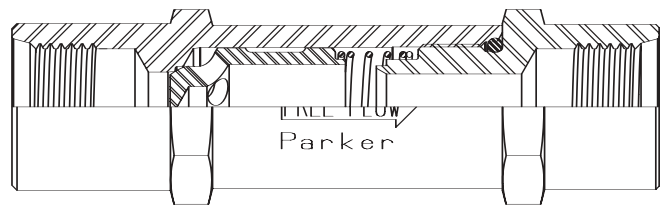

CV-FOFO

Female O-ring Boss Inlet to Female O-ring Boss Outlet

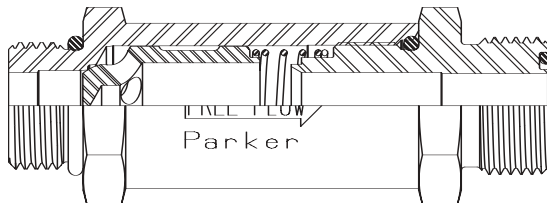

CV-MOMS

Male O-Ring Boss Inlet to Male Seal-Lok® Outlet

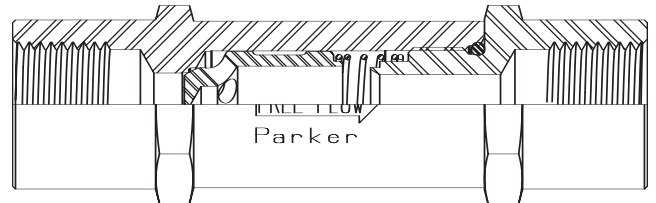

CV-FPPF

Female Pipe Thread Inlet to Female Pipe Thread Outlet

Check Valves

Specifications

CV-MFMF Male Flare 37° JIC Inlet to Male Flare 37° JIC Outlet

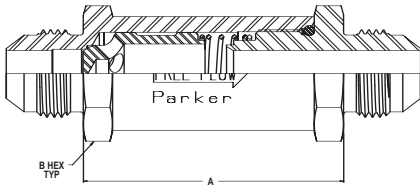

Valve Size (inch)	Part Number	Inlet Port Thread	Dimensions (inch)		Outlet Port Thread	** Std Crack Pressures (PSI)	Max Operating Pressure (PSI)
			A	B Hex			
1/4	CV-250-MFMF-**	7/16-20 UNF	1.53	.68	7/16-20 UNF	5, 65	3000
3/8	CV-370-MFMF-**	9/16-18 UNF	1.75	.81	9/16-18 UNF	5, 65	3000
1/2	CV-500-MFMF-**	3/4-16 UNF	2.22	1.00	3/4-16 UNF	5, 65	3000
5/8	CV-620-MFMF-**	7/8-14 UNF	2.41	1.12	7/8-14 UNF	5, 65	3000
3/4	CV-750-MFMF-**	1-1/16-12 UN	2.75	1.38	1-1/16-12 UN	5, 65	3000
1	CV-1000-MFMF-**	1-5/16-12 UN	3.31	1.62	1-5/16-12 UN	5, 65	3000

CV-MOMS Male O-Ring Boss Inlet to Male Seal-Lok® Outlet

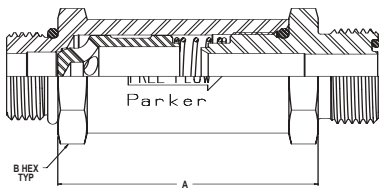

Valve Size (inch)	Part Number	Inlet Port Thread	Dimensions (inch)		Outlet Port Thread	** Std Crack Pressures (PSI)	Max Operating Pressure (PSI)
			A	B Hex			
1/4	CV-250-MOMS-**	7/16-20 UNF	1.53	.68	9/16-18 UNF	5, 65	3000
3/8	CV-370-MOMS-**	9/16-18 UNF	1.75	.81	11/16-16 UN	5, 65	3000
1/2	CV-500-MOMS-**	3/4-16 UNF	2.22	1.00	13/16-16 UN	5, 65	3000
5/8	CV-620-MOMS-**	7/8-14 UNF	2.41	1.12	1-14 UNS	5, 65	3000
3/4	CV-750-MOMS-**	1-1/16-12 UN	2.75	1.38	1-3/16-12 UN	5, 65	3000
1	CV-1000-MOMS-**	1-5/16-12 UN	3.31	1.62	1-7/16-12 UN	5, 65	3000

CV-FOFO Female O-ring Boss Inlet to Female O-ring Boss Outlet

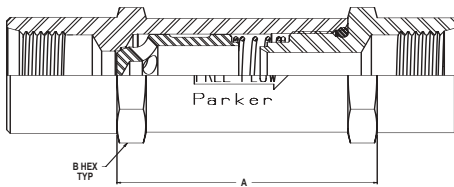

Valve Size (inch)	Part Number	Inlet Port Thread	Dimensions (inch)		Outlet Port Thread	** Std Crack Pressures (PSI)	Max Operating Pressure (PSI)
			A	B Hex			
1/4	CV-250-FOFO-**	7/16-20 UNF	1.53	.68	7/16-20 UNF	5, 65	3000
3/8	CV-370-FOFO-**	9/16-18 UNF	1.75	.81	9/16-18 UNF	5, 65	3000
1/2	CV-500-FOFO-**	3/4-16 UNF	2.22	1.00	3/4-16 UNF	5, 65	3000
5/8	CV-620-FOFO-**	7/8-14 UNF	2.41	1.12	7/8-14 UNF	5, 65	3000
3/4	CV-750-FOFO-**	1-1/16-12 UN	2.75	1.38	1-1/16-12 UN	5, 65	3000
1	CV-1000-FOFO-**	1-5/16-12 UN	3.31	1.62	1-5/16-12 UN	5, 65	3000

Check Valves

CV-FPPF Female Pipe Thread Inlet to Female Pipe Thread Outlet

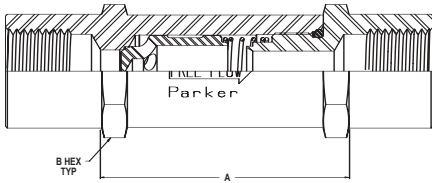

Valve Size (inch)	Part Number	Inlet Port Thread	Dimensions (inch)		Outlet Port Thread	** Std Crack Pressures (PSI)	Max Operating Pressure (PSI)
			A	B Hex			
1/4	CV-250-FPPF-**	1/4-18 NPSF	1.53	.75	1/4-18 NPSF	5, 65	3000
3/8	CV-370-FPPF-**	3/8-18 NPSF	1.75	.81	3/8-18 NPSF	5, 65	3000
1/2	CV-500-FPPF-**	1/2-14 NPSF	2.22	1.12	1/2-14 NPSF	5, 65	3000
3/4	CV-750-FPPF-**	3/4-14 NPSF	2.75	1.38	3/4-14 NPSF	5, 65	3000
1	CV-1000-FPPF-**	1 - 11-1/2 NPSF	3.31	1.62	1 - 11-1/2 NPSF	5, 65	3000

Flow Data

CV Series (1/4" & 3/8")
Test Fluid: Oil - 200 SUS

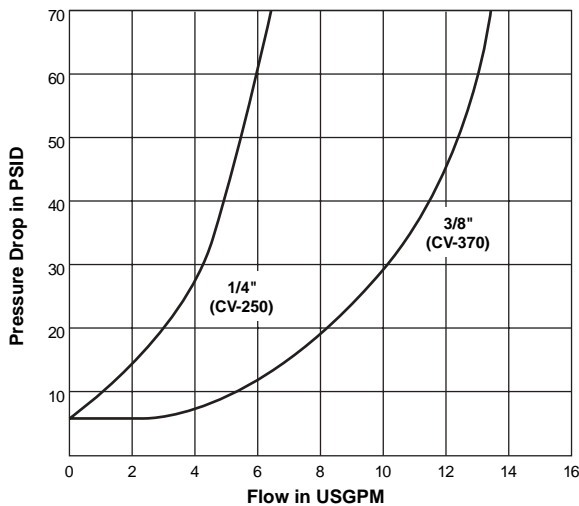

CV Series (1/2", 5/8", 3/4" & 1")
Test Fluid: Oil - 200 SUS

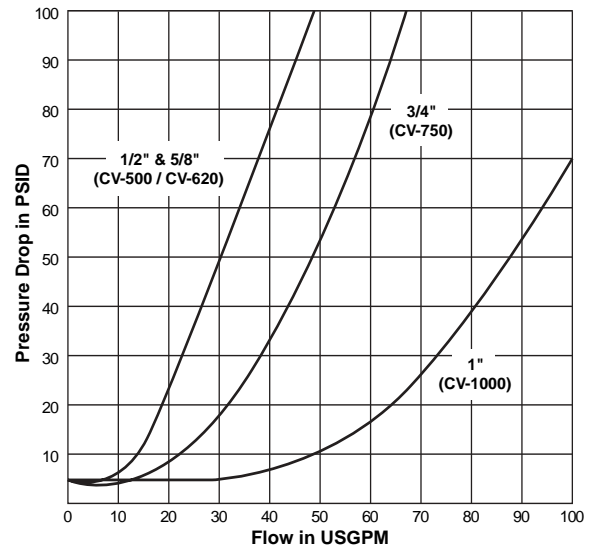

Ordering Information

CV - * * * - * * * * - * *

CRACK PRESSURE
5 - 5 PSI
65 - 65 PSI
Other Crack Pressures up to 200 PSI in 5 PSI increments are available. Contact the Division for price and delivery on non-standard crack pressures

SERIES	SIZE	FITTING STYLE
250	1/4"	FOFO - Female O-Ring Boss Inlet to Female O-Ring Boss Outlet
370	3/8"	MFMF - Male Flare Inlet to Male Flare Outlet
500	1/2"	MOMS - Male O-Ring Boss Inlet to Male Seal-Lok® Outlet
620	5/8"	FPPF - Female Pipe Inlet to Female Pipe Outlet
750	3/4"	
1000	1"	



Quick Coupling Diagnostic Products



Increasing productivity and profitability are the key elements for a company to successfully compete in the world market today.

Reduced machine downtime during initial set-up, trouble shooting and maintenance procedures means increased productivity for you. That's why Parker provides the most complete line of hydraulic and pneumatic diagnostic equipment available today.

With Parker diagnostic equipment you can take critical measurements from your system with just a push of a button. Parker diagnostic instruments are designed to identify hard-to detect variations and peaks in pressures, temperatures and flow.

Parker diagnostic quick couplings and nipples allow quick

and easy access into hydraulic or pneumatic systems at remote test points without the use of tools.

Diagnostic nipples can be permanently installed in threaded test ports in hydraulic components such as valves, cylinders, accumulators, filters or pumps.

Diagnostic tube ends, used in conjunction with a 37° flare, bite type, or O-ring face seal tube fitting, will allow you to take pressure readings in your systems tubing and hose lines where threaded test ports may not currently be available.

From diagnostic nipples to digital readout and printing equipment, Parker can provide you, from over 600 stocking distributors, the tools necessary to increase your productivity through reduced machine downtime.

Diagnostic Products



Introduction	F-2	Test Port Couplings	
Table of Contents.....	F-3	PD Series.....	F-18 - F-20
Product Selection Guide.....	F-4	Dust Cap.....	F-18
ServiceJunior™	F-5	Couplers	F-19
SensoControl® Serviceman™		Nipples.....	F-19 - F-20
General.....	F-6	Tube End Nipples	F-20
Schematic.....	F-7	PDP Series	F-21 - F-23
Technical Data	F-8	Dust Cap.....	F-21
Tachometer, Cable & Temp Sensor	F-8 - F-9	Couplers	F-21
Test Meter Kits	F-10	Nipples.....	F-22
SensoControl® ServiceMaster™		EMA3 Series.....	F-23
General.....	F-11	Nipples.....	F-23
Schematic.....	F-12	Gauge Adapter & Union	F-24
Technical Data	F-13	Transducer Adapters.....	F-25
SensoControl® Transducer.....	F-14	Flexible Hose	F-25
Components and Accessories.....	F-15	PDFS Series - Fluid Sampling.....	F-26
Test Meter Kits	F-16	Couplers	F-26
PDF Series Flow Sensors	F-17	Nipples.....	F-26
		Ordering Information.....	F-27

Diagnostic Products

Meter Selection Guide



Function	ServiceJunior	Serviceman Level 1	Serviceman Level 2	ServiceMaster 350	ServiceMaster 450
Pressure Sensing	•	•	•	•	•
Flow Sensing		•1	•1	•1	•1
Temperature Sensing		•1	•1	•2	•2
Rotational Speed Sensing		•1	•1	•	•
Auxiliary Sensing				•	•
Pressure Differential		•	•	•	•
Automatic Sensor Recognition	•	•	•	•	•
Auto Power Off	•	•	•	•	•
Battery Monitoring	•	•	•	•	•
Battery Type	AA (2 req'd)	Rechargeable Ni-MH	Rechargeable Ni-MH	Rechargeable Ni-Cad	Rechargeable Ni-Cad
PC Compatible (Windows)			•1	•1	•1
Minimum/Maximum Memory	•	•	•	•	•
Self Contained Memory				•	•
On-Line Data Transfer			•	•	•
Text Display (Lines)	2	1	1	8	8
Inputs	1	2	2	3	6
Data Points (Maximum in Memory)				125,000	250,000
Graphic LCD Display	•			•	•
Hydraulic Power Calculations				•	•
Volume Calculations				•	•

Notes: (1) Additional accessories are required to perform this function.
 (2) Transducers provide an ambient temperature signal, but additional temperature probes are required for more accurate temperature measurements.

Test Port Coupling Selection Guide

Test Port	Valving	Body Size	Material* Br SS S P	Locking Mechanism	Std. Seal Material	Temp Range**	Rated Pressure
PD Series	Flush Face	1/8"	• • •	Ball	Nitrile	-40° to +250° F	6000 PSI
PDP Series	Ball	1/8"	•	Ball	Nitrile	-40° to +250° F	6000 PSI
EMA3 Series	Poppet	1/8"	• •	Threads	Nitrile	-15° to +250° F	9000 PSI

* See Fluid Compatibility chart and/or consult factory for questions regarding proper material for specific applications.
 CODE: Br = Brass; SS = Stainless Steel; S = Steel; P = Plastic
 **Temperature Range for standard seal material.

Note: See the Specifications Table for PD and PDP Series for more information.

The new Parker ServiceJunior captures momentary pressure spikes that are “invisible” to normal liquid-filled gauges. That means the maximum pressure reading it delivers can be trusted as a much truer reflection of the system’s actual condition; so you can identify potential problems better and diagnose their causes faster. All readings are accurate to within +/-0.5%.

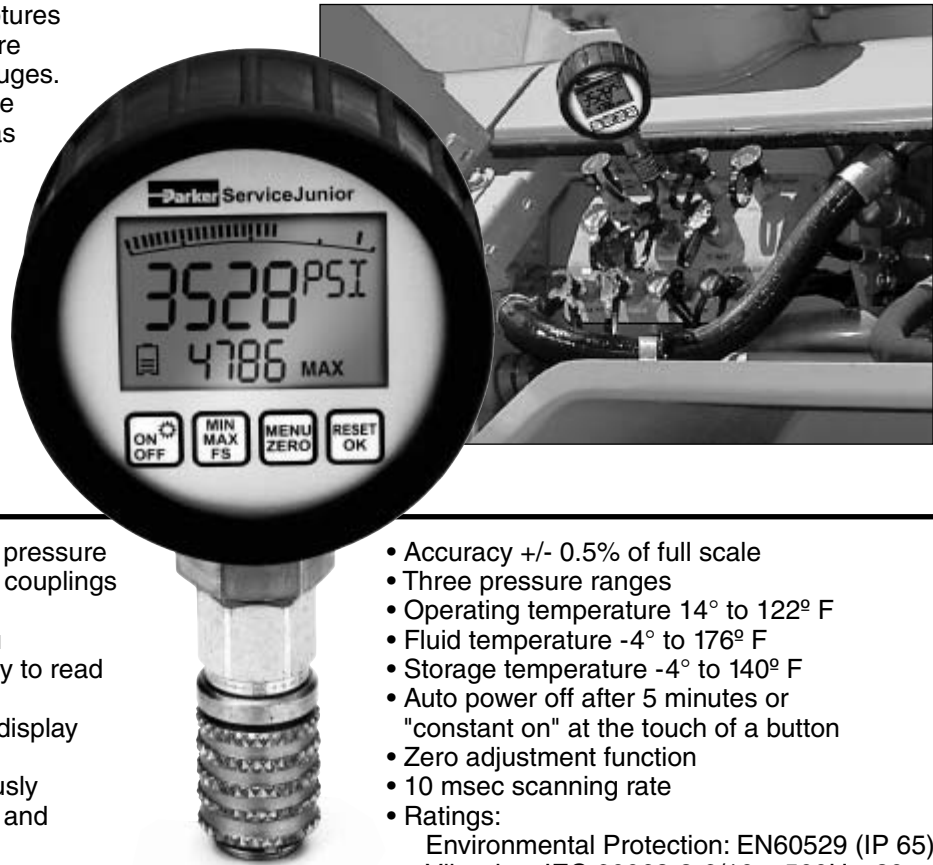

ServiceJunior Features

- Easy to connect and test system pressure using Parker Diagnostic test port couplings
- Robust, dirt resistant housing
- Simple to operate, four key menu
- Four digit backlit display with easy to read large 0.60" characters
- Minimum and maximum graphic display shows pressure peak
- Power status displayed continuously
- Can be used with most hydraulic and pneumatic media
- Measure PSI, bar, mPa, kPa with one gauge

- Accuracy +/- 0.5% of full scale
- Three pressure ranges
- Operating temperature 14° to 122° F
- Fluid temperature -4° to 176° F
- Storage temperature -4° to 140° F
- Auto power off after 5 minutes or "constant on" at the touch of a button
- Zero adjustment function
- 10 msec scanning rate
- Ratings:
 Environmental Protection: EN60529 (IP 65)
 Vibration: IEC 60068-2-6/10 – 500Hz: 20g
 Shock: IEC 60068-2-29/50g 11 msec

Measuring Range	ServiceJunior with PD Coupler	ServiceJunior with EMA3 Coupler	ServiceJunior with 1/4" NPT Port	Overload Pressure	Resolution
-14.5 to 250 PSI (-1 to 16 bar)	SCJR-0250-PD	SCJR-0250-EMA	SCJR-0250-4MP	580 PSI	0.1 PSI
0 to 5800 PSI (0 to 400 bar)	SCJR-5800-PD	SCJR-5800-EMA	SCJR-5800-4MP	11,600 PSI	1 PSI
0 to 8700 PSI (0 to 600 bar)	SCJR-8700-PD ¹	SCJR-8700-EMA ²	SCJR-8700-4MP	17,400 PSI	1 PSI

NOTES: 1. PD Couplers rated to 6,000 PSI max. 2. EMA3 Couplers rated to 9,000 PSI max.

Accessories

Part Number	Description
PD240	PD Series diagnostic coupler
SCA-7/16-EMA-3	7/16 -18UNF-2B female to M16X2.0 EMA3 female swivel
SCJA-1/4	7/16 -18UNF-2B female to 1/4" NPT male adapter
PDH-19	19" PD Hose extension to be used with PD nipple interface
SMA3-400	16" hose assembly for EMA M16X2.0 interface
SCC-110	Storage case for one gauge and diagnostic adapters
SCC-120	Storage case for two gauges and diagnostic adapters

Hand-held diagnostic meter to measure pressure, temperature, flow and rotational speed for hydraulic and pneumatic systems

- Easy operation
- Rugged design
- Compact dimensions
- Large display
- Auto sensor recognition
- MIN/MAX Memory
- Hold function
- Pressure differential
- Low power consumption
- External power supply
- Data output for PC*

*SCM-150-1-02 Only



The Serviceman™ SCM-150 from Parker is a modern portable diagnostic measuring system and an excellent alternative to conventional mechanical pressure gages.

The SCM-150 is a very rugged and durable test meter that can withstand even the most demanding environmental conditions. It comes with a protective rubber cover and integrated stand making it easy to operate as a hand-held unit or as a desktop display.

Operating the SCM-150 is very simple. Everything is controlled by eight easy to read push buttons. The two sensor inputs allow you to read pressure, temperature, flow and RPM. The automatic sensor recognition circuit properly displays the sensor connected to each of the inputs, eliminating complicated adjustments and calibrations on the meter. The unit also features a memory function that allows you to

store both minimum and maximum recorded values. Another very beneficial feature is the “pressure differential” function. This allows you to display the actual pressure drop between two different test points in the hydraulic or pneumatic system.

Both Serviceman meters are powered by a rechargeable Ni-MH (Nickel Metal-Hydride) battery system and can also be connected to a 120 volt external power supply for continuous operation. The low power consumption allows these units to be used for extended periods of time independent of an external power supply.

The Serviceman Level 2 can also be directly interfaced to an Excel spreadsheet via the auxiliary computer adapter and Serviceman software. The Parker Serviceman software is compatible with all Windows 95 and newer operating systems.

These Serviceman kits are the ideal diagnostic tools for maintenance and service personnel in the industrial, mobile and agricultural markets. Increasing productivity and profitability are key elements to a company’s success. These units will help reduce downtime by providing the best preventative maintenance and diagnostic data available.

Parker Hannifin provides the most complete line of hydraulic and pneumatic diagnostic equipment available today. For more information or to receive a full demonstration, contact the Quick Coupling Division or your local distributor.

SensoControl® Serviceman™
Measure and Document Flow, Pressure,
Temperature and Rotation Speed

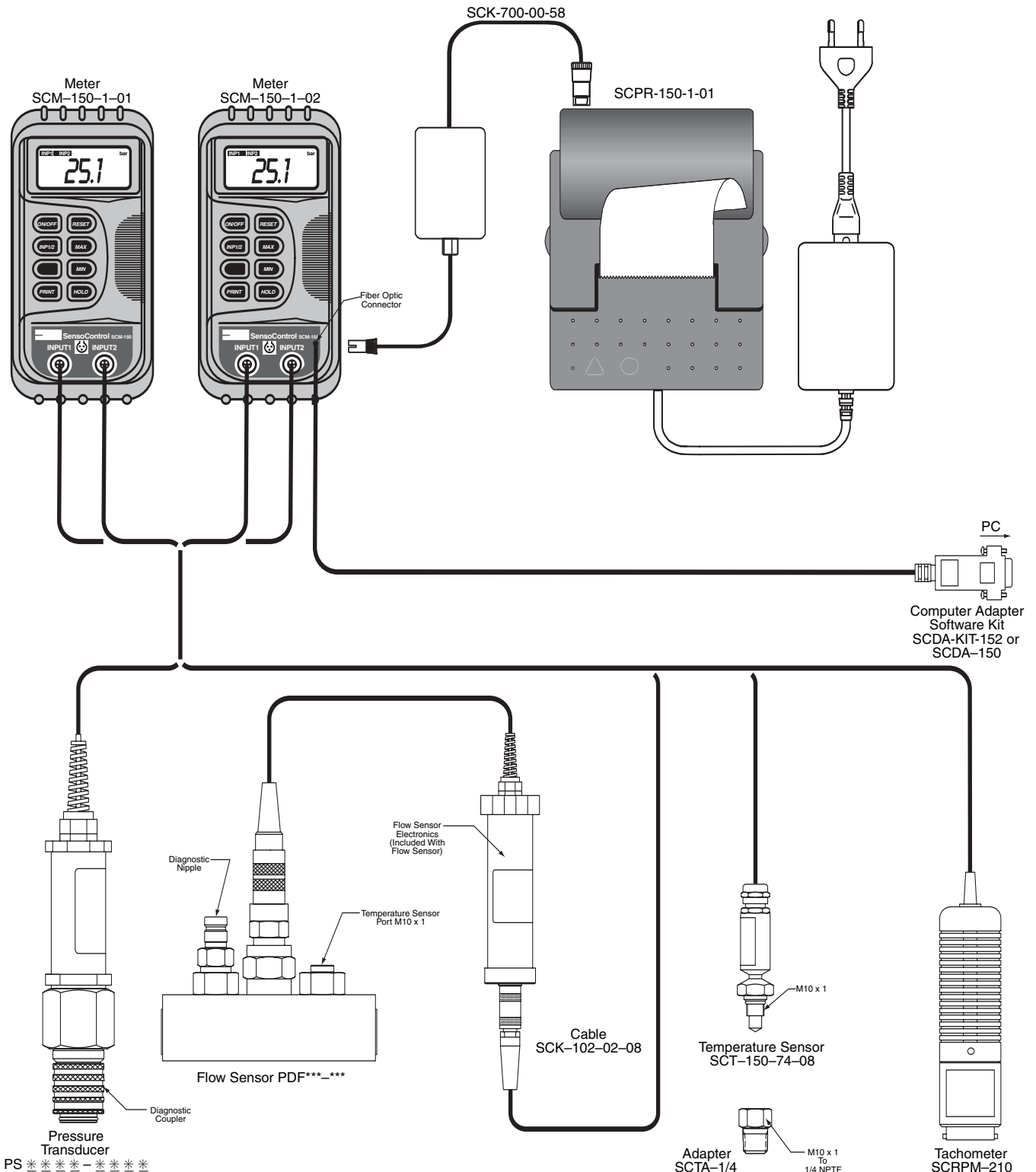

F Diagnostic

Technical Data

Meter

- 4 Digit LCD Text Display
- 13 mm Character Height
- Display of Pressure, Temperature, Flow and Rotational Speed
 - Pressure in PSI and Bar
 - Temperature in °F and °C
 - Flow in GPM and l/min.
 - Rotational Speed in RPM
- Automatic Sensor Recognition
- 2 ms Scanning Rate

Housing

- ABS Plastic Housing
- Protective Rubber Cover
- Carrying Strap
- Integral Stand

Inputs

- Two 4-pin Round plugs
- 0-3 Volts (R=470 kΩ)
- 12 Bit A/D Converter

Ambient Conditions

- Operating Temperatures 32°F to 122°F (0°C to 50°C)
- Storage Temperatures -4°F to 140°F (-20°C to 60°C)

Output (SCM-150-1-02 Level 2 meter only)

- SC Infrared Interface (RS232C) to transfer measured values to a PC. The SCDA-150 software and adapter kit is required for data transfer to a PC.

Power Requirements (Both Meters)

- SCM-150-1-01 (Level 1)
- SCM-150-1-02 (Level 2)
 - 9 Volt Rechargeable Ni-MH Battery
 - Recharge circuit for use with external power supply.
 - Use part number SCSN-450 for operating the meter.

Pressure Transducers

Pressure Ranges

- PS *** TA-015 -14.5 to 220 PSI (-1 to 15 Bar)
- PS *** TA-100 0 to 1450 PSI (0 to 150 Bar)
- PS *** TA-1000 0 to 14,500 PSI (0 to 1000 Bar)

Note: Transducer coupler must be specified when being ordered. Maximum pressure rating is based on diagnostic coupling selected.

Construction

- Piezo-Resistive Circuitry
- Stainless Steel Housing
- Stainless Steel Diaphragm
- Fluorocarbon Seals
- Integrated Cable Assembly

Power Requirement

- 7-12 Volt DC Excitation Voltage
- 5 ma Current Requirement

Output

- 0-3 Volts DC
- 1 ms Response Time
- 5 FS/a Long Term Stability
- ± .03 FS Temperature Error
- ± .08 FS Reproducibility
- .5% Accuracy Full Scale

Functional Description SCM-150

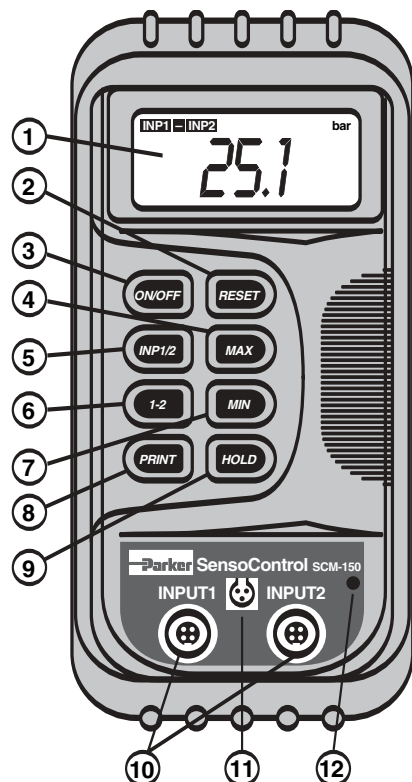

- 1 Measurement Display (4-digit)
- 2 RESET resets minimum and maximum values to zero
- 3 ON/OFF Switch
- 4 MAX displays maximum value since meter was last reset or turned on
- 5 INP1/2 selects whether meter will display measurement from Input 1 or Input 2
- 6 Δ1-2 displays the differential value of Input 1 minus Input 2
- 7 MIN displays minimum value since meter was last reset or turned on
- 8 PRINT* sends displayed measurements to PC or printer
- 9 HOLD freezes displayed measurement
- 10 Analog Inputs (4 pin)
- 11 External Power Supply Socket
- 12 Data Output* infrared interface to transmit measured values to PC

* SCM-150-1-02 only

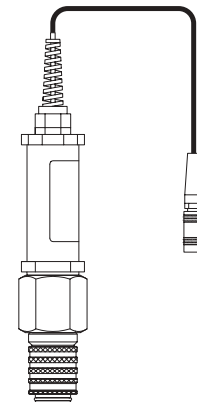

Transducer shown with PD Style Coupler option.

Temperature Probe

- SCT-150-74-08
- -13°F to 257°F (25°C to 125°C)

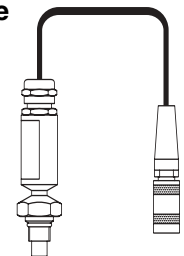

F Diagnostic

Order Code

Order No.	Description
SCM-150-1-01	Serviceman™ Level 1 hand-held meter
SCM-150-1-02	Serviceman™ Level 2 hand-held meter
SCC-150	Storage case for Serviceman™ Level 1 or Level 2
SCSN-450	120 Volt AC power supply/recharger for Serviceman™ and ServiceMaster™ meters
SCK-102-02-08	Connecting cable (4-pin to 5-pin) required to connect flow sensors and PDT transducers to the Serviceman™ meters (2 m length)
SCK-108-03-18	Extension cable used in series with the 4-pin PST transducer assemblies (3 m length)
SCG-022	Replacement paper for thermal printer SCPR-150-1-01
SCDA-150 SCDA-KIT-152	Computer adapter and software to transfer data from Serviceman™ Level 2 to a PC (Includes computer cable) Contact the Division for ordering assistance
SCRPM-210	Tachometer used to measure rotational speed (20 to 10,000 RPM)
SCRPMA-001	Contact adapter for SCRPM-210 tachometer
SCRPMA-002	Focus adapter for SCRPM-210 tachometer
SCT-150-74-08	Temperature sensor used with the PDF flow sensors or with SCTA-1/4 port adapter
SCTA-1/4	Port adapter to convert M10 X 1 to 1/4" NPT for use with the SCT-150-74-08
PDH-19	Diagnostic test hose assembly (.5 m length extension hose assembly used with PD transducers and diagnostic nipples)
PD288	PD style pressure transducer adapter
PDP288	PDP style pressure transducer adapter
SCA-1/2-EMA-3	EMA3 female pressure transducer adapter
SCA-1/2-EMA-3-S	EMA3 male pressure transducer adapter
SCM150-TM	Serviceman™ training manual
SCPR-KIT-150	Serviceman™ printer kit – includes SCK-700-00-58 interface cable, power supply & SCPR-150-1-01 printer

SCRPM Tachometer



SCRPM-210

Part Number	Connector	Compatibility
SCRPM-210	4-pin DIN	Serviceman™

Accessories

Part Number	Description
SCRPMA-001	Contact adapter for belt drive/wheel
SCRPMA-002	Focus adapter for confined areas

The **SCRPM Tachometer** provides precision measurement of rotational speed. This sensor emits a light beam through an LED source. This light source is reflected and picked up as a pulse. It is then converted to an analog signal and displayed on the hand held meter.

Technical Data

Measuring Range20 – 10,000 RPM
 Measuring Distance0.1 – 19.5 inches
 Accuracy.....0.5%
 Excitation Voltage.....7 – 9 VDC
 Output Signal0 – 3 VDC
 Resolution5 RPM

5 pin to 4 pin Cable



5 Pin – 4 Pin
Flow Sensor to
Serviceman™ Cable
SCK-102-02-08

Temperature Sensor



Temperature Sensor
(Serviceman™)
SCT-150-74-08

Test Meter Kits



Kit Contents:	Serviceman Level 1 Meter Kit	Serviceman Level 2 Meter Kit
Case	SCC-150	SCC-150
Serviceman Meter	SCM-150-1-01	SCM-150-1-02
Transducers (Quantity 1 or 2)	(See Below)	(See Below)
Power Supply – Meter	SCSN-450	SCSN-450
Instruction Manual*	SCM150-TM	SCM150-TM
* Included with Serviceman Meter		

Code for Ordering Serviceman Meter Kits:
PD XX - XXX - XX - XX (If second Transducer is ordered as part of Kit)

<p>Transducer Style</p> <p>Port Style</p> <p>Meter Style</p>	<table border="1"> <thead> <tr> <th>CODE</th> <th>DESCRIPTION</th> </tr> </thead> <tbody> <tr> <td>200</td> <td>PD Style</td> </tr> <tr> <td>400</td> <td>PDP Style</td> </tr> <tr> <td>600</td> <td>EMA3 Style (Female)</td> </tr> </tbody> </table>	CODE	DESCRIPTION	200	PD Style	400	PDP Style	600	EMA3 Style (Female)	<table border="1"> <thead> <tr> <th>CODE</th> <th>PRESSURE</th> </tr> </thead> <tbody> <tr> <td>01</td> <td>-14.5 – +220 PSI (Low)</td> </tr> <tr> <td>05</td> <td>0 – 1450 PSI (Medium)</td> </tr> <tr> <td>10</td> <td>0 – 14,500 PSI (High)</td> </tr> </tbody> </table>	CODE	PRESSURE	01	-14.5 – +220 PSI (Low)	05	0 – 1450 PSI (Medium)	10	0 – 14,500 PSI (High)
	CODE	DESCRIPTION																
	200	PD Style																
400	PDP Style																	
600	EMA3 Style (Female)																	
CODE	PRESSURE																	
01	-14.5 – +220 PSI (Low)																	
05	0 – 1450 PSI (Medium)																	
10	0 – 14,500 PSI (High)																	
<table border="1"> <thead> <tr> <th>CODE</th> <th>DESCRIPTION</th> </tr> </thead> <tbody> <tr> <td>S1</td> <td>Serviceman Level 1 Meter</td> </tr> <tr> <td>S2</td> <td>Serviceman Level 2 Meter</td> </tr> </tbody> </table>	CODE	DESCRIPTION	S1	Serviceman Level 1 Meter	S2	Serviceman Level 2 Meter												
CODE	DESCRIPTION																	
S1	Serviceman Level 1 Meter																	
S2	Serviceman Level 2 Meter																	

Code for Ordering Additional Transducers Separately:

PS XXXXX - XXXX

<p>Transducer Style</p> <p>Port Style</p>	<table border="1"> <thead> <tr> <th>CODE</th> <th>DESCRIPTION</th> </tr> </thead> <tbody> <tr> <td>TA</td> <td>PD Style</td> </tr> <tr> <td>PTA</td> <td>PDP Style</td> </tr> <tr> <td>EMA3TA</td> <td>EMA3 Style (Female)</td> </tr> </tbody> </table>	CODE	DESCRIPTION	TA	PD Style	PTA	PDP Style	EMA3TA	EMA3 Style (Female)	<table border="1"> <thead> <tr> <th>CODE</th> <th>PRESSURE</th> </tr> </thead> <tbody> <tr> <td>015</td> <td>-14.5 – +220 PSI (Low)</td> </tr> <tr> <td>100</td> <td>0 – 1,450 PSI (Medium)</td> </tr> <tr> <td>1000</td> <td>0 – 14,500 PSI High</td> </tr> </tbody> </table>	CODE	PRESSURE	015	-14.5 – +220 PSI (Low)	100	0 – 1,450 PSI (Medium)	1000	0 – 14,500 PSI High
	CODE	DESCRIPTION																
TA	PD Style																	
PTA	PDP Style																	
EMA3TA	EMA3 Style (Female)																	
CODE	PRESSURE																	
015	-14.5 – +220 PSI (Low)																	
100	0 – 1,450 PSI (Medium)																	
1000	0 – 14,500 PSI High																	

Code for Ordering Flow Sensors (Generation II) Separately:

PDF XXX - XXXX

<p>Flow Sensor Style</p> <p>Nipple Style</p>	<table border="1"> <thead> <tr> <th>CODE</th> <th>DESCRIPTION</th> </tr> </thead> <tbody> <tr> <td>PD</td> <td>PD Style</td> </tr> <tr> <td>PDP</td> <td>PDP Style</td> </tr> <tr> <td>EMA</td> <td>EMA Style</td> </tr> </tbody> </table>	CODE	DESCRIPTION	PD	PD Style	PDP	PDP Style	EMA	EMA Style	<table border="1"> <thead> <tr> <th>CODE</th> <th>FLOW RATE</th> </tr> </thead> <tbody> <tr> <td>0004</td> <td>.25 – 4 GPM (1.0 – 15 L/Min)</td> </tr> <tr> <td>0216</td> <td>2 – 16 GPM (7.5 – 60 L/Min)</td> </tr> <tr> <td>0480</td> <td>4 – 80 GPM (15 – 300 L/Min)</td> </tr> <tr> <td>7160</td> <td>7 – 160 GPM (25 – 600 L/Min)</td> </tr> </tbody> </table>	CODE	FLOW RATE	0004	.25 – 4 GPM (1.0 – 15 L/Min)	0216	2 – 16 GPM (7.5 – 60 L/Min)	0480	4 – 80 GPM (15 – 300 L/Min)	7160	7 – 160 GPM (25 – 600 L/Min)
	CODE	DESCRIPTION																		
PD	PD Style																			
PDP	PDP Style																			
EMA	EMA Style																			
CODE	FLOW RATE																			
0004	.25 – 4 GPM (1.0 – 15 L/Min)																			
0216	2 – 16 GPM (7.5 – 60 L/Min)																			
0480	4 – 80 GPM (15 – 300 L/Min)																			
7160	7 – 160 GPM (25 – 600 L/Min)																			

NOTES: Cable SCK-102-08 is required for using Flow Sensors with Serviceman Meters.

Hand-held diagnostic meter to measure pressure, temperature, flow and rotational speed for hydraulic and pneumatic systems

- Easy operation
- Rugged design
- Large display
- Auto sensor recognition
- MIN/MAX Memory
- On-line operation
- Multiple sensor inputs
- Battery monitoring
- Analog output



The ServiceMaster™ meter is a state-of-the-art instrument designed to provide the latest in diagnostic evaluation in hydraulic and pneumatic systems. These units are available in either three or six channel models. The new ergonomically designed case and large automatic scaling LCD display make it easy to use in even the most demanding environments.

These hand held meters provide measurement and display of pressure, temperature, flow, differential pressures, as well as rotational speed. They are the perfect tool to capture diagnostic measurements at remote locations. Also new to these meters are the functions for calculating power and flow run-out.

The meters are designed to offer a dramatic increase in data storage capability. The SCM-350 offers 125,000 data points and the top-of-the-line SCM-450 now offers 250,000 data points of storage. These measurements can be transferred to a PC via an RS232 interface and the new SensoWin™ 4.0 software. This software is compatible with all Windows95, Windows98, and WindowsNT operating systems.

As with all SensoControl® equipment, the ServiceMaster offers the latest in sensor recognition technology, eliminating the time consuming task of programming each individual sensor. This technology allows you to just plug in the sensor, and you are ready

to take measurements. The ServiceMaster™ meter also allows you to program the individual inputs to accept other data collection formats, such as 4-20 ma, 0-10 Volt, or frequency.

Parker Hannifin provides the most complete line of hydraulic and pneumatic diagnostic equipment available today. For more information or to receive a full demonstration, contact the Quick Coupling Division or your local distributor.

SensoControl® ServiceMaster™
Measure and Document Flow, Pressure, Voltage, Current
Temperature and Rotation Speed

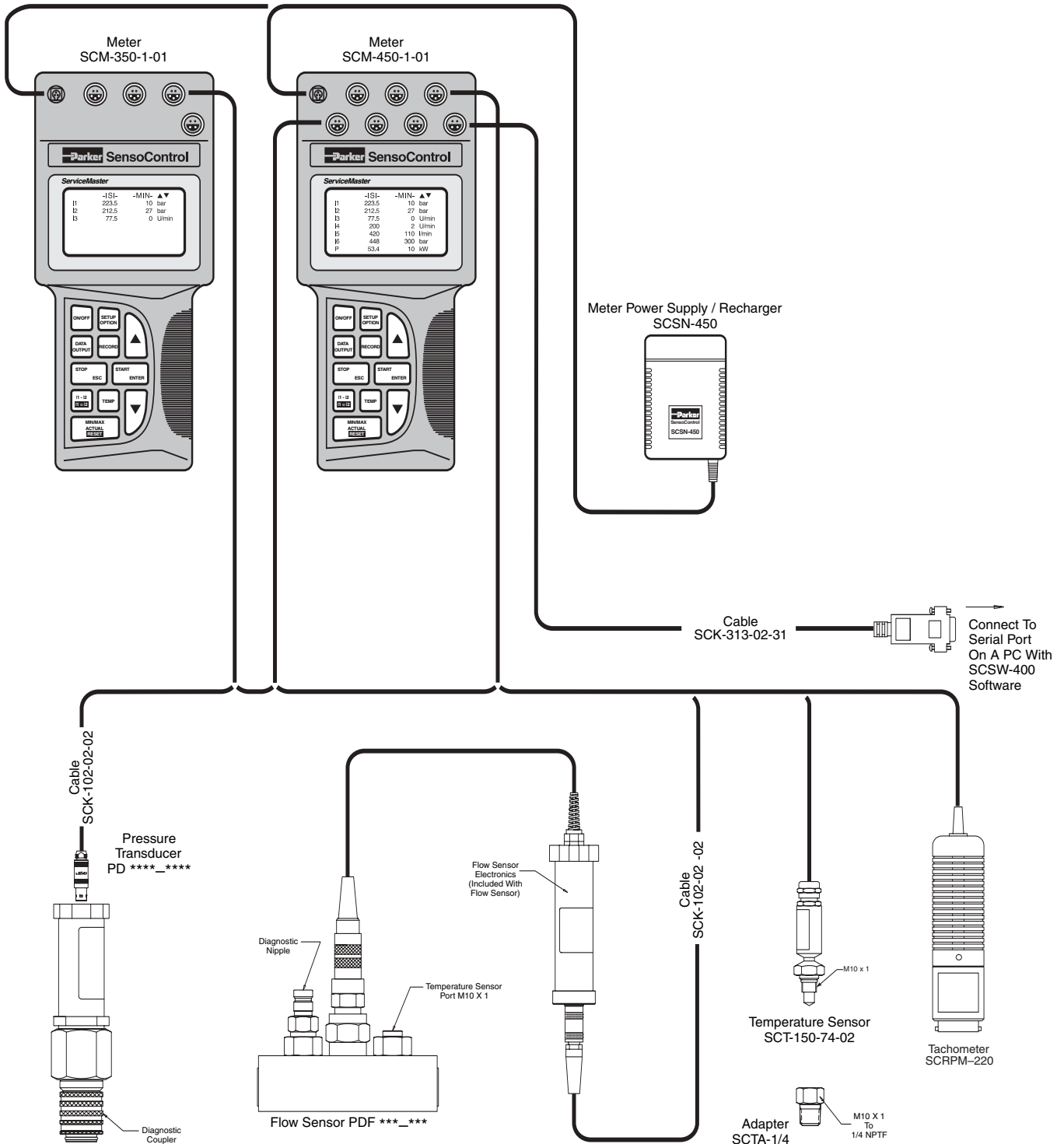

F Diagnostic

Meter

- Digital LCD Text Display
-128x64 pixels
- Automatic Character Height Scaling
- Display of Pressure, Temperature, Flow and Rotational Speed
 - Pressure in PSI and Bar
 - Temperature in °F and °C
 - Flow in GPM and l/min.
 - Rotational Speed in RPM

Inputs

- 3 or 6, 5-pin push-pull style connectors
- Automatic Sensor Recognition
- 0-3 Volts (R=470 kΩ)
- 12 Bit A/D Converter
- 1 ms Scanning Rate (1-3 inputs)
- 2 ms Scanning Rate (4-6 inputs)
- Frequency input via Input socket I3
- frequency range 0.5 Hz to 30 kHz

Functions

- Differential Value Measurement
- MIN/MAX Memory
- Online data transfer
- Battery level indicator
- Power calculation (display only)
- Flow run-out (display only)
- Auto power off

Output

- RS232 interface
- Adjustable baud rate up to 38400 BPS
- 8 data bits, 1 stop bit

Power Requirements

- Internal 7.2-volt rechargeable Ni-Cad battery
- Recharge circuit for use with external power supply.
- Operating time (Aprox. 5 hours)
- Excitation voltage (12-30 VDC)

Memory Functions

- Memory capacity
-125,000 data points (SCM-350)
-250,000 data points (SCM-450)
- Memory used in 25,000 data point intervals
- Variable storage rate
- Variable measuring period up to 100 hours
- Manual and automatic triggering

Ambient Conditions

- Operating Temperatures
32°F to 122°F (0°C to 50°C)
- Storage Temperatures
-4°F to 140°F (-20°C to 60°C)
- Protection class IP54

Housing

- Glass reinforced polyamide
- 11-Key tactile touch membrane
- EMC Protection
 - Electromagnetic interference (DIN/EN 50081, Part 1)
 - Immunity to emitted interference (DIN/EN 50082, Part 2)

General Information

Dimensions

- Length/Height/Width
- 9.25 x 4.19 x 2.09
(235 x 106 x 53 mm)

Weight

- 1.2 lbs (700 grams)

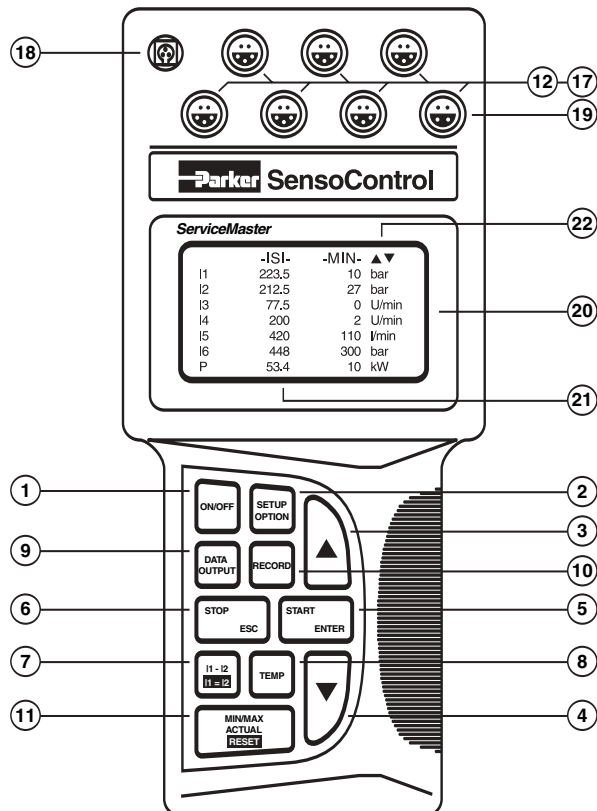

Functions

- 1 ON/OFF** Turns meter on or off
- 2 SETUP/OPTION** Change system settings
- 3/4 ARROWS** Select line and function values
- 5 START/ENTER** Change function values and start measurements
- 6 STOP/ESC** Stop or terminate functions
- 7 I1-I2** Differential value between input 1 and input 2.
- 8 TEMP** Displays the measured temperature values for all channels
- 9 DATA-OUTPUT** Displays output to PC, printer or graphic display
- 10 RECORD** To record and store measurements
- 11 MIN/MAX/ACTUAL** Displays the minimum, maximum and actual values. Reset deletes values
- 12-17 INPUTS** Inputs for up to (6) sensors
- 18 11-30 VDC** Input for external power supply and charging of internal battery
- 19 DATA OUTPUT** RS232 port for connecting to the PC, printer, or external trigger module
- 20 GRAPHIC LCD** Displays measured values, adjustment menus and graphics.
- 21 ADDITIONAL LINE** Displays the power or flow runout values.
- 22 STATUS LINE** Shows the designation of the measured value or the menu name.

F Diagnostic

Features

- Five measurement ranges (Vacuum to 8700 PSI)
- Color coded for easy identification
- Corrosion proof stainless steel housing
- Accuracy of .5% Full Scale (FS)



Transducer Technical Data

	PD ** -0100	PD ** -0600	PD ** -1500	PD ** -4000	PD ** -6000
Measuring Range (Pressure)	-14.5 to 145	0 to 870	0 to 2175	0 to 5800	0 to 8700 ⁽¹⁾
Color Code	Blue	Green	Yellow	Orange	Red
Measuring Range (Temp.)	-13°F to 221°F	-13°F to 221°F	-13°F to 221°F	-13°F to 221°F	-13°F to 221°F
Max. Overload Pressure	290	1450	3625	14500	14500
Output Signal (Volts)	-0.2 to 2	0 to 3	0 to 3	0 to 3	0 to 3
Hysteresis (% FS Typical)	0.1	0.05	0.1	0.08	0.05
Repeatability (%FS Typical)	0.08	0.13	0.13	0.1	0.1
Non-conformity (%FS)	0.25	0.2	0.2	0.28	0.25
Response Time	1 ms	1 ms	1 ms	1 ms	1 ms
Excitation Voltage	7-12 VDC	7-12 VDC	7-12 VDC	7-12 VDC	7-12 VDC

(1) Maximum Rated Pressure for PD Series Couplers is 6000 psi.

Materials of Construction

TransducerStainless steel
 DiaphragmStainless steel
 Coupler.....Zinc Plated steel
 Seal.....Fluorocarbon

Temperature Range

Working.....-4° to 185°
 Fluid-13° to 221°
 Storage-40° to 257°

Output

Accuracy.....0.5% FS
 Load2m ohms
 Response time1 ms
 Output signal to noise0.1%FS
 Resonant frequency100 Hz

Voltage Requirement

7 to 12 VDC excitation voltage
 Permissible ripple±2% ss
 Current requirement5 mA

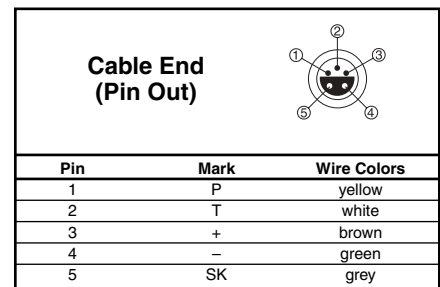

Order Code

Order No.	Description
SCM-350-1-01	ServiceMaster hand-held meter, 3 Inputs, 125,000 data points (includes SCSN-450)
SCM-450-1-01	ServiceMaster hand-held meter, 6 Inputs, 250,000 data points
SC-690	Case for ServiceMaster 350/450 meter kits
SCSN-450	120 Volt AC power supply/recharger for ServiceMaster 350/450 meters
SCK-102-02-02	Connection cable between the meter and the sensors (2 m length)
SCK-102-03-12	Extension cable to be used in series with standard cables (3 m length)
SCK-102-05-02	Extended version of cable between the meter and the sensors (5 m length)
SCG-022	Replacement paper for thermal printer SCPR-100-1-01
SCSW-400	SensoWin™ 4.0 software for data transfer to the PC (Windows 98 and newer)
SCK-313-02-31	Data cable between the RS232 meter port and a PC
SCRPM-220	Tachometer to be used to measure rotational speed (0 to 10,000 RPM)
SCRPMA-001	Contact adapter for SCRPM-210 tachometer
SCRPMA-002	Focus adapter for SCRPM-210 tachometer
SCDA-410	Adapter kit for desk top printers. Compatible with Cannon BJC 8S or HP HP340 or equivalent
PDH-19	Diagnostic test hose assembly (.5 m length extension hose assembly used with PD transducers and diagnostic nipples)
PD288	PD style pressure transducer adapter
PDP288	PDP style pressure transducer adapter
SCA-1/2-EMA-3	EMA3 female pressure transducer
SCA-1/2-EMA-3-S	EMA3 male pressure transducer
SCT-150-74-02	Temperature sensor used with the PDF flow sensors or with the SCTA-1/4 port adapter
SCTA-1/4	Port adapter to convert M10 X 1 to NPT for use with the SCT-150-74-02 Transducer Adapters
SCMA-VADC-250	Voltage Adapter for use with Auxiliary Sensors

SCRPM Tachometer



Part Number	Connector	Compatibility
SCRPM-220	5-pin push-pull style	ServiceMaster™

Accessories

Part Number	Description
SCRPMA-001	Contact adapter for belt drive/wheel
SCRPMA-002	Focus adapter for confined areas

The **SCRPM Tachometer** provides precision measurement of rotational speed. This sensor emits a light beam through an LED source. This light source is reflected and picked up as a pulse. It is then converted to an analog signal and displayed on the hand held meter.

Technical Data

Measuring Range	20 – 10,000 RPM
Measuring Distance	0.1 – 19.5 inches
Accuracy.....	0.5%
Excitation Voltage.....	7 – 9 VDC
Output Signal	0 – 3 VDC
Resolution	5 RPM

5 pin to 5 pin Cable



Part Number
SCK-102-02-02

Description
Flow Sensor and Transducer Cable to ServiceMaster™

Temperature Sensor



Part Number
SCT-150-74-02

Description
ServiceMaster™ Temperature Sensor

Voltage Adapter



Part Number
SCMA-VADC-250

Description
For Use with Auxiliary Sensors to ServiceMaster
Input: 0 - 20 MA or 0 - 10 VDC
Accuracy: 0.25% FS

Test Meter Kits



Kit Contents:

- Case
- ServiceMaster Meter
- Transducers (Quantity 2)
- Transducer Cable, 6.5' (Quantity 2)
- Power Supply – Meter
- SensoWin Software 4.0
- Computer Interface Cable
- Operating Manual*

* Included with ServiceMaster Meter

**ServiceMaster 350
Meter Kit**

- SC-690
- SCM-350-1-01
(See Below)
- SCK-102-02-02
- SCSN-450
- SCSW-400
- SCK-313-02-31

**ServiceMaster 450
Meter Kit**

- SC-690
- SCM-450-1-01
(See Below)
- SCK-102-02-02
- SCSN-450
- SCSW-400
- SCK-313-02-31

Code for Ordering

ServiceMaster Meter Kits:

PDSM XX - X - XX - XX

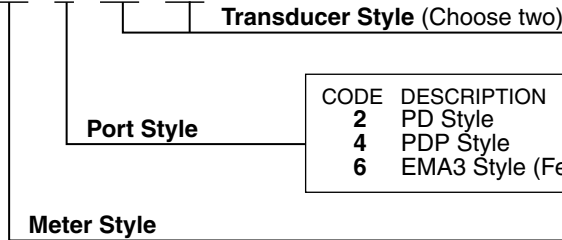

Transducer Style (Choose two)

Port Style

Meter Style

CODE	DESCRIPTION
2	PD Style
4	PDP Style
6	EMA3 Style (Female)

CODE	PRESSURE	COLOR
01	-14.5 – +145 PSI	Blue
06	0 – 870 PSI	Green
15	0 – 2175 PSI	Yellow
40	0 – 5800 PSI	Orange
60	0 – 8700 PSI	Red

CODE	DESCRIPTION
35	ServiceMaster 350 Meter
45	ServiceMaster 450 Meter

Code for Ordering

Additional Transducers Separately:

PD XXXXXX - XXXX

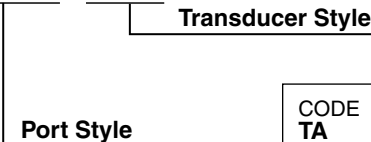

Transducer Style

Port Style

CODE	DESCRIPTION
TA	PD Style
PTA	PDP Style
TEMA3	EMA3 Style (Female)

CODE	PRESSURE	COLOR
0100	-14.5 – +145 PSI	Blue
0600	0 – 870 PSI	Green
1500	0 – 2175 PSI	Yellow
4000	0 – 5800 PSI	Orange
6000	0 – 8700 PSI	Red

Code for Ordering

Flow Sensors (Generation II) Separately:

PDF XXX - XXXX

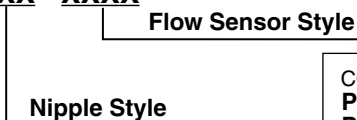

Flow Sensor Style

Nipple Style

CODE	DESCRIPTION
PD	PD Style
PDP	PDP Style
EMA	EMA Style

CODE	FLOW RATE
0004	.25 – 4 GPM (1.0 – 15 L/Min)
0216	2 – 16 GPM (7.5 – 60 L/Min)
0480	4 – 80 GPM (15 – 300 L/Min)
7160	7 – 160 GPM (25 – 600 L/Min)

Description

The SensoControl® Generation II flow sensors are a compact light-weight aluminum diagnostic tool capable of measuring pressure, temperature and flow from a single test point in a hydraulic system.

The Generation II flow sensors are designed to be used with a wide variety of hydraulic fluids. This design also minimizes the effect of viscosity changes. These units are manufactured from solid aluminum bar stock and are rated to 5800 PSI* and temperatures of 0°F +350°F. They are available in four sizes with flow measuring ranges from .25 – 160 GPM.

Generation II flow sensors are provided with a choice of PD, PDP or EMA style diagnostic ports and are designed to be used with Serviceman™ and ServiceMaster™ equipment.



Technical Data

Pressure Rating*.....5800 PSI
 * PDF-7160 is rated to 5000 psi
 Fluid Temperature Range.....0°F to +350°F
 Ambient Temperature Range0°F to +120°F
 Media/Compatibility.....Petroleum Based Fluids
 (Contact factory for use with water based hydraulic fluids)
 Flow Measurement Accuracy.....±2.0% Full Scale
 Voltage Input.....+7 to 12 VDC
 (Supplied by SensoControl meter)
 Current Requirement6mA

Material Specifications

Flow Block Anodized Aluminum
 Turbine Stainless Steel
 BearingsStainless Steel
 Seal MaterialNitrile
 Electrical Connection5 Pin Push-Pull Style

Performance

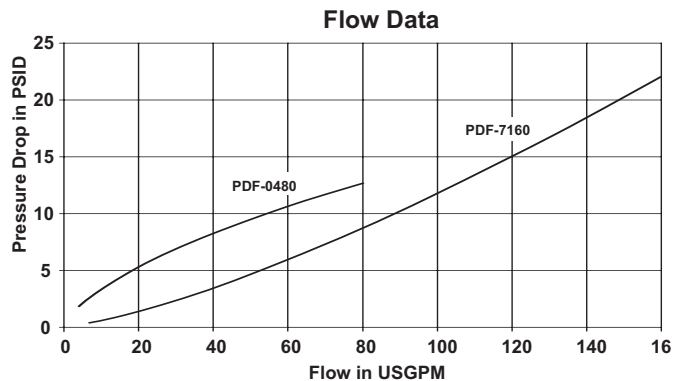
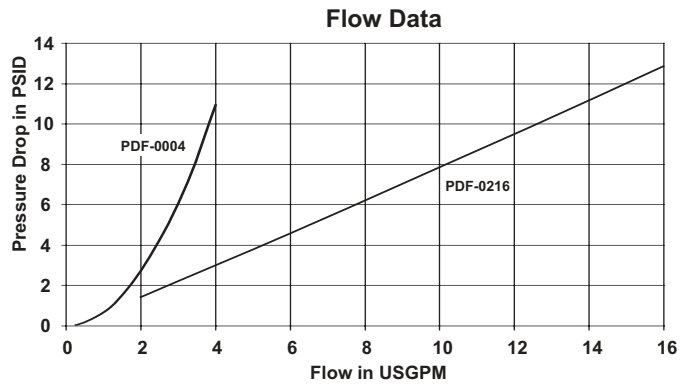

How to Order

Measuring Range	Flow Sensor with PD Nipple	Flow Sensor with PDP Nipple	Flow Sensor with EMA Nipple	Inlet/Outlet Port Configuration	Length inches	Height inches	Width inches
.25 GPM to 4 GPM (1.0 to 15 l/min)	PDFPD-0004	PDFPDP-0004	PDFEMA-0004	3/4-16 ORB	4.72	3.72	1.23
2 GPM to 16 GPM (7.5 to 60 l/min)	PDFPD-0216	PDFPDP-0216	PDFEMA-0216	1 1/16-12 ORB	5.08	4.05	1.48
4 GPM to 80 GPM (15.0 to 300 l/min)	PDFPD-0480	PDFPDP-0480	PDFEMA-0480	1 5/16-12 ORB	5.87	4.46	1.98
7 GPM to 160 GPM (25.0 to 600 l/min)	PDFPD-7160	PDFPDP-7160	PDFEMA-7160	1 5/8-12 ORB	6.81	4.75	2.46





Features

- Flush-face poppet valves minimize air inclusion and spillage, provide easy-to-clean surfaces, and help to prevent contamination.
- Grip-tight knurled sleeves help to make connecting and disconnecting easy, even while wearing gloves.
- Nipples are machined from high tensile steel for strength to withstand 6000 PSI continuous operating pressure. BPD nipples offer features similar to the standard steel PD nipples with the added feature of a brass body.
- PD nipples are designed to meet or exceed SAE J1502 and ISO 15171-1 design and performance specifications.
- End connections include pipe, O-ring, metric thread, bulkhead, 37° Flare, ORFS and bite-type.

Applications

PD Series couplings provide easy connection for mechanical gauges or specialized diagnostic equipment like SensoContro®.

Typically, PD or BPD nipples are permanently mounted in the system at threaded test ports, in rigid tubing or in hose assemblies. PD couplers are attached to test instruments.

Couplers align to the mating nipples without threading. This allows gauges, transducers and other test equipment to be snapped into place without difficulty.

Note: Protective dust plugs and caps play a crucial role in the life of a quick coupling and no purchase of a hydraulic quick coupling is complete without the selection of an appropriate dust plug and cap. See pages noted in Table of Contents for dust plugs and caps for the Parker full line of hydraulic couplings.

Ordering information

Coupler/Nipple Material	
• Prefix "B" for Brass body	
• Prefix "SS" for Stainless Steel body	
• Standard body material is Steel	

Optional Seals Suffix*				
No suffix is required when ordering products with the standard Nitrile seals. When specifying an optional seal, refer to the following chart to determine the appropriate suffix.**				
Coupling Series	Ethylene Propylene	Fluoro-carbon	Neoprene	Perfluoro-elastomer
PD Series	W	Y	Z	
PDP Series	W	Y	Z	

*To select proper seal materials, see Fluid Compatibility Chart in Appendices section, or contact your Parker Quick Coupling Distributor.

**N/A = Not Available; STD = Standard (No Suffix Needed)

Specifications

Body Size	1/8			
	PD Coupler	PD Nipple	BPD Nipple	Assembly
Description	PD242	PD361	BPD343Y	—
Part Number	PD242	PD361	BPD343Y	—
Body Material (Steel)	Carbon Steel	High Tensile Steel	Brass	—
Rated Pressure (PSI)	6000	6000	300	6000
Temperature Range (STD Seals) Nitrile	-40°F to +250°F		-15°F to +400°F (Fluorocarbon)	-40°F to +250°F
Rated Flow (GPM)	—	—	—	0.8
Max. Recommended Flow (GPM)	—	—	—	4.0
Burst Pressure (PSI/Min)	23,000	40,000	—	17,000
Vacuum Data (Inches Hg)	27.5	27.5	27.5	27.5
Pressure Drop at Rated Flow (PSI) with 200 SUS Fluid	—	—	—	56
Spillage at 15 PSI (ml)-Assembly	0.1 per disconnect			
Air Inclusion (ml)-Assembly	0.02 per connect			
Connect Force-Assembly	41 Lbs. (100 PSI)			
Disconnect Force-Assembly	20 Lbs. (100 PSI)			

PD Series DUST CAP



Body Size (in.)	Dust Cap Part No.
1/8	PD6-285

Couplers

Female Thread

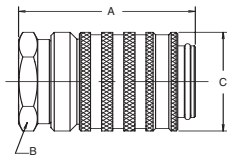

Body Size (in.)	Part No.	Female Thread NPTF	Female Thread ORB	Dimensions (in.)			Wt. (LB.) P/Piece
				Overall Length	Wrench Flats	Largest Diameter	
				A	B	C	
1/8	PD222	1/8-27	—	1.67	0.81	0.96	0.20
1/8	PD240	—	7/16-20	2.12	0.81	0.96	0.26
1/8	PD242	1/4-18	—	2.12	0.81	0.96	0.25
1/8	SSPD242Y**	1/4-18	—	2.12	0.81	0.96	0.25
1/8	PD260	—	9/16-18	2.12	0.81	0.96	0.24

Male Thread

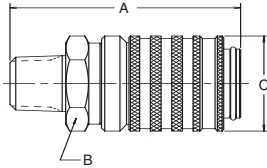

Body Size (in.)	Part No.	Male Thread NPTF	Male Thread ORB	Dimensions (in.)			Wt. (LB.) P/Piece
				Overall Length	Wrench Flats	Largest Diameter	
				A	B	C	
1/8	PD243	1/4-18	—	2.26	0.81	0.96	0.23

Nipples

Female Pipe Thread

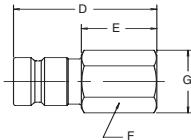

Body Size (in.)	Part No.	Thread Size NPTF	Overall Length	Exposed Length	Dimensions (in.)			Wt. (LB.) P/Piece
					Hex Size	Largest Diameter		
				D	E	F	G	
1/8	PD322	1/8-27	1.48	0.78	0.56	0.65	0.06	
1/8	PD342	1/4-18	1.63	0.93	0.75	0.87	0.12	

Male Pipe Thread

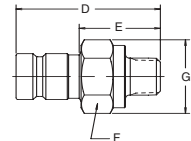

Body Size (in.)	Part No.	Thread Size NPTF	Overall Length	Exposed Length	Dimensions (in.)			Wt. (LB.) P/Piece
					Hex Size	Largest Diameter		
				D	E	F	G	
1/8	PD323	1/8-27	1.55	0.85	0.69	0.79	0.17	
1/8	BPD323Y*	1/8-27	1.44	0.74	0.63	0.72	0.17	
1/8	BPD343Y*	1/4-18	1.48	0.78	0.69	0.79	0.06	
1/8	PD343	1/4-18	1.48	0.78	0.69	0.79	0.06	
1/8	SSPD343Y**	1/4-18	1.48	0.78	0.69	0.79	0.06	
1/8	PD363	3/8-18	1.50	1.13	0.81	0.96	0.09	

Metric Thread

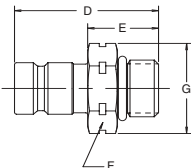

Body Size (in.s)	Part No.	Thread Size Metric	Overall Length	Exposed Length	Dimensions (in.)			Wt. (LB.) P/Piece
					Hex Size	Largest Diameter		
				D	E	F	G	
1/8	PD357	M10 x 1.0	1.80	1.10	0.69	0.79	0.17	
1/8	PD367C	M14 x 1.5	1.50	0.80	0.75	0.87	0.08	
1/8	PD3107	M16 x 1.5	1.54	0.84	0.88	1.01	0.08	
1/8	PD3127	M18 x 1.5	1.60	0.90	0.94	1.08	0.09	
1/8	PD3147	M20 x 1.5	1.50	0.80	0.75	0.87	0.07	

Male Straight Thread

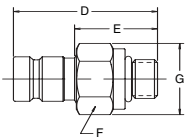

Body Size (in.)	Part* No.	Thread Size ORB	Overall Length	Exposed Length	Dimensions (in.)			Wt. (LB.) P/Piece
					Hex Size	Largest Diameter		
				D	E	F	G	
1/8	PD331	3/8-24	1.80	1.10	0.69	0.79	0.17	
1/8	PD341	7/16-20	1.60	0.90	0.69	0.79	0.08	
1/8	PD351	1/2-20	1.32	0.62	0.63	0.72	0.05	
1/8	PD361	9/16-18	1.32	0.62	0.69	0.79	0.06	

* Note: Add -6 to part number to include dust cap, for example PD343-6

* BPD designates brass body, Fluorocarbon seal standard

** SSPD designates 316SS body, Fluorocarbon seal standard

Nipples

Bulkhead Triple-Lok

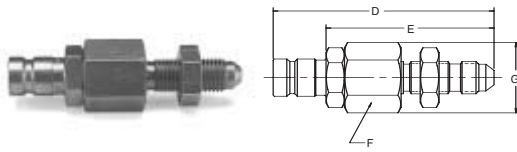

Body Size (in.)	Part No. Steel	Thread Size	Tube Size	Dimensions (in.)				Wt. (LB.) P/Piece	
				Overall Length	Exposed Length	Hex Size	Largest Diameter		
				D	E	F	G		
1/8	PD345	7/16-20	1/4	2.92	2.22	0.81	0.94	0.19	
1/8	PD355	1/2-20	5/16	2.92	2.22	0.81	0.94	0.19	
1/8	PD365	9/16-18	3/8	3.00	2.30	0.81	0.94	0.20	

Bulkhead Seal-Lok

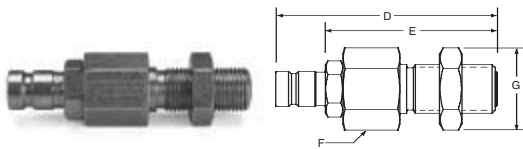

Body Size (in.)	Part No. Steel	Thread Size	Tube Size	Dimensions (in.)				Wt. (LB.) P/Piece	
				Overall Length	Exposed Length	Hex Size	Largest Diameter		
				D	E	F	G		
1/8	PD346	9/16-18	1/4	2.98	2.27	0.81	0.94	-	
1/8	PD366	11/16-16	3/8	3.08	2.37	1.00	1.16	-	
1/8	PD386	13/16-16	1/2	3.18	2.47	1.12	1.30	-	

Tube End Nipples*

Triple-Lok
PD — — BTX

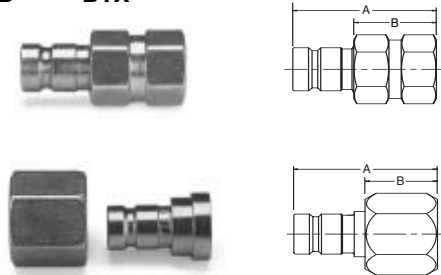

Body Size (in.)	Part No. Steel	Tube Size	Dimensions (in.)		Wt. (LB.) P/Piece	
			Overall Length	Exposed Length		
			A	B		
1/8	PD34BTX	1/4	1.64	0.94	0.10	
1/8	PD36BTX	3/8	1.66	0.96	0.09	
			A	B		
1/8	PD38BTX	1/2	1.17	0.47	0.12	
1/8	PD312BTX	3/4	1.39	0.69	0.27	

* Tube end nipples are designed to meet the performance standards of the tube or hose fitting connection, which may or may not meet SAE J1502 Standards.

Ferulok
PD — — BTU



Body Size (in.)	Part No. Steel	Tube Size	Dimensions (in.)		Wt. (LB.) P/Piece	
			Overall Length	Exposed Length		
			A	B		
1/8	PD38BTU	1/2	1.40	0.70	-	

* Tube end nipples are designed to meet the performance standards of the tube or hose fitting connection, which may or may not meet SAE J1502 Standards.

Seal-Lok
PD — — BTL

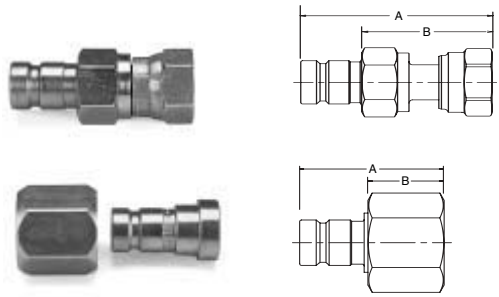

Body Size (in.)	Part No. Steel	Tube Size	Dimensions (in.)		Wt. (LB.) P/Piece	
			Overall Length	Exposed Length		
			A	B		
1/8	PD34BTL	1/4	2.18	1.48	0.12	
1/8	PD36BTL	3/8	2.30	1.60	0.14	
			A	B		
1/8	PD38BTL	1/2	1.12	0.42	0.13	
1/8	PD310BTL	5/8	1.16	0.46	0.19	

* Tube end nipples are designed to meet the performance standards of the tube or hose fitting connection, which may or may not meet SAE J1502 Standards.

Note: Add -6 to part number to include dust cap, for example PD343-6



Features

- Made to connect under pressure up to 6000 psi
- Grip-tight knurled sleeves help to make connecting and disconnecting easy, even while wearing gloves.
- Nipples are machined from high tensile steel for strength to withstand 6000 PSI continuous operating pressure.
- End connections include pipe, O-ring, 37° Flare and ORFS
- Durable Ball Valve Nipple.
- Coupler is unvalved to allow gauges and transducers to return to zero when disconnected.

Specifications

Body Size		1/8"	
Description	PDP Coupler	PDP Nipple	Assembly
Body Material (Steel)	Carbon Steel	High Tensile Steel	—
Rated Pressure (PSI)	—	6000	6000
Temperature Range (STD Seals) Nitrile	-40°F to +250°F		
Connect Force-Assembly	6 Lbs (0 PSI - 6000 PSI)		
Disconnect Force-Assembly	7 Lbs (0 PSI - 6000 PSI)		

Coupler (connect-under-pressure)

Female Thread

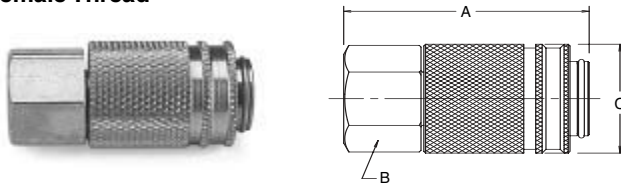

Applications

The PDP Series couplings provide easy connection for mechanical gauges or specialized diagnostic equipment like SensoControl.

Typically, PDP nipples are permanently mounted in the system at threaded test ports, in rigid tubing or in hose assemblies. PDP couplers are attached to test instruments.

Locking balls align the couplers to the mating nipples without threading, so gauges, transducers and other test equipment can be snapped into place without difficulty.

Parker's PDP Series couplings offer the advantages of PD couplings, but are designed to connect easily and quickly under full system pressure up to 6000 PSI (operating).

PDP couplers and nipples push to connect with a constant force of only six pounds. Then the coupler base is turned to open the valve and complete the connection. In the connected position, the coupler base blocks the retracting sleeve to prevent accidental disconnects.

Ordering information

Coupler/Nipple Material
Standard body material is steel.

Optional Seals Suffix*				
No suffix is required when ordering products with the standard Nitrile seals. When specifying an optional seal, refer to the following chart to determine the appropriate suffix.**				
Coupling Series	Ethylene Propylene	Fluoro-carbon	Neoprene	Perfluoro-elastomer
PD Series	W	Y	Z	
PDP Series	W	Y	Z	

*To select proper seal materials, see Fluid Compatibility Chart in Appendices section, or contact your Parker Quick Coupling Distributor.

**N/A = Not Available; STD = Standard (No Suffix Needed)

Body Size (in.)	Part No. Steel	Thread Size NPTF	Dimensions (in.)			Wt. (LB.) P/Piece
			Overall Length	Wrench Flats	Largest Diameter	
			A	B	C	
1/8	PDP242	1/4-18	2.15	0.81	0.96	—

PDP Series DUST CAP



Body Size (in.)	Dust Cap Part No.
1/8	PD6-285



Features

- Knurled sleeve allows simple twist-to-connect operation without the use of tools
- Rugged design allows connect-under-pressure operation up to 5800 psi
- Maximum rated working pressure of 9000 psi exceeds the requirements of most applications
- Integral threaded dust cap protects the test point from damage and contamination
- EMA fittings are machined from solid barstock and protected with zinc plating and a chromium 6 free finish.
- Stainless steel springs for corrosion resistance
- Elastomeric interface and valve seals provide leak free operation
- Compact design and optional high pressure hose assemblies provide flexibility for tight space requirements

Applications

EMA couplings provide easy diagnostic connections for Parker SensoControl® equipment or mechanical gages. EMA test points are typically permanently plumbed into a fluid system at locations where pressure measurements are required for maintenance or testing. Integral pressure cap protects the test point from damage and prevents contamination of the fluid system. Proven twist-to-connect design allows the test points to be connected even when the system is in operation and the test points are pressurized. EMA's compact design and optional high pressure hose assemblies allow extra flexibility for the location of system test points.

Although designed primarily for diagnostic applications, EMA fittings and hose assemblies are ideal for a wide range of applications that require compact high pressure connections and limited flow rates.

Specifications

Body Size	1/8
Rated Pressure (PSI)	9000 PSI
Max Connect-Under-Pressure (PSI)	5800
Rated Flow (GPM)	0.8
Body Material	Zinc Plated Steel
Seal Material (std.)	Nitrile/Fluorocarbon
Temperature Range (std. seals)	-15° to +250° F

Male Pipe Thread

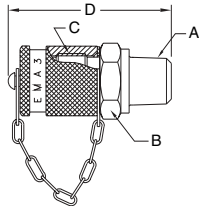

Part No.	Port Thread Size	Hex Size (mm)	Interface Thread Size	Overall Length	Wt. (LB.) P/Piece
	A	B	C	D	
EMA3/1/8NPT	1/8-27NPT	17	M16X2.0	1.81	0.15
EMA3/1/4NPT	1/4-18NPT	17	M16X2.0	1.98	0.16
EMA3/1/4NPT71	1/4-18NPT	17	M16X2.0	1.95	0.16

Stainless Steel

SAE Straight Thread

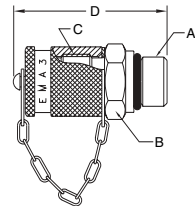

Part No.	Port Thread Size	Hex Size (mm)	Interface Thread size	Overall Length	Wt. (LB.) P/Piece
	A	B	C	D	
EMA3/7/16-20UNF-2A*	7/16-20UNF-2A	17	M16X2.0	1.88	0.15
EMA3/9/16-18UNF-2A*	9/16-18UNF-2A	19	M16X2.0	1.88	0.17

* O-Ring seal on port

Metric Straight Thread

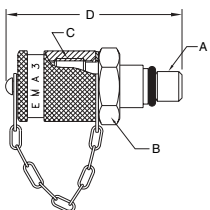

Part No.	Port Thread Size	Hex Size (mm)	Interface Thread Size	Overall Length	Wt. (LB.) P/Piece
	A	B	C	D	
EMA3/M8X1OR*	M8X1	17	M16X2.0	1.81	0.15
EMA3/10X1ED**	M10X1	17	M16X2.0	1.85	0.15
EMA3/12X1.5ED**	M12X1.5	17	M16X2.0	1.94	0.16
EMA3/14X1.5ED**	M14X1.5	19	M16X2.0	1.94	0.16

* O-Ring seal on port

** Molded seal on port

British Parallel Pipe

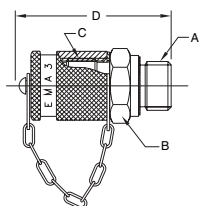

Part No.	Port Thread Size	Hex Size (mm)	Interface Thread Size	Overall Length	Wt. (LB.) P/Piece
	A	B	C	D	
EMA3/1/8ED**	1/8 BSPP	19	M16X2.0	1.77	0.15
EMA3/1/4ED**	1/4 BSPP	19	M16X2.0	1.94	0.16
EMA3/3/8ED**	3/8 BSPP	21	M16X2.0	1.94	0.16

** Molded seal on port



Nipples*
(connect-under-pressure)

Male Pipe

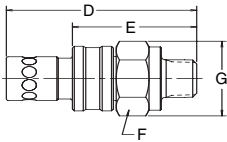

Body Size (in.)	Part No. Steel	Thread Size NPTF	Overall Length	Dimensions (in.)			Largest Diameter	Wt. (LB.) P/Piece
				Exposed Length	Hex Size	F		
			D	E	F	G		
1/8	PDP323	1/8-27	2.02	1.46	0.69	0.79	0.26	
1/8	PDP343	1/4-18	1.48	0.93	0.69	0.79	0.12	

Straight Thread

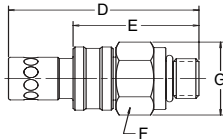

Body Size (in.)	Part No. Steel	Thread Size ORB	Overall Length	Dimensions (in.)			Largest Diameter	Wt. (LB.) P/Piece
				Exposed Length	Hex Size	F		
			D	E	F	G		
1/8	PDP341	7/16-20	2.06	1.50	0.69	0.79	0.12	
1/8	PDP361	9/16-18	1.48	0.93	0.69	0.79	0.07	

*Add -6 to part number to include dust cap.

Triple-Lok

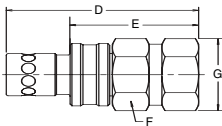

Body Size (in.)	Part No. Steel	Tube Size	Overall Length	Dimensions (in.)			Largest Diameter	Wt. (LB.) P/Piece
				Exposed Length	Hex Size	F		
			D	E	F	G		
1/8	PDP34BTX	1/4	2.11	1.55	0.69	.80	-	
1/8	PDP36BTX	3/8	2.13	1.57	0.69	.80	-	

Seal-Lok

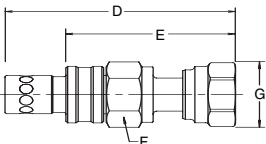

Body Size (in.)	Part No. Steel	Tube Size	Overall Length	Dimensions (in.)			Largest Diameter	Wt. (LB.) P/Piece
				Exposed Length	Hex Size	F		
			D	E	F	G		
1/8	PDP34BTL	1/4	2.65	2.09	.69	.80	-	
1/8	PDP36BTL	3/8	2.77	2.21	.81	.94	-	

F Diagnostic

EMA Gauge Adapter

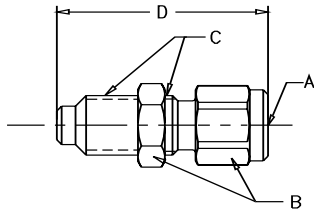

Part No.	Port Thread Size	Hex Size (mm)	Port Thread Size	Overall Length	Wt. (LB.) P/Piece
	A	B	C	D	
MAV1/4NPT-MA3	1/4-18NPT	19	M16X2.0	2.22	0.16
MAV1/4NPT-MA3-KM Includes Dust Cap	1/4-18NPT	19	M16X2.0	2.22	0.23

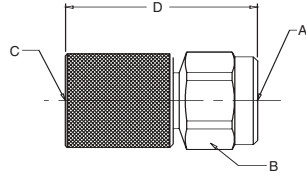

Part No.	Port Thread Size	Hex Size (mm)	Port Thread Size	Overall Length	Wt. (LB.) P/Piece
	A	B	C	D	
MAVMD1/4NPT-MA3	1/4-18NPT	19	M16X2.0	2.22	0.18

Union

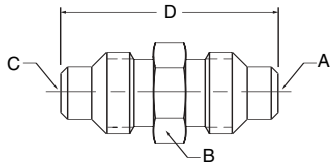

Part No.	Port Thread Size	Hex Size (mm)	Port Thread Size	Overall Length	Wt. (LB.) P/Piece
	A	B	C	D	
EMA3VS	M16X2.0	17	M16X2.0	1.65	0.11

F Diagnostic

Transducer Adapters 1/2-14BSPP Thread*

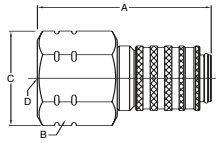

Part No.	Overall Length	Hex Size	Largest Diameter	Port Thread Size	Interface Thread Size	Wt. (LB.) P/Piece
	A	B	C	D	E	
PD288	2.52	1.19	1.38	1/2-14BSPP	-	0.35

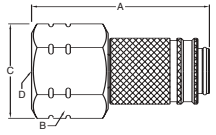

Part No.	Overall Length	Hex Size	Largest Diameter	Port Thread Size	Interface Thread Size	Wt. (LB.) P/Piece
	A	B	C	D	E	
PDP288	2.58	1.19	1.38	1/2-14BSPP	-	0.35

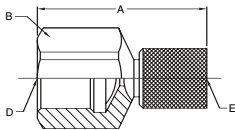

Part No.	Overall Length	Hex Size Metric	Largest Diameter	Port Thread Size	Interface Thread Size	Wt. (LB.) P/Piece
	A	B	-	D	E	
SCA-1/2-EMA-3	2.07	27mm	-	1/2-14BSPP	M16X2.0	0.30

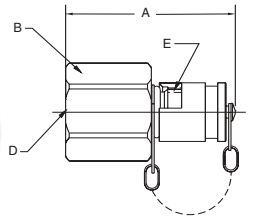

Part No.	Overall Length	Hex Size Metric	Largest Diameter	Port Thread Size	Interface Thread Size	Wt. (LB.) P/Piece
	A	B	-	D	E	
SCA-1/2-EMA-3-S	2.07	27mm	-	1/2-14BSPP	M16X2.0	0.30

* Note: For old style M22X1.5 thread contact the division

Flexible Hose

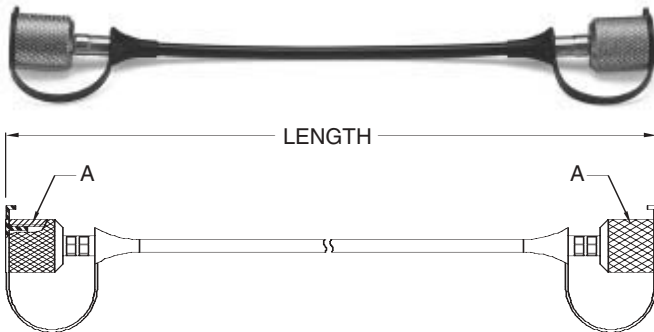

Part No.	Length (in.)	Length (mm)	Thread Size A
SMA3-200	7.90	200	M16x2.0
SMA3-400	15.75	400	M16x2.0
SMA3-800	31.50	800	M16x2.0
SMA3-2000	78.75	2000	M16x2.0
SMA3-4000	157.50	4000	M16x2.0

Note: Other lengths available upon request.
Maximum pressure rating for test hose is 9000 psi.



Features

These diagnostic fluid sampling products are designed to provide an easy access point for obtaining fluid samples. A permanently mounted test point eliminates the need to shut down or break lines when taking samples and reduces the chances of contamination. Fluid analysis is crucial in both engines and hydraulic systems as it can reveal problems with filtration and other internal components. Early detection can prevent costly repairs, unscheduled maintenance and production downtime. These fluid sampling nipples should be installed in either low pressure or return lines. For the most accurate monitoring, fluid samples should be constantly taken from the same location.

Specifications

Body Size (in.)	1/8
Rated Pressure (psi)	500
Temperature Range (std seals: Fluorocarbon)	-40° to +250°F
Seal material	Fluorocarbon



Couplers

Female Thread

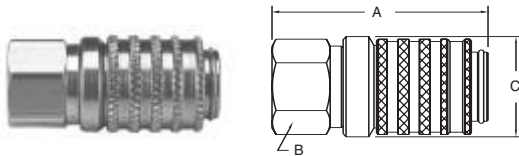

Body Size (in.)	Part No.	Female Thread NPTF	Female Thread ORB	Dimensions (in.)			Largest Wt. (LB.) P/Piece
				Overall Length	Wrench Flats	Diameter	
				A	B	C	
1/8	PDFS242	1/4-18	–	2.15	0.81	0.96	0.25

Nipples

Male Straight Thread

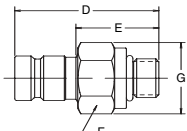

Male Pipe Thread

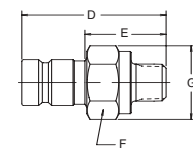

Metric Thread

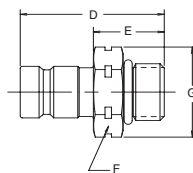

Body Size (in.)	Part No.	Thread Size ORB or NPTF	Thread Size METRIC	Dimensions (in.)				Largest Wt. (LB.) P/Piece
				Overall Length	Exposed Length	Hex Size	Diameter	
				D	E	F	G	
1/8	BPDFS341	7/16-20 ORB		1.60	0.90	0.69	0.79	0.08
1/8	BPDFS343	1/4-18 NPTF		1.48	0.78	0.69	0.79	0.06
1/8	BPDFS357		M10 x 1.0	1.80	1.10	0.69	0.79	0.17
1/8	PDFS-PROBE*		NA	–	–	–	–	–
1/8	PROBE HOLDER							

Fluorocarbon seal is standard.

Dust Cap PD6-285 is recommended.

* Reuseable PROBE HOLDER must be used with PDFS-PROBE

Sampling Kits

Note: When you purchase either of the sampling kits, you receive the PAR-Test™-complete laboratory analysis included in the initial cost. This includes particle count, viscosity, water content and spectra chemical analysis of over 20 wear metals and additives.

Body Size (in.)	Part No.	Description
1/8	PDFS-TEST	Sampling Kit
1/8	PDFS-TEST-P*	Sampling Kit W/Probe

Ordering Information

Diagnostic Products

When ordering Parker coupler bodies and nipples, please state the part number of each type of coupler body and each type of nipple desired. List coupler bodies and nipples as separate items rather than in combinations. Be sure to double check thread or hose sizes of items required.

Many of Parker's coupling products are available with unique non-standard options well suited to very specific applications. Examples of unusual end use applications might include: high temperatures (above 250° F), extremely caustic/corrosive solutions passing through the coupling, external/environmental corrosion situations, or other high wear and tear situations such as dragging the product along the ground. Please see the Fluid Compatibility Chart at the end of the catalog for a guide in selecting material for various media. It is always recommended that the Quick Coupling Division be contacted with any questions concerning specific product application needs.

Typically, a prefix or suffix is added to the base part number to specify a non-standard O-ring seal, or special option. The Optional Seals Suffix chart illustrates the designations.

Please Note: Certain couplings series have additional "Special Order Information" which should be referred to in ordering those products. If applicable to the product, "Special Order Information" is found next to the Features and Specifications charts.

Coupler/Nipple Material
<ul style="list-style-type: none"> • Prefix "B" for Brass body • Prefix "SS" for Stainless Steel body • Standard body material is Steel

Optional Seals Suffix*				
No suffix is required when ordering products with the standard Nitrile seals. When specifying an optional seal, refer to the following chart to determine the appropriate suffix.**				
Coupling Series	Ethylene Propylene	Fluoro-carbon	Neoprene	Perfluoro-elastomer
PD Series	W	Y	Z	
PDP Series	W	Y	Z	

*To select proper seal materials, see Fluid Compatibility Chart in Appendices section, or contact your Parker Quick Coupling Distributor.

**N/A = Not Available; STD = Standard (No Suffix Needed)

Diagnostic Products

Test Port Coupling-Selection Guide

	Valving	Body Size	Material* Br SS S P	Locking Mechanism	Std. Seal Material	Temp Range**	Rated Pressure
Test Port							
PD Series	Flush Face	1/8"	● ● ●	Ball	Nitrile	-40° to +250° F	6000 PSI
PDP Series	Ball	1/8"	●	Ball	Nitrile	-40° to +250° F	6000 PSI
EMA3 Series	Poppet	1/8"	● ●	Threads	Nitrile/Fluorocarbon	-15° to +250° F	9000 PSI

* See Fluid Compatibility chart and/or consult factory for questions regarding proper material for specific applications.

CODE: Br = Brass; SS = Stainless Steel; S = Steel; P = Plastic

**Temperature Range for standard seal material.

Note: See the Specifications Table for PD and PDP Series for more information.

SensoControl® diagnostic product's technical information subject to change.



Appendices

Ratings Code:

- G** – Good to excellent. Little or no swelling, tensile or surface changes. Preferred choice.
- L** – Marginal or conditional. Noticeable effects but not necessarily indicating lack of serviceability. Further testing suggested for specific application. Very long-term effects such as stiffening or potential for crazing should be evaluated.
- P** – Poor or unsatisfactory. Not recommended without extensive and realistic testing.
- – Indicates that this was not tested.
- #** – For Teflon. Indicates good chemical resistance but potential for excessive permeation.

MEDIA	Polypropylene	MEDIA	Polypropylene
Acetaldehyde	P	Glucose	G
Acetates	L	Glycerine	G
Acetic Acid	G	Hydriodic Acid	—
Acetic Anhydride	L	Hydrochloric Acid (Conc.)	G
Acetone	G	Hydrochloric Acid (Med. Conc.)	G
Acetyl Bromide	—	Hydrofluoric Acid	G
Acetyl Chloride	L	Hydrogen Peroxide (Conc.)	L
Air	G	Hydrogen Peroxide (Dil.)	L
Alcohols	L	Hydrogen Sulfide	G
Aluminum Salts	G	Iodine	G
Ammonia	G	KeroseneP	
Amyl Acetate	L	Ketones	G
Aniline	G	Lacquer Solvent	L
Animal Oils	G	Lactic Acid	G
Arsenic Salts	L	Lead Acetate	G
Aromatic Hydrocarbons	—	Linseed Oil	G
Barium Salts	G	Magnesium Salts	G
Benzaldehyde	L	Naphtha L	L
Benzene (Benzol)	L	Natural Gas	L
Benzyl Alcohol	G	Nickel Salts	G
Bleaching Liquors	—	Nitric Acid (Conc.)	P
Boric Acid Solution	G	Nitric Acid (Dil.)	L
Bromine	P	Nitrobenzene	G
Butane	L	Nitrogen Oxides	—
Butanol	—	Nitrous Acid	G
Butyl Acetate	P	Oils (Animal and Mineral)	L
Calcium Salts	G	Oils (Vegetable)	L
Carbon Dioxide	G	Oxygen	L
Carbon Disulfide	L	Perchloric Acid	L
Carbon Tetrachloride	P	Phenol	G
Caustic Potash	G	Potassium Salts	G
Caustic Soda	G	Pyridine	G
Chloracetic Acid	L	Silver Nitrate	G
Chlorine (Dry)	P	Soap Solutions	G
Chlorine (Wet)	P	Sodium Salts	G
Chlorobenzene	P	Stearic Acid	L
Chloroform	P	Sulfur Chloride	P
Chromic Acid	G	Sulfuric Acid (Conc.)	L
Copper Salts	G	Sulfuric Acid (Dil.)	G
Cresol	L	Sulfurous Acid	L
Cyclohexanone	L	Tannic Acid	G
Ethers	P	Tanning Extracts	L
Ethyl Acetate	L	Titanium Salts	—
Ethyl Alcohol	G	Toluene (Toluol)	P
Ethylamine	L	Trichloroacetic Acid	G
Ethyl Bromide	—	Trichlorethylene	P
Ethyl Chloride	P	Turpentine	P
Fatty Acids	G	Urea	G
Ferric Salts	G	Uric Acid	—
Formaldehyde	G	Water	G
Formic Acid	G	Xylene (Xylol)	P
Freon	L	Zinc Chloride	G
Gasoline	L		

Fluid Compatibility Chart

Appendices

Codes

The following seal compound and body material compatibility chart is provided as an aid in selecting a specific synthetic rubber compound or body material for a particular application. Operating and environmental conditions must be considered when making the selection of a quick coupling.

Refer to the appropriate section of the catalog for Ordering Information for Seal Codes for specific products.

To indicate a special material just add the appropriate code letter as a suffix to the catalog number of the coupler. It is not necessary to use the code "STD" as the standard Nitrile seal will be used when another code is not used.

For recommendations for media not listed below, please contact your Parker representative or the factory.

Note

This chart is intended as a guide only and is not be considered as a recommendation to use Parker quick action couplings in a specific application or with a specific fluid, other factors that must be considered include but are not limited to: fluid and ambient temperature, system pressure, both operating and peak, frequency of connect and disconnect, and applicable standards or regulations.

CODES: 1 = Satisfactory 2 = Fair 3 = Not Recommended 4 = Insufficient Data Available

MEDIA	BODY MATERIAL				SEAL MATERIAL			
	Brass	Steel	316 S.S.	303 S.S.	Nitrile	E.P.	Fluorocarbon	Neoprene
3M FC-75	4	4	4	4	1	1	2	1
ACETAMIDE	4	4	1	2	1	1	3	1
ACETIC ACID (5%)	3	3	1	1	2	1	1	1
ACETONE	1	2	1	1	3	1	3	3
ACETOPHENONE	2	2	2	1	3	1	3	3
ACETYL ACETONE	2	2	2	2	3	1	3	3
ACETYL CHLORIDE	4	2	2	2	3	3	1	3
ACETYLENE	3	2	1	1	1	1	1	2
AIR (200 DEGREES F.)	1	2	1	1	1	1	1	1
AIR (300 DEGREES F.)	1	2	1	1	2	2	1	2
AIR (400 DEGREES F.)	1	2	1	1	3	3	1	3
ALUMINUM ACETATE	4	4	4	4	2	1	3	2
ALUMINUM BROMIDE	4	4	4	4	1	1	1	1
ALUMINUM CHLORIDE (10%)	3	3	3	3	1	1	1	1
ALUMINUM CHLORIDE (100%)	3	2	2	2	1	1	1	1
ALUMINUM FLOURIDE	3	3	3	3	1	1	1	1
ALUMINUM NITRATE	3	3	2	2	1	1	1	1
ALUMINUM SALTS	4	4	4	4	1	1	1	1
ALUMINUM SULPHATE	2	3	2	3	1	1	1	1
ALUMS (NH ₃ ,Cr,K)	4	4	4	4	1	1	3	1
AMMONIA (ANHYDROUS)	3	2	1	1	2	1	3	1
AMMONIA (COLD, GAS)	3	2	4	1	1	1	3	1
AMMONIA (HOT, GAS)	3	2	4	1	3	2	3	2
AMMONIUM CARBONATE	3	2	3	3	3	1	1	1
AMMONIUM CHLORIDE	3	3	2	3	1	1	1	1
AMMONIUM HYDROXIDE	3	3	1	2	3	1	3	1
AMMONIUM NITRATE	3	3	1	1	1	1	4	1
AMMONIUM PERSULFATE SOLUTION	3	3	1	2	3	1	4	4
AMMONIUM PHOSPHATE (MONO-, DI-, TRI-BASIC)	3	3	3	2	1	1	4	1
AMMONIUM SALTS	4	4	4	4	1	1	3	1
AMMONIUM SULFATE	3	3	2	3	1	1	3	1
AMYL BORATE	4	4	4	4	1	3	1	1
AMYL CHLORIDE	4	2	1	1	4	3	1	3
AMYL CHLORONAPHTHALENE	4	4	4	4	3	3	1	3
AMYL NAPHTHALENE	4	4	4	4	3	3	1	3
ANIMAL OIL (LARD OIL)	2	2	2	2	1	2	1	2
AROCLOR 1248	2	3	3	3	3	2	1	3
AROCLOR 1254	2	3	3	3	3	2	1	3
AROCLOR 1260	2	3	3	3	1	4	1	1

Fluid Compatibility Chart

Appendices

CODES: 1 = Satisfactory 2 = Fair 3 = Not Recommended 4 = Insufficient Data Available

MEDIA	BODY MATERIAL				SEAL MATERIAL			
	Brass	Steel	316 S.S.	303 S.S.	Nitrile	E.P.	Fluorocarbon	Neoprene
AROMATIC FUEL - 50%	4	4	4	4	2	3	1	3
ARSENIC ACID	3	3	1	1	1	1	1	1
ASPHALT	3	3	1	1	2	3	1	2
ASTM OIL, NO. 1	1	1	1	1	1	3	1	1
ASTM OIL, NO. 2	1	1	1	1	1	3	1	2
ASTM OIL, NO. 3	1	1	1	1	1	3	1	3
ASTM OIL, NO. 4	1	1	1	1	2	3	1	3
ASTM REFERENCE FUEL A	3	2	1	1	1	3	1	2
ASTM REFERENCE FUEL B	3	2	1	1	1	3	1	3
ASTM REFERENCE FUEL C	3	2	1	1	2	3	1	3
AUTOMOTIVE BRAKE FLUID	4	4	4	4	3	1	3	2
BARIUM CHLORIDE	3	3	2	3	1	1	1	1
BARIUM HYDROXIDE	3	2	2	3	1	1	1	1
BARIUM SALTS	4	4	4	4	1	1	1	1
BARIUM SULFIDE	3	2	3	3	1	1	1	1
BEER	3	3	1	1	1	1	1	1
BEET SUGAR LIQUORS	3	3	1	1	1	1	1	2
BENZALDEHYDE	3	3	2	3	3	1	3	3
BENZENE	3	2	3	3	3	3	1	3
BENZENESULFONIC ACID (10%)	3	3	3	3	3	3	1	2
BENZINE	4	4	4	4	1	3	1	2
BENZOIC ACID	3	3	3	3	3	3	1	3
BENZYL ALCOHOL	4	3	1	2	3	2	1	2
BENZYL CHLORIDE	3	3	2	3	3	3	1	3
BLEACH LIQUOR	4	4	4	4	3	1	1	2
BORAX	3	2	3	3	2	1	1	3
BORDEAUX MIXTURE	4	4	4	4	2	1	1	2
BORIC ACID	3	3	2	3	1	1	1	1
BRAKE FLUID (NON-PETROLEUM)	4	4	4	4	3	1	3	2
BRINE (SODIUM CHLORIDE)	3	3	1	1	1	1	1	1
BROMINE	4	4	4	4	3	3	1	3
BROMINE WATER	4	4	4	4	3	2	1	3
BUNKER OIL	4	4	4	4	1	3	1	3
BUTADIENE (MONOMER)	3	2	1	2	3	3	1	3
BUTANE	3	1	1	1	1	3	1	1
BUTANE (2,2, & 2,3-DIMETHYL)	4	4	4	4	1	3	1	2
BUTANOL (BUTYL ALCOHOL)	2	1	1	1	1	2	1	1
BUTTER - ANIMAL FAT	2	3	1	2	1	1	1	2
BUTYL BUTYRATE	4	4	4	4	3	1	1	3
BUTYL STEARATE	4	4	4	4	2	3	1	3
CALCINE LIQUORS	4	4	4	4	1	1	1	4
CALCIUM ACETATE	4	4	4	4	2	1	3	2
CALCIUM BISULFITE	3	3	2	3	2	1	2	2
CALCIUM CARBONATE	3	2	3	2	1	1	1	1
CALCIUM CHLORIDE	3	3	2	3	1	1	1	1
CALCIUM HYDROXIDE	3	3	2	3	1	1	1	1
CALCIUM HYPOCHLORITE	3	3	2	3	2	1	1	2
CALCIUM SALTS	4	4	4	4	1	1	1	1
CALCIUM SULFIDE	3	3	2	2	1	1	1	1
CALICHE LIQUORS	4	4	4	4	1	1	1	1
CANE SUGAR LIQUORS	4	2	1	1	1	1	1	1
CARBON BISULPHIDE	4	4	4	4	3	3	1	3
CARBON DIOXIDE	1	2	1	1	1	1	1	1
CARBON DISULFIDE	2	2	2	2	3	3	1	3
CARBON MONOXIDE	1	1	1	1	1	1	1	2
CARBON TETRACHLORIDE	2	3	1	3	2	3	1	3
CARBONIC ACID	3	3	1	2	2	1	1	1
CASTOR OIL	1	1	1	1	1	2	1	1
CELLUGUARD	4	4	4	4	1	1	1	1
CELLULUBE (NOW FYRQUEL)	4	4	4	4	3	1	1	3
CHINA WOOD OIL (TUNG OIL)	2	2	1	1	1	3	1	2
CHLORINATED SALT BRINE	4	4	4	4	3	3	1	3
CHLORINATED SOLVENTS	4	4	4	4	3	3	1	3
CHLORO BENZENE	3	3	2	3	3	3	1	3
CHLOROBUTADIENE	4	4	4	4	3	3	1	3
CHLOROFORM	3	2	2	1	3	3	1	3

Fluid Compatibility Chart

Appendices

CODES: 1 = Satisfactory 2 = Fair 3 = Not Recommended 4 = Insufficient Data Available

MEDIA	BODY MATERIAL				SEAL MATERIAL			
	Brass	Steel	316 S.S.	303 S.S.	Nitrile	E.P.	Fluorocarbon	Neoprene
CHLORPHENOL	4	4	4	4	3	3	1	3
COCOANUT OIL	4	4	4	4	1	3	1	3
COPPER CHLORIDE	4	4	4	4	1	1	1	2
COPPER SALTS	4	4	4	4	1	1	1	1
COPPER SULFATE	3	3	2	3	1	1	1	1
CORN OIL	2	1	1	1	1	3	1	3
COTTONSEED OIL	3	2	1	2	1	3	1	3
CREOSOLS	3	2	1	2	3	3	1	3
CREOSOTE	3	3	2	1	1	3	1	2
CRESYLIC ACID	4	2	1	2	3	3	1	3
CRUDE OIL	3	2	1	1	2	3	1	3
CUTTING OIL	4	1	1	1	1	3	1	2
DECANE	4	4	4	4	1	3	1	3
DENATURED ALCOHOL	4	4	4	4	1	1	1	1
DETERGENT, WATER SOLUTION	3	3	1	1	1	1	1	2
DIESEL FUEL	1	1	1	1	1	3	1	3
DIETHYLENE GLYCOL	3	1	1	1	1	1	1	1
DIMETHYL FORMAMIDE	4	4	1	1	2	1	3	3
DOW CHEMICAL HD50-4	4	4	4	4	4	1	3	2
DOW CORNING 200, 510, 550	4	4	4	4	2	1	1	1
DOWTHERM A.E	3	1	2	2	3	3	1	3
ETHANOL	1	3	3	3	3	1	3	1
ETHYL CHLORIDE	2	3	1	3	1	3	1	3
ETHYL HEXANOL	4	4	4	4	1	1	1	1
ETHYLENE DICHLORIDE	3	3	1	2	3	3	1	3
ETHYLENE GLYCOL	2	2	1	2	1	1	1	1
FATTY ACIDS	3	3	1	2	2	3	1	2
FREON 11	1	4	4	4	2	3	2	3
FREON 12	1	1	3	1	2	3	1	1
FREON 22	1	3	1	1	3	3	3	1
FREON 134a	1	1	1	1	2	1	4	1
FUEL OIL	3	1	1	1	1	3	1	2
GALLIC ACID	3	3	2	2	2	2	1	2
GAS, LIQUID, PROPANE (LPG)	1	3	1	1	1	3	1	2
GAS, NATURAL	2	3	1	1	1	3	1	1
GASOLINE	1	2	1	1	3	3	1	3
GELATIN	3	3	1	1	1	1	1	1
GLUCOSE	1	1	1	1	1	1	1	1
GLYCERINE (GLYCEROL)	2	1	1	1	1	1	1	1
GLYCOLS	3	2	2	2	1	1	3	1
GREEN SULFATE LIQUOR	3	3	3	3	2	1	1	2
GULF - FR FLUID (EMULSION)	4	4	4	4	1	3	1	2
GULF - FR FLUID G	4	4	4	4	1	1	1	1
GULF - FR FLUID P	4	4	4	4	3	2	2	3
HELIUM	1	1	1	1	1	1	1	1
HEPTANE	1	1	1	1	1	3	1	2
HYDRAULIC OIL (PETROLEUM BASE)	1	1	1	1	1	3	1	1
HYDRAULIC OIL (WATER BASE)	4	1	1	1	2	1	3	2
HYDRAZINE	4	3	1	1	2	1	3	2
HYDROGEN GAS	2	2	1	1	1	1	1	1
HYDROLUBE	4	4	4	4	1	1	1	2
ISO OCTANE	1	1	1	1	1	3	1	2
ISOBUTYL ALCOHOL	4	4	1	1	2	1	1	1
ISOPROPYL ALCOHOL	1	1	2	1	2	1	1	2
ISOPROPYL ETHER	1	1	1	1	2	3	3	3
JP3 AND JP4	1	1	1	1	1	3	1	3
KEROSENE	1	1	1	1	1	3	1	2
LARD, ANIMAL FAT	1	1	1	1	1	2	1	2
LINSEED OIL	3	1	1	1	1	3	1	3
LUBRICATING OIL SAE 10, 20, 30, 40, 50	1	1	1	1	1	3	1	2
MAGNESIUM SALTS	4	4	4	4	1	1	1	1
MAGNESIUM SULPHATE	3	3	2	2	1	1	1	1
MERCURY	3	3	1	1	1	1	1	1
METHANE	1	3	1	1	1	3	1	2
METHANOL	1	1	1	1	1	1	3	1
METHYL BROMIDE	4	1	1	1	2	3	1	3

Fluid Compatibility Chart

Appendices

CODES: 1 = Satisfactory 2 = Fair 3 = Not Recommended 4 = Insufficient Data Available

MEDIA	BODY MATERIAL				SEAL MATERIAL			
	Brass	Steel	316 S.S.	303 S.S.	Nitrile	E.P.	Fluorocarbon	Neoprene
METHYL CHLORIDE (DRY)	2	3	1	1	3	3	1	3
METHYL CHLORIDE (WET)	1	3	1	3	3	3	1	3
METHYL ETHER	4	4	4	4	1	3	1	3
METHYL ETHYL KETONE (MEK)	1	1	1	1	3	1	3	3
MIL-F-81912 (JP-9)	1	1	1	1	3	3	1	3
MIL-H-5606	1	1	1	1	1	3	1	2
MIL-H-6083	1	1	1	1	1	3	1	1
MIL-H-7083	1	1	1	1	1	1	2	2
MIL-H-8446 (MLO-8515)	2	1	1	1	2	3	1	1
MIL-L-2104 & 2104B	1	1	1	1	1	3	1	2
MIL-L-7808	3	2	1	1	2	3	1	3
MILK	2	1	1	1	1	1	1	1
MINERAL OILS	1	1	1	1	1	3	1	2
MLO-7277 AND MLO-7557	2	1	1	1	3	3	1	3
MOBILE HF	1	1	1	1	1	3	1	2
MONOMETHYL HYDRAZINE	4	4	4	4	2	1	4	2
NAPHTHA (COAL OR PETROLEUM)	2	1	2	2	2	3	1	3
NAPHTHALENE	2	1	2	2	3	3	1	3
NAPHTHENIC ACID	2	1	2	2	2	3	1	3
NEATSFOOT OIL	4	4	4	4	1	2	1	3
NICKEL ACETATE	3	2	1	1	2	1	3	2
NICKEL CHLORIDE	3	3	2	2	1	1	1	2
NICKEL SALTS	4	4	4	4	1	1	1	2
NICKEL SULFATE	3	3	1	1	1	1	1	1
NITROGEN	1	1	1	1	1	1	1	1
NITROUS OXIDE	2	2	2	1	1	4	4	4
OCTYL ALCOHOL	1	1	1	1	2	3	1	2
OLIVE OIL	2	1	1	1	1	2	1	2
ORTHO-DICHLOROBENZENE	2	2	2	2	3	3	1	3
OXALIC ACID	3	3	2	1	2	1	1	2
OXYGEN (200-400 DEGREES F.)	1	1	1	1	3	3	2	3
OXYGEN, COLD	1	1	1	1	2	1	1	1
OZONE	3	3	1	1	3	1	1	3
PALMITIC ACID	1	2	1	1	1	2	1	2
PARA-DICHLOROBENZENE	2	1	1	2	3	3	1	3
PARKER O LUBE	1	1	1	1	1	3	1	1
PEANUT OIL	2	1	1	1	1	3	1	3
PENTANE (2-3-METHYL, & 2-4 DIMETHYL)	2	2	2	2	1	3	1	2
PERCHLORIC ACID -2N	3	3	2	2	3	2	1	2
PERCHLOROETHYLENE	3	2	2	2	2	3	1	3
PETROLATUM	1	1	1	1	1	3	1	2
PETROLEUM OIL, BELOW 250 DEGREES F.	1	1	1	1	1	3	1	2
PHENOL	1	1	1	1	3	3	1	3
PHOSPHORIC ACID (3 MOLAR)	3	3	2	2	1	1	1	2
PHOSPHORIC ACID (CONCENTRATED)	3	3	2	2	3	1	1	3
PHOSPHOROUS TRICHLORIDE	3	3	1	1	3	1	1	3
PICRIC ACID, MOLTEN	3	3	2	2	2	2	1	2
PICRIC ACID, WATER SOLUTION	3	3	2	2	1	1	1	1
PINE OIL	2	2	1	2	1	3	1	3
PLATING SOLUTIONS (CHROME)	1	3	1	1	4	1	1	3
PLATING SOLUTIONS (OTHER)	4	1	1	1	1	1	1	3
PNEUMATIC SERVICE	1	1	1	1	1	1	1	1
POTASSIUM ACETATE	2	1	2	2	2	1	3	2
POTASSIUM CHLORIDE	3	3	1	2	1	1	1	1
POTASSIUM CYANIDE	3	2	2	2	1	1	1	1
POTASSIUM DICHROMATE	3	1	2	2	1	1	1	1
POTASSIUM HYDROXIDE (50%)	3	2	1	2	2	1	3	2
POTASSIUM NITRATE	2	1	1	1	1	1	1	1
POTASSIUM SALTS	4	4	4	4	1	1	1	1
POTASSIUM SULFATE	3	2	1	1	1	1	1	1
PRL-HIGH TEMP. HYDR. OIL	4	4	4	4	2	3	1	2
PRODUCER GAS	2	1	1	1	1	3	1	2
PROPANE	1	3	1	1	1	3	1	2
PROPYL ACETATE	3	1	1	1	3	2	3	3
PROPYL ALCOHOL	1	1	1	1	1	1	1	1
PROPYLENE	1	1	1	1	3	3	1	3

Fluid Compatibility Chart

Appendices

CODES: 1 = Satisfactory 2 = Fair 3 = Not Recommended 4 = Insufficient Data Available

MEDIA	BODY MATERIAL				SEAL MATERIAL			
	Brass	Steel	316 S.S.	303 S.S.	Nitrile	E.P.	Fluorocarbon	Neoprene
PYDRAUL 10E	3	1	1	1	3	1	3	3
PYDRAUL A-200, C SERIES	3	1	1	1	3	3	1	3
PYDRAUL, 3 SERIES	3	1	1	1	3	1	1	3
PYROGARD 42, 43, 53, 55 (PHOSPHATE ESTER)	4	4	4	4	3	1	1	3
PYROGARD D	4	4	4	4	1	3	3	2
SEA WATER (SALT WATER)	2	3	1	1	1	1	1	2
SHELL IRUS 905	4	4	4	4	1	3	1	2
SILICONE GREASES	1	1	1	1	1	1	1	1
SILVER NITRATE	3	3	1	2	2	1	1	1
SKYDROL 500, TYPE 2	3	1	1	1	3	1	3	3
SKYDROL 7000, TYPE 2	3	1	1	1	3	1	2	3
SOAP SOLUTIONS	3	3	1	1	1	1	1	2
SODIUM ACETATE	1	1	1	1	2	1	3	2
SODIUM BICARBONATE (BAKING SODA)	2	2	1	1	1	1	1	1
SODIUM BISULPHATE OR BISULPHITE	3	3	2	1	1	1	1	1
SODIUM BORATE	3	2	2	2	1	1	1	1
SODIUM CARBONATE (SODA ASH)	4	1	1	1	1	1	1	1
SODIUM CHLORIDE	3	2	2	2	1	1	1	1
SODIUM CYANIDE	3	1	1	1	1	1	4	1
SODIUM HYDROXIDE (CAUSTIC SODA, LYE)	3	2	1	2	2	1	2	2
SODIUM HYDROXIDE, 50%	3	3	1	2	2	1	2	2
SODIUM METAPHOSPHATE	2	1	2	2	1	1	1	2
SODIUM NITRATE	3	2	1	1	2	1	4	2
SODIUM PERBORATE	3	3	1	1	2	1	1	2
SODIUM PEROXIDE	3	1	2	2	2	1	1	2
SODIUM PHOSPHATES	1	3	2	1	1	1	1	2
SODIUM SALTS	4	4	4	4	1	1	1	2
SODIUM SULFATE	3	2	1	1	1	1	1	1
SODIUM SULFIDE AND SULFITE	3	3	2	3	1	1	1	1
SODIUM THIOSULFATE	3	3	1	2	2	1	1	1
SOYBEAN OIL	2	1	1	1	1	3	1	3
STANNOUS CHLORIDE (15%)	3	3	2	3	1	1	1	1
STEAM, BELOW 400 DEGREEES F.	1	3	1	1	3	1*	3	3
STODDARD SOLVENT	2	1	1	1	1	3	1	2
SUCROSE SOLUTIONS	1	1	1	1	1	1	1	2
SULFUR	2	1	1	1	3	1	1	1
SULFUR LIQUORS	1	1	1	1	2	2	1	2
SULFUR (MOLTEN)	3	3	1	1	3	3	1	3
SULFUR DIOXIDE (DRY)	3	1	1	3	3	1	3	3
SULFUR TRIOXIDE (DRY)	2	2	2	3	3	2	1	3
SUNSAFE	3	1	1	1	1	3	1	2
TANNIC ACID (10%)	1	3	2	3	1	1	1	2
TAR, BITUMINOUS	2	1	1	1	2	3	1	3
TARTARIC ACID	2	3	3	2	1	2	1	2
TERPINEOL	4	4	4	4	2	3	1	3
TERTIARY BUTYL ALCOHOL	1	1	1	1	2	2	1	2
TETRACHLOROETHANE	4	2	1	2	3	3	1	3
TETRACHLOROETHYLENE	3	2	2	4	3	3	1	3
TETRAETHYL LEAD	1	1	1	1	2	3	1	2
TETRAETHYL LEAD (BLEND)	1	1	1	1	2	3	1	3
TITANIUM TETRACHLORIDE	2	1	2	3	2	3	1	3
TOLUENE	1	1	1	1	3	3	1	3
TRANSFORMER OIL	1	1	1	1	1	3	1	2
TRANSMISSION FLUID (TYPE A)	1	1	1	1	1	3	1	2
TRICHLOROETHANE	4	2	1	4	3	3	1	3
TRICHLOROETHYLENE	3	2	2	2	3	3	1	3
TRICRESYL PHOSPHATE	4	1	2	2	3	1	2	3
TURBINE OIL #15 (MIL-L-7808A)	4	2	1	1	2	3	1	3
TURPENTINE	3	2	1	1	1	3	1	3
VARNISH	1	1	1	1	2	3	1	3
WATER	1	3	1	1	1	1	2	2
WHISKEY	1	3	1	1	1	1	1	1
WINE	1	3	1	1	1	1	1	1
WOOD OIL	4	2	1	1	1	3	1	2
XYLENE	1	2	1	1	3	3	1	3
ZINC SULFATE	3	3	2	2	1	1	1	1

Contact the division for special EP compound used on 60 Series couplings



SAFETY GUIDE FOR SELECTING AND USING QUICK ACTION COUPLINGS AND RELATED ACCESSORIES

DANGER: Failure or improper selection or improper use of quick action couplings or related accessories can cause death, personal injury and property damage. Possible consequences of failure or improper selection or improper use of quick action couplings or related accessories include but are not limited to:



- Couplings or parts thrown off at high speed.
- High velocity fluid discharge.
- Explosion or burning of the conveyed fluid.
- Contact with suddenly moving or falling objects that are to be held in position or moved by the conveyed fluid.
- Dangerously whipping hose.
- Contact with conveyed fluids that may be hot, cold, toxic, or otherwise injurious.
- Sparking or explosion while paint or flammable liquid spraying.

Before selecting or using any Parker quick action couplings or related accessories, it is important that you read and follow the following instructions.

1.1 Scope: This safety guide provides instructions for selecting and using (including installing connecting, disconnecting, and maintaining) quick action couplings and related accessories (including caps, plugs, blow guns, and two way valves). This safety guide is a supplement to and is to be used with, the specific Parker publications for the specific quick action couplings and related accessories that are being considered for use.

1.2 Fail-Safe: Quick action couplings or the hose they are attached to can fail without warning for many reasons. Design all systems and equipment in a fail-safe mode, so that failure of the quick action coupling or hose will not endanger persons or property.

1.3 Distribution: Provide a copy of this safety guide to each person that is responsible for selecting or using quick action coupling products. Do not select or use quick action couplings without thoroughly reading and understanding this safety guide as well as the specific Parker publications for the products considered or selected.

1.4 User Responsibility: Due to the wide variety of operating conditions and uses for quick action couplings, Parker and its distributors do not represent or warrant that any particular quick action coupling is suitable for any specific end use system. This safety guide does not analyze all technical parameters that must be considered in selecting a product. The user, through its own analysis and testing, is solely responsible for:

- Making the final selection of the quick action couplings.
- Assuring that the user's requirements are met and that the use presents no health or safety hazards.
- Providing all appropriate health and safety warnings on the equipment on which the quick action couplings are used.

1.5 Additional Questions: Call the appropriate Parker customer service department if you have any questions or require any additional information. For the telephone numbers of the appropriate customer service department, see the Parker publication for the product being considered or used.

2.0 QUICK ACTION COUPLING SELECTION INSTRUCTIONS

2.1 Pressure: Quick action couplings selection must be made so that the published rated pressure of the coupling is equal to or greater than the maximum system pressure. Surge pressures in the system higher than the rated pressure of the coupling will shorten the quick action coupling's life. Do not confuse burst pressure or other pressure values with rated pressure and do not use burst pressure or other pressure values for this purpose.

2.2 Fluid Compatibility: Quick action couplings selection must assure compatibility of the body and seal materials with the fluid media used. See the fluid compatibility chart in the Parker publication for the product being considered or used.

2.3 Temperature: Be certain that fluid and ambient temperatures, both steady and transient, do not exceed the limitations of the quick action couplings. Use caution and hand protection when connecting or disconnecting quick action couplings that are heated or cooled by the media they are conducting or by their environment.

2.4 Size: Transmission of power by means of pressurized liquid varies with pressure and rate of flow. The size of the quick action couplings and other components of the system must be adequate to keep pressure losses to a minimum and avoid damage due to heat generation or excessive fluid velocity.

2.5 Pressurized Connect or Disconnect: If connecting or disconnecting under pressure is a requirement, use only quick action couplings designed for that purpose. The rated operating pressure of a quick action coupling may not be the pressure at which it may be safely connected or disconnected.

2.6 Environment: Care must be taken to ensure that quick action couplings are either compatible with or protected from the environment (that is, surrounding conditions) to which they are exposed. Environmental conditions including but not limited to ultraviolet radiation, ozone, moisture, water, salt water, chemicals, and air pollutants can cause degradation and premature failure.

2.7 Locking Means: Ball locking quick action couplings can unintentionally disconnect if they are dragged over obstructions on the end of a hose or if the sleeve is bumped or moved enough to cause disconnect. Sleeves designed with flanges to provide better gripping for oily or gloved hands are especially susceptible to accidental disconnect and should not be used where these conditions exist. Sleeve lock or union (threaded) sleeve designs should be considered where there is a potential for accidental uncoupling.

2.8 Mechanical Loads: External forces can significantly reduce quick action couplings' life or cause failure. Mechanical loads which must be considered include excessive tensile or side loads, and vibration. Unusual applications may require special testing prior to quick action couplings selection.

2.9 Specifications and Standards: When selecting quick action couplings, government, industry, and Parker specifications must be reviewed and followed as applicable.

2.10 Vacuum: Not all quick action couplings are suitable or recommended for vacuum service. Quick action couplings used for vacuum applications must be selected to ensure that the quick actions couplings will withstand the vacuum and pressure of the system.

2.11 Fire Resistant Fluids: Some fire resistant fluids require seals other than the standard nitrile used in many quick action couplings.

2.12 Radiant Heat: Quick action couplings can be heated to destruction or loss of sealability without contact by such nearby items as hot manifolds or molten metal. The same heat source may then initiate a fire. This can occur despite the presence of cool air around the quick action couplings.

2.13 Welding and Brazing: Heating of plated parts, including quick action couplings and port adapters, above 450°F (232°C) such as during welding, brazing, or soldering may emit deadly gases and may cause coupling seal damage.

Appendices

3.0 QUICK ACTION COUPLING INSTALLATION INSTRUCTIONS

3.1 Pre-Installation Inspection: Before installing a quick action coupling, visually inspect it and check for correct style, body material, seal material, and catalog number. Before final installation, coupling halves should be connected and disconnected with a sample of the mating half with which they will be used.

3.2 Quick Action Coupling Halves From Other Manufacturers: If a quick action coupling assembly is made up of one Parker half and one half from another manufacturer, the lowest pressure rating of the two halves should not be exceeded.

3.3 Fitting Installation: Use a thread sealant, lubricant, or a combination of both when assembling pipe thread joints in quick action couplings. Be sure the sealant is compatible with the system fluid or gas. To avoid system contamination, use a liquid or paste type sealant rather than a tape style. Use the flats provided to hold the quick action coupling when installing fittings. Do not use pipe wrenches or a vice on other parts of the coupling to hold it when installing or removing fittings as damage or loosening of threaded joints in the coupling assembly could result. Do not apply excessive torque to taper pipe threads because cracking or splitting of the female component can result.

3.4 Caps and Plugs: Use dust caps and plugs when quick action couplings are not coupled to exclude dirt and contamination and to protect critical surfaces from damage.

3.5 Coupling Location: Locate quick action couplings where they can be reached for connect or disconnect without exposing the operator to slipping, falling, getting sprayed, or coming in contact with hot or moving parts.

3.6 Hose Whips: Use a hose whip (a short length of hose between the tool and the coupling half) instead of rigidly mounting a coupling half on hand tools or other devices. This reduces the potential for coupling damage if the tool is dropped and provides some isolation from mechanical vibration which could cause uncoupling.

4.0 QUICK ACTION COUPLING MAINTENANCE INSTRUCTIONS

4.1 Even with proper selection and installation, quick action coupling life may be significantly reduced without a continuing maintenance program. Frequency should be determined by the severity of the application and risk potential. A maintenance program must be established and followed by the user and must include the following as a minimum:

4.2 Visual Inspection of Quick Action Couplings: Any of the following conditions require immediate shut down and replacement of the quick action coupling:

- Cracked, damaged, or corroded quick action coupling parts.
- Leaks at the fitting, valve or mating seal.
- Broken coupling mounting hardware, especially breakaway clamps.

4.3 Visual Inspection All Other: The following items must be tightened, repaired or replaced as required:

- Leaking seals or port connections.
- Remove excess dirt buildup on the coupling locking means or on the interface area of either coupling half.
- Clamps, guards, and shields.
- System fluid level, fluid type and any air entrapment.

4.4 Functional Test: Operate the system at maximum operating pressure and check for possible malfunctions and freedom from leaks. Personnel must avoid potential hazardous areas while testing and using the system.

4.5 Replacement Intervals: Specific replacement intervals must be considered based on previous service life, government or industry recommendations, or when failures could result in unacceptable downtime, damage or injury risk. See instruction 1.2 above.

Additional copies of the preceding safety information can be ordered by requesting "Safety Guide For Selecting and Using Quick Action Couplings and Related Accessories," Parker Publication No. 3800-B1.0

Contact The Quick Coupling Division, Minneapolis, MN.

Appendices

Note

1. Inclusion of part numbers in this index or elsewhere in the catalog is not necessarily an indication that they are available from stock. Only items listed in the current price list are carried in stock. Parts marked as Semi-Standard, consult factory for price and delivery.

2. Catalog numbers ending in the letter W, Y, or Z are not listed in this index, as these suffixes merely designate the use of an optional seal. The item can be located in the catalog by referring to the basic number without the W, Y or Z suffix. This does not apply to SM, HP, NS, NC, FF, FS, FH, TC, and HO Series. Please see ordering information at the end of Section B.

Part No.	Page	Part No.	Page	Part No.	Page	Part No.	Page
A2C	A-15	B36E	A-29	BH6-60-STM	B-9	BST-N8M	B-55
A3C	A-15	B36G	A-29	BH6-61	B-7	C-25	B-60
A8C	A-15	B37	A-29	BH6-61-STM	B-9	C-50	B-60
A8CP	A-15	B37E	A-29	BH67E-60K	B-8	C50A01-4-4	A-25
B10-3B	A-10	B37G	A-29	BH67E-61K	B-8	C50A01-4-6	A-25
B10-3BP	A-10	B38	A-29	BH67F-60K	B-8	C50A02-4-4	A-25
B10-4B	A-10	B38-7B	A-30	BH67F-61K	B-8	C50A02-4-6	A-25
B10-5B	A-10	B38-8B	A-30	BH67G-60K	B-8	C-75	B-60
B10-5BP	A-10	B38J	A-29	BH67G-61K	B-8	CDM01-2-2Y	B-59
B12	A-10	B39	A-29	BH67J-60K	B-8	CDM01-2-4Y	B-59
B12A	A-10	B39F	A-29	BH67J-61K	B-8	CDM02-2-2Y	B-59
B12E	A-10	B39J	A-29	BH8-60	B-7	CDM02-2-4Y	B-59
B13	A-10	B3C	A-11	BH8-60-STM	B-9	CJ-251-4FP	A-40
B13A	A-10	B50-3BP	A-14	BH8-61	B-7	CJ-251-4HB	A-40
B13E	A-10	B50-5BP	A-14	BH8-61-STM	B-9	CJ-251-4MP	A-40
B14	A-10	B52	A-14	BH8CP	A-7	CJ-251-6FP	A-40
B15	A-10	B52E	A-14	BPD323Y	F-19	CJ-251-6HB	A-40
B16	A-10, A-13	B53	A-14	BPD343Y	F-19	CJ-251-6MP	A-40
B17	A-10, A-13	B53E	A-14	BPDFS341	F-26	CJ-254-4FP	A-40
B20-3B	A-13	B72	A-16	BPDFS343	F-26	CJ-254-4HB	A-40
B20-3BP	A-13	B73	A-16	BPDFS357	F-26	CJ-254-4MP	A-40
B20-4B	A-13	BG441-NBL	A-43	BPN251F	B-51	CJ-254-6FP	A-40
B20-5B	A-13	BG442-SBL	A-43	BPN252F	B-51	CJ-254-6HB	A-40
B20-5BP	A-13	BG443-NBL	A-43	BPN253F	B-51	CJ-254-6MP	A-40
B22	A-13	BG444-SBL	A-43	BPN352F	B-51	CJ304F-4	A-40
B22A	A-13	BG445-SBL	A-43	BPN353F	B-51	CJ304F-6	A-40
B22E	A-13	BH12-60L	B-8	BPV252	B-51	CJ304HB-4	A-40
B23	A-13	BH12-60N	B-8	BPV353	B-51	CJ304HB-6	A-40
B23A	A-13	BH12-61L	B-8	BST-1	B-54	CJ304M-4	A-40
B23E	A-13	BH12-61N	B-8	BST-10	B-54	CJ304M-6	A-40
B24	A-13	BH1-60	B-7	BST-12	A-40	CJ604F-4	A-40
B25	A-13	BH1-61	B-7	BST-1M	B-54	CJ604F-6	A-40
B2C	A-11	BH2016-60	B-8	BST-2	B-54	CJ604HB-4	A-40
B30-3B	A-30	BH2016-61	B-8	BST-2M	B-54	CJ604HB-6	A-40
B30-3BP	A-30	BH2020-60	B-8	BST-3	A-40	CJ604M-4	A-40
B30-4B	A-30	BH2020-61	B-8	BST-3M	B-54	CJ604M-6	A-40
B30-5B	A-30	BH2024-60	B-8	BST-4	B-54	CR-25	B-60
B30-5BP	A-30	BH2024-61	B-8	BST-4M	B-54	CRF01-4-4	A-19
B32	A-29	BH2-60	B-7	BST-6	B-54	CRF01-4-6	A-19
B32A	A-29	BH2-60-STM	B-9	BST-6M	B-54	CRF01-4-8	A-19
B32E	A-29	BH2-61	B-7	BST-8	B-54	CRF02-4-4	A-19
B33	A-29	BH2-61-STM	B-9	BST-8M	B-54	CRF02-4-6	A-19
B33A	A-29	BH2C	A-6	BST-N1	B-55	CRFHB-4-4	A-19
B33E	A-29	BH2E	A-6	BST-N10	B-55	CRFHB-4-6	A-19
B34	A-29	BH2F	A-6	BST-N10M	B-55	CRFPL-4-4	A-19
B34-5B	A-30	BH2G	A-6	BST-N12	B-55	CRFPL-4-6	A-19
B34-5BP	A-30	BH3-60	B-7	BST-N12M	B-55	CRFPL-4-8	A-19
B34-6B	A-30	BH3-61	B-7	BST-N1M	B-55	CV-1000-FOFO	E-10
B34C	A-29	BH3C	A-6	BST-N2	B-55	CV-1000-FPPF	E-11
B34F	A-29	BH3E	A-6	BST-N2M	B-55	CV-1000-MFMF	E-10
B35	A-29	BH3F	A-6	BST-N3	B-55	CV-1000-MOMS	E-10
B35C	A-29	BH4-60	B-7	BST-N3M	B-55	CV-250-FOFO	E-10
B35F	A-29	BH4-60-STM	B-9	BST-N4	B-55	CV-250-FPPF	E-11
B36	A-29	BH4-61	B-7	BST-N4M	B-55	CV-250-MFMF	E-10
B36-6B	A-30	BH4-61-STM	B-9	BST-N6	B-55	CV-250-MOMS	E-10
B36-6BP	A-30	BH5G	A-7	BST-N6M	B-55	CV-370-FOFO	E-10
B36-7B	A-30	BH6-60	B-7	BST-N8	B-55	CV-370-FPPF	E-11

* Denotes parts that are offered in brass as standard, and are also on page listed.
 ** Semi Standard, consult factory for price & delivery.



Appendices

Part No.	Page	Part No.	Page	Part No.	Page	Part No.	Page
CV-370-MFMF.....	E-10	EMA3/7/16-20UNF-2A.....	F-23	FEM-1002-16FO.....	B-28	FF-501.....	B-29
CV-370-MOMS.....	E-10	EMA3/9/16-18UNF-2A.....	F-23	FEM-1002-16FP.....	B-28	FF-501-10FO.....	B-24
CV-500-FOFO.....	E-10	EMA3/M8X1OR.....	F-23	FEM-251-4FP-NL.....	B-28	FF-501-8FP.....	B-24
CV-500-FPPF.....	E-11	EMA3VS.....	F-24	FEM-252-4FP.....	B-28	FF-501-KIT.....	B-24
CV-500-MFMF.....	E-10	EZ-251-4FP.....	A-38	FEM-371-6FP-NL.....	B-28	FF-501-KIT-E4.....	B-24
CV-500-MOMS.....	E-10	EZ-251-4HB.....	A-38	FEM-371-8FO-NL.....	B-28	FF-501-KIT-E5.....	B-24
CV-620-FOFO.....	E-10	EZ-251-4MP.....	A-38	FEM-372-6FP.....	B-28	FF-501-TOOL.....	B-24
CV-620-MFMF.....	E-10	EZ-251-4PL.....	A-38	FEM-372-8FO.....	B-28	FF-502-10FO.....	B-24
CV-620-MOMS.....	E-10	EZ-251-6FP.....	A-38	FEM-501-10BMF-NL.....	B-28	FF-502-8FP.....	B-24
CV-750-FOFO.....	E-10	EZ-251-6HB.....	A-38	FEM-501-10BMS-NL.....	B-28	FF-502-KIT.....	B-24
CV-750-FPPF.....	E-11	EZ-251-6MP.....	A-38	FEM-501-10FO-NL.....	B-28	FF-502-KIT-E4.....	B-24
CV-750-MFMF.....	E-10	EZ-251-6PL.....	A-38	FEM-501-12FO-NL.....	B-28	FF-502-KIT-E5.....	B-24
CV-750-MOMS.....	E-10	EZ304F-4T.....	A-38	FEM-501-8FP-NL.....	B-28	FF-751.....	B-29
DM-121-2FP.....	B-59	EZ304F-6T.....	A-38	FEM-502-10BMS.....	B-28	FF-751-12FO.....	B-24
DM-121-2FP.....	B-59	EZ304HB-4T.....	A-38	FEM-502-10FO.....	B-28	FF-751-12FP.....	B-24
DM-121-4FP.....	B-59	EZ304HB-6T.....	A-38	FEM-502-10BMF.....	B-28	FF-751-KIT.....	B-24
DM-121-4MP.....	B-59	EZ304M-4T.....	A-38	FEM-502-12FO.....	B-28	FF-751-KIT-E4.....	B-24
DM-122-2FP.....	B-59	EZ304M-6T.....	A-38	FEM-502-8FP.....	B-28	FF-751-KIT-E5.....	B-24
DM-122-2MP.....	B-59	EZ304PL-4T.....	A-38	FEM-621.....	B-30	FF-752-12FO.....	B-24
DM-122-4FP.....	B-59	EZ304PL-6T.....	A-38	FEM-621-12FO-NL.....	B-28	FF-752-12FP.....	B-24
DM-122-4MP.....	B-59	EZ306F-6T.....	A-38	FEM-622-12FO.....	B-28	FF-752-KIT.....	B-24
DP-50.....	B-60, B-62	EZ306F-8T.....	A-38	FEM-751.....	B-30	FF-752-KIT-E4.....	B-24
DT-1000-MFMF.....	E-6	EZ306HB-6T.....	A-38	FEM-751-12FO-NL.....	B-28	FF-752-KIT-E5.....	B-24
DT-1000-MFMO.....	E-6	EZ306M-6T.....	A-38	FEM-751-12FP-NL.....	B-28	FH-371-6FB.....	B-32
DT-1000-MOMF.....	E-6	EZ306PL-6T.....	A-38	FEM-752-12FO.....	B-28	FH-371-6FP.....	B-32
DT-1000-MOMS.....	E-7	EZ308F-12T.....	A-38	FEM-752-12FP.....	B-28	FH-371-6MP.....	B-32
DT-1000-MSMO.....	E-7	EZ308F-8T.....	A-38	FER-502.....	B-61	FH-372-6FB.....	B-32
DT-1000-MSMS.....	E-7	EZ308HB-8T.....	A-38	FER-752.....	B-61	FH-372-6FP.....	B-32
DT-1250-MFMF.....	E-6	EZ308M-8T.....	A-38	FF/FS-1001-TOOL.....	B-24, B-34	FR-1001.....	B-61
DT-1250-MFMO.....	E-6	EZ308PL-8T.....	A-38	FF/FS-251-TOOL.....	B-24, B-34	FR-1002.....	B-61
DT-1250-MOMF.....	E-6	EZ312F-12T.....	A-38	FF/FS-371-TOOL.....	B-24, B-34	FR-25.....	B-61
DT-1250-MOMS.....	E-7	EZ312F-16T.....	A-38	FF/FS-751-TOOL.....	B-24, B-34	FR-501.....	B-61, C-9
DT-1250-MSMO.....	E-7	EZ312M-12T.....	A-38	FF-1001-16FO.....	B-24	FR-502.....	B-61, C-9
DT-1250-MSMS.....	E-7	EZ-371-6FP.....	A-38	FF-1001-16FP.....	B-24	FR-751.....	B-61
DT-250-MFMO.....	E-6	EZ-371-6HB.....	A-38	FF-1001-KIT.....	B-24	FR-752.....	B-61
DT-250-MOMF.....	E-6	EZ-371-6MP.....	A-38	FF-1001-KIT-E4.....	B-24	FS-1001-16FO.....	B-34
DT-250-MOMS.....	E-6	EZ-371-6PL.....	A-38	FF-1001-KIT-E5.....	B-24	FS-1001-16FP.....	B-34
DT-370-MFMF.....	E-6	EZ-371-8FP.....	A-38	FF-1002-16FO.....	B-24	FS-1001-KIT.....	B-34
DT-370-MFMO.....	E-6	EZ-501-12FP.....	A-38	FF-1002-16FP.....	B-24	FS-1001-KIT-E5.....	B-34
DT-370-MOMF.....	E-6	EZ-501-8FP.....	A-38	FF-1002-KIT.....	B-24	FS-1002-16FO.....	B-34
DT-370-MOMS.....	E-7	EZ-501-8HB.....	A-38	FF-1002-KIT-E4.....	B-24	FS-1002-16FP.....	B-34
DT-370-MSMO.....	E-7	EZ-501-8MP.....	A-38	FF-1002-KIT-E5.....	B-24	FS-1002-KIT.....	B-34
DT-370-MSMS.....	E-7	EZ-501-8PL.....	A-38	FF-251-4FP.....	B-24	FS-1002-KIT-E5.....	B-34
DT-500-MFMF.....	E-6	EZ-751-12FP.....	A-38	FF-251-4MP.....	B-24	FS-251-4FP.....	B-34
DT-500-MFMO.....	E-6	EZ-751-12MP.....	A-38	FF-251-6FO.....	B-24	FS-251-4MP.....	B-34
DT-500-MOMF.....	E-6	EZ-751-16FP.....	A-38	FF-251-KIT.....	B-24	FS-251-6FO.....	B-34
DT-500-MOMS.....	E-7	FAS-500.....	B-22	FF-251-KIT-E4.....	B-24	FS-251-KIT.....	B-34
DT-500-MSMO.....	E-7	FC-372-6FP.....	B-29	FF-251-KIT-E5.....	B-24	FS-251-KIT-E5.....	B-34
DT-500-MSMS.....	E-7	FC-372-8FO.....	B-29	FF-252-4FP.....	B-24	FS-252-4FP.....	B-34
DT-620-MFMF.....	E-6	FC-372-8FP.....	B-29	FF-252-4MP.....	B-24	FS-252-4MP.....	B-34
DT-620-MFMO.....	E-6	FC-502-10FO.....	B-29	FF-252-6FO.....	B-24	FS-252-6FO.....	B-34
DT-620-MOMF.....	E-6	FC-502-8FP.....	B-29	FF-252-KIT.....	B-24	FS-252-KIT.....	B-34
DT-620-MOMS.....	E-7	FC-752-12FO.....	B-29	FF-252-KIT-E4.....	B-24	FS-252-KIT-E5.....	B-34
DT-620-MSMO.....	E-7	FC-752-12FP.....	B-29	FF-252-KIT-E5.....	B-24	FS-371-6FP.....	B-34
DT-620-MSMS.....	E-7	FE-501.....	B-30	FF-371.....	B-29	FS-371-8FO.....	B-34
DT-750-MFMF.....	E-6	FE-501-12FO.....	B-26	FF-371-6FB.....	B-24	FS-371-KIT.....	B-34
DT-750-MFMO.....	E-6	FE-501-8FP.....	B-26	FF-371-6FP.....	B-24	FS-371-KIT-E5.....	B-34
DT-750-MOMF.....	E-6	FE-502-12FO.....	B-26	FF-371-8FB.....	B-24	FS-372-6FP.....	B-34
DT-750-MOMS.....	E-7	FE-502-8FP.....	B-26	FF-371-8FO.....	B-24	FS-372-8FO.....	B-34
DT-750-MSMO.....	E-7	FE-621-12FO.....	B-26	FF-371-8FP.....	B-24	FS-372-KIT.....	B-34
DT-750-MSMS.....	E-7	FE-622-12FO.....	B-26	FF-371-KIT.....	B-24	FS-372-KIT-E5.....	B-34
EAS-500.....	B-22	FEC-1002-16FO.....	B-30	FF-371-KIT-E4.....	B-24	FS-501-10FO.....	B-34
EMA3/1/4ED.....	F-23	FEC-1002-16FP.....	B-30	FF-371-KIT-E5.....	B-24	FS-501-8FP.....	B-34
EMA3/1/4NPT.....	F-23	FEC-502-10FO.....	B-30	FF-372-6FB.....	B-24	FS-501-KIT.....	B-34
EMA3/1/4NPT71.....	F-23	FEC-502-12FO.....	B-30	FF-372-6FP.....	B-24	FS-501-KIT-E5.....	B-34
EMA3/1/8ED.....	F-23	FEC-502-8FP.....	B-30	FF-372-8FB.....	B-24	FS-501-TOOL.....	B-34
EMA3/1/8NPT.....	F-23	FEC-622-12FO.....	B-30	FF-372-8FO.....	B-24	FS-502-10FO.....	B-34
EMA3/10X1ED.....	F-23	FEC-752-12FO.....	B-30	FF-372-8FP.....	B-24	FS-502-8FP.....	B-34
EMA3/12X1.5ED.....	F-23	FEM-1001.....	B-30	FF-372-KIT.....	B-24	FS-502-KIT.....	B-34
EMA3/14X1.5ED.....	F-23	FEM-1001-16FO-NL.....	B-28	FF-372-KIT-E4.....	B-24	FS-502-KIT-E5.....	B-34
EMA3/3/8ED.....	F-23	FEM-1001-16FP-NL.....	B-28	FF-372-KIT-E5.....	B-24	FS-751-12FO.....	B-34

Appendices

Part No.	Page	Part No.	Page	Part No.	Page	Part No.	Page
FS-751-12FP	B-34	H3E-F	A-6	HF-124-4FP	A-22	HF406HB-6	A-24
FS-751-KIT	B-34	H3F	A-6	HF-124-4MP	A-22	HF406HB-8	A-24
FS-751-KIT-E5	B-34	H3F-G	A-6, A-11	HF-251-4FP	A-23	HF406M-4	A-24
FS-752-12FO	B-34	H3G	A-6	HF-251-4FP-S	A-24	HF406M-6	A-24
FS-752-12FP	B-34	H3G-F	A-6	HF-251-4HB	A-23	HF406M-8	A-24
FS-752-KIT	B-34	H3G-J	A-6	HF-251-4HB-S	A-24	HF406PL-6	A-24
FS-752-KIT-E5	B-34	H4-62	B-7	HF-251-4MP	A-23	HF406PL-8	A-24
H00E	A-6	H4-62-T10	B-7	HF-251-4MP-S	A-24	HF-501-8FP	A-23
H0C	A-6	H4-63	B-7	HF-251-4PL	A-23	HF-501-8MP	A-23
H0E	A-6	H4-63-T10	B-7	HF-251-4PL-S	A-24	HF702F-2	A-22
H0F	A-6	H4-65	B-60	HF-251-6FP	A-23	HF702F-4	A-22
H12-62L	B-8	H4-65M	B-60	HF-251-6FP-S	A-24	HF702M-2	A-22
H12-62N	B-8	H4-66	B-60	HF-251-6HB	A-23	HF702M-4	A-22
H12-62-T20	B-8	H4-66M	B-60	HF-251-6HB-S	A-24	HO-251-4FP	B-57
H12-62-T24	B-8	H4EP	A-7	HF-251-6MP	A-23	HO-252-4FP	B-57
H12-63L	B-8	H4F	A-7, A-11	HF-251-6MP-S	A-24	HO-371-6FP	B-57
H12-63N	B-8	H4FP	A-7, A-11	HF-251-6PL	A-23	HO-372-6FP	B-57
H12-63-T20	B-8	H5E	A-7	HF-251-6PL-S	A-24	HO-501-8FP	B-57
H12-63-T24	B-8	H5EP	A-7	HF302F-2	A-22	HO-502-8FP	B-57
H12-65	B-60	H5F	A-7	HF302F-4	A-22	HP-1001-16FO	B-15
H12-66	B-60	H5F-G	A-7, A-11	HF302M-2	A-22	HP-1001-16FP	B-15
H1-62	B-7	H5FP	A-7, A-11	HF302M-4	A-22	HP-1002-16FO	B-15
H1-62-T4	B-7	H5G	A-7	HF304F-4	A-23	HP-1002-16FP	B-15
H1-63	B-7	H5G-F	A-7	HF304F-6	A-23	HP-1501-24FO	B-15
H1-63-T4	B-7	H5G-J	A-7	HF304HB-4	A-23	HP-1501-24FP	B-15
H1-65	B-60	H6-62	B-7	HF304HB-6	A-23	HP-1502-24FO	B-15
H1-65M	B-60	H6-62-T12	B-7	HF304M-4	A-23	HP-1502-24FP	B-15
H1-66	B-60	H6-63	B-7	HF304M-6	A-23	HPC-100	B-15, B-61
H1-66M	B-60	H6-63-T12	B-7	HF304PL-4	A-23	HPC-150	B-15, B-61
H1C	A-6	H6-65	B-60	HF304PL-6	A-23	HPP-100	B-15, B-61
H1E	A-6	H6-65M	B-60	HF306F-4	A-23	HPP-150	B-15, B-61
H1F	A-6	H6-66	B-60	HF306F-6	A-23	KEY-BK	B-64
H2016-62	B-8	H6-66M	B-60	HF306F-8	A-23	KEY-BU	B-64
H2016-63	B-8	H67A-28	B-8	HF306HB-6	A-23	KEY-CL	B-64
H2020-62	B-8	H67C-28	B-8	HF306HB-8	A-23	KEY-GR	B-64
H2020-63	B-8	H67E-62K	B-8	HF306M-4	A-23	KEY-NI	B-64
H2024-62	B-8	H67E-63K	B-8	HF306M-6	A-23	KEY-RD	B-64
H2024-63	B-8	H67F-62K	B-8	HF306M-8	A-23	L2C	A-16
H20P-65	B-60	H67F-63K	B-8	HF306PL-6	A-23	L3C	A-16
H20P-66	B-60	H67G-62K	B-8	HF306PL-8	A-23	MAV1/4NPT-MA3	F-24
H2-62	B-7	H67G-63K	B-8	HF-371-4FP	A-23	MAV1/4NPT-MA3-KM	F-24
H2-62-T6	B-7	H67J-62K	B-8	HF-371-4FP-S	A-24	MAVMD1/4NPT-MA3	F-24
H2-63	B-7	H67J-63K	B-8	HF-371-4MP	A-23	NDM01-2-2Y	B-59
H2-63-T6	B-7	H68E-67K	B-9	HF-371-4MP-S	A-24	NDM01-2-4Y	B-59
H2-65	B-60	H69E-67K	B-9	HF-371-6FP	A-23	NDM02-2-2Y	B-59
H2-65M	B-60	H6E	A-7	HF-371-6FP-S	A-24	NDM02-2-4Y	B-59
H2-66	B-60	H6EP	A-7	HF-371-6HB	A-23	NR-100	B-61
H2-66M	B-60	H6FP	A-7	HF-371-6HB-S	A-24	NR-37	B-61
H2C	A-6	H8-62	B-7	HF-371-6MP	A-23	NR-50	B-61
H2C-E	A-6	H8-62-T16	B-7	HF-371-6MP-S	A-24	NR-75	B-61
H2C-PS	D-26	H8-63	B-7	HF-371-6PL	A-23	NRF01-4-4-S	A-20
H2E	A-6	H8-63-T16	B-7	HF-371-6PL-S	A-24	NRF01-4-6-S	A-20
H2E-F	A-6	H8-65	B-60	HF-371-8FP	A-23	NRF02-4-4-S	A-20
H2F	A-6	H8-65M	B-60	HF-371-8FP-S	A-24	NRF02-4-6-S	A-20
H2F-G	A-6, A-11	H8-66	B-60	HF-371-8HB	A-23	NRFHB-4-4-S	A-20
H2G	A-6	H8-66M	B-60	HF-371-8HB-S	A-24	NRFHB-4-6-S	A-20
H2G-F	A-6	H8C	A-7	HF-371-8MP	A-23	NRFPL-4-4-S	A-20
H2G-J	A-6	H8C-D	A-7	HF-371-8MP-S	A-24	NRFPL-4-6-S	A-20
H3-62	B-7	H8CP	A-7	HF-371-8PL	A-23	NS-1001-16FB	B-21
H3-62-T8	B-7	H9C	A-7	HF-371-8PL-S	A-24	NS-1001-16FO	B-21
H3-63	B-7	H9CP	A-7	HF404F-4	A-24	NS-1001-16FP	B-21
H3-63-T8	B-7	HA-251-4FP	A-25	HF404F-6	A-24	NS-1002-16FB	B-21
H3-65	B-60	HA-251-4MP	A-25	HF404HB-4	A-24	NS-1002-16FO	B-21
H3-65M	B-60	HA-251-6FP	A-25	HF404HB-6	A-24	NS-1002-16FP	B-21
H3-66	B-60	HA-251-6MP	A-25	HF404M-4	A-24	NS-371-6FB	B-21
H3-66M	B-60	HF-121-2FP	A-22	HF404M-6	A-24	NS-371-6FP	B-21
H3-68	B-9	HF-121-2MP	A-22	HF404PL-4	A-24	NS-371-8FO	B-21
H3-69	B-9	HF-121-4FP	A-22	HF404PL-6	A-24	NS-372-6FB	B-21
H3C	A-6	HF-121-4MP	A-22	HF406F-4	A-24	NS-372-6FP	B-21
H3C-E	A-6	HF-124-2FP	A-22	HF406F-6	A-24	NS-372-8FO	B-21
H3E	A-6	HF-124-2MP	A-22	HF406F-8	A-24	NS-501-10FO	B-21

Appendices

Part No.	Page	Part No.	Page	Part No.	Page	Part No.	Page
NS-501-8FB	B-21	PC224AV	B-49	PD363	F-19	PN250-55	B-52
NS-501-8FP	B-21	PC224AV-BP	B-49	PD365	F-20	PN251	B-51
NS-502-10FO	B-21	PC224-BP	B-49	PD366	F-20	PN251-25	B-52
NS-502-8FB	B-21	PC225	B-49	PD367C	F-19	PN251-40	B-52
NS-502-8FP	B-21	PC225AV	B-49	PD36BTL	F-20	PN251-55	B-52
NS-751-12FB	B-21	PC226	B-49	PD36BTX	F-20	PN251-70	B-52
NS-751-12FO	B-21	PC226AV	B-49	PD386	F-20	PN251-85	B-52
NS-751-12FP	B-21	PC226AV-BP	B-49	PD38BTL	F-20	PN251F	B-51
NS-752-12FB	B-21	PC226-BP	B-49	PD38BTU	F-20	PN251S	B-51
NS-752-12FO	B-21	PC306	B-49	PD38BTX	F-20	PN252	B-51
NS-752-12FP	B-21	PC306-BP	B-49	PD6-285	F-21	PN252-25	B-52
P200-9A	B-50	PC306V	B-49	PDEMA3TA*	F-14, F-16	PN252-40	B-52
P200-9AY	B-50	PC306V-BP	B-49	PDFEMA*	F-10	PN252-55	B-52
P201-01A	B-50	PC308	B-49	PDFEMA-0004	F-17	PN252-70	B-52
P208-01A	B-50	PC308-BP	B-49	PDFEMA-0216	F-17	PN252-85	B-52
P-25	B-60	PC308V	B-49	PDFEMA-0480	F-17	PN252F	B-51
P300-11S	B-50	PC308V-BP	B-49	PDFEMA-7160	F-17	PN252S	B-51
P300-6	B-50	PC316	B-50	PDFPD*	F-10	PN253	B-51
P300-9A	B-50	PC316-BP	B-50	PDFPD-0004	F-17	PN253F	B-51
P300-9AY	B-50	PC316V	B-50	PDFPD-0216	F-17	PN253S	B-51
P301-01A	B-50	PC316V-BP	B-50	PDFPD-0480	F-17	PN351-25	B-52
P308-01A	B-50	PC318	B-50	PDFPD-7160	F-17	PN351-40	B-52
P308-01A-HF	B-50	PC318-BP	B-50	PDFPDP*	F-10	PN351-55	B-52
P410B	A-44	PC318V	B-50	PDFPDP-0004	F-17	PN351-70	B-52
P415B	A-44	PC318V-BP	B-50	PDFPDP-0216	F-17	PN351-85	B-52
P420B	A-44	PC326	B-49	PDFPDP-0480	F-17	PN352	B-51
P-50	B-60	PC326-BP	B-49	PDFPDP-7160	F-17	PN352-25	B-52
P500-9A	B-50	PC326V	B-49	PDFS242	F-26	PN352-40	B-52
P-75	B-60	PC326V-BP	B-49	PDFS-PROBE	F-26	PN352-55	B-52
PBH-251-4FP	A-34	PC328	B-49	PDFS-TEST	F-26	PN352-70	B-52
PBH-251-4MP	A-34	PC328-BP	B-49	PDFS-TEST-P	F-26	PN352-85	B-52
PBH-251-6FP	A-34	PC328V	B-49	PDH-19	F-5, F-9, F-15	PN352F	B-51
PBH-251-6MP	A-34	PC328V-BP	B-49	PDP242	F-21	PN352S	B-51
PBH-371-4FP	A-34	PC500	B-50	PDP288	F-9, F-15, F-25	PN353	B-51
PBH-371-4MP	A-34	PC504	B-49	PDP323	F-22	PN353-25	B-52
PBH-371-6FP	A-34	PC504-BP	B-49	PDP341	F-22	PN353-40	B-52
PBH-371-6MP	A-34	PC506	B-49	PDP343	F-22	PN353-55	B-52
PBH-371-8FP	A-34	PC506-BP	B-49	PDP34BTL	F-22	PN353-70	B-52
PBS-251-4FP	A-36	PC514	B-50	PDP34BTX	F-22	PN353-85	B-52
PBS-251-4MP	A-36	PC514-BP	B-50	PDP361	F-22	PN353F	B-51
PBS-251-6FP	A-36	PC516	B-50	PDP36BTL	F-22	PN353S	B-51
PBS-251-6MP	A-36	PC516-BP	B-50	PDP36BTX	F-22	PN354	B-51
PBS-371-6FP	A-36	PC524	B-49	PDPTA*	F-14, F-16	PN553	B-51
PBS-371-6MP	A-36	PC524-BP	B-49	PDS1*	F-10	PN554	B-51
PBS-371-8FP	A-36	PC526	B-49	PDS2*	F-10	PN556	B-51
PBS-371-8MP	A-36	PC526-BP	B-49	PDSM35*	F-16	PR-25	B-60
PBS-501-12FP	A-36	PD222	F-19	PDSM45*	F-16	PROBEHOLDER	F-26
PBS-501-6FP	A-36	PD240	F-5, F-19	PDTA*	F-14, F-16	PS1210102-12-12	D-6
PBS-501-8FP	A-36	PD242	F-19	PDTEMA3S*	F-14, F-16	PS1210103-12-12	D-6
PBS-501-8MP	A-36	PD243	F-19	PER-251-4FP	A-34	PS1210106-12-12	D-6
PC204	B-49	PD260	F-19	PER-251-4MP	A-34	PS1210110-12-12	D-7
PC204AV	B-49	PD288	F-9, F-15, F-25	PER-251-6FP	A-34	PS12101JM-12-12	D-7
PC204AV-BP	B-49	PD3107	F-19	PER-251-6MP	A-34	PS1210202-12-12	D-7
PC204-BP	B-49	PD310BTL	F-20	PES-251-4FP	A-36	PS1210203-12-12	D-8
PC205	B-49	PD3127	F-19	PES-251-4MP	A-36	PS1210206-12-12	D-8
PC205AV	B-49	PD312BTX	F-20	PES-251-6FP	A-36	PS1210210-12-12	D-8
PC206	B-49	PD3147	F-19	PES-251-6MP	A-36	PS12102JM-12-12	D-8
PC206AV	B-49	PD322	F-19	PF-1001-16FP	C-9	PS1210302-12-12	D-9
PC206AV-BP	B-49	PD323	F-19	PF-1002-16FP	C-9	PS1210303-12-12	D-9
PC206-BP	B-49	PD331	F-19	PF-1002-32MB	C-9	PS1210306-12-12	D-9
PC214	B-50	PD341	F-19	PF-1002-32MP	C-9	PS1210310-12-12	D-10
PC214AV	B-50	PD342	F-19	PF-2001-32FP	C-9	PS12103JM-12-12	D-10
PC214AV-BP	B-50	PD343	F-19	PF-2002-32FP	C-9	PS1210502-12-12	D-10
PC214-BP	B-50	PD345	F-20	PF-501-8FP	C-9	PS1210503-12-12	D-11
PC215	B-50	PD346	F-20	PF-502-8FP	C-9	PS1210506-12-12	D-11
PC215AV	B-50	PD34BTL	F-20	PFR-1002	C-9	PS1210510-12-12	D-11
PC216	B-50	PD34BTX	F-20	PFR-1002-NS	C-9	PS12105JM-12-12	D-11
PC216AV	B-50	PD351	F-19	PL-25	B-60	PS1211002-12-12	D-12
PC216AV-BP	B-50	PD355	F-20	PN250	B-51	PS1211003-12-12	D-12
PC216-BP	B-50	PD357	F-19	PN250-25	B-52	PS1211006-12-12	D-12
PC224	B-49	PD361	F-19	PN250-40	B-52	PS1211010-12-12	D-12



Appendices

Part No.	Page	Part No.	Page	Part No.	Page	Part No.	Page
PS12110JM-12-12.....	D-13	PS16105JM-16-16.....	D-11	PS2490203-20-20.....	D-17	PS490310-4-4.....	D-20
PS121JM02-12-12.....	D-13	PS1611002-16-16.....	D-12	PS2490203-24-24.....	D-17	PS4903JM-4-4.....	D-21
PS121JM03-12-12.....	D-13	PS1611003-16-16.....	D-12	PS2490210-20-20.....	D-18	PS490502-4-4.....	D-21
PS121JM06-12-12.....	D-13	PS1611006-16-16.....	D-12	PS2490210-24-24.....	D-18	PS490503-4-4.....	D-21
PS121JM10-12-12.....	D14	PS1611010-16-16.....	D-12	PS2490302-20-20.....	D-19	PS490505-4-4.....	D-21
PS121JMJM-12-12.....	D14	PS16110JM-16-16.....	D-13	PS2490302-24-24.....	D-19	PS490506-4-4.....	D-22
PS1290102-12-12.....	D-15	PS161JM02-16-16.....	D-13	PS2490303-20-20.....	D-19	PS490507-4-4.....	D-22
PS1290103-12-12.....	D-15	PS161JM03-16-16.....	D-13	PS2490303-24-24.....	D-19	PS490510-4-4.....	D-22
PS1290105-12-12.....	D-16	PS161JM06-16-16.....	D-13	PS2491010-20-20.....	D-24	PS4905JM-4-4.....	D-22
PS1290106-12-12.....	D-16	PS161JM10-16-16.....	D14	PS2491010-24-24.....	D-24	PS491002-4-4.....	D-23
PS1290107-12-12.....	D-16	PS161JMJM-16-16.....	D14	PS3210202-32-32.....	D-7	PS491003-4-4.....	D-23
PS1290110-12-12.....	D-16	PS1690102-16-16.....	D-15	PS3210203-32-32.....	D-8	PS491005-4-4.....	D-23
PS12901JM-12-12.....	D-17	PS1690103-16-16.....	D-15	PS3210302-32-32.....	D-9	PS491006-4-4.....	D-23
PS1290202-12-12.....	D-17	PS1690105-16-16.....	D-16	PS3210303-32-32.....	D-9	PS491007-4-4.....	D-23
PS1290203-12-12.....	D-17	PS1690106-16-16.....	D-16	PS3210310-32-32.....	D-10	PS491010-4-4.....	D-24
PS1290205-12-12.....	D-18	PS1690107-16-16.....	D-16	PS3211010-32-32.....	D-12	PS4910JM-4-4.....	D-24
PS1290206-12-12.....	D-18	PS1690110-16-16.....	D-16	PS3290202-32-32.....	D-17	PS49JM02-4-4.....	D-24
PS1290207-12-12.....	D-18	PS16901JM-16-16.....	D-17	PS3290203-32-32.....	D-17	PS49JM03-4-4.....	D-24
PS1290210-12-12.....	D-18	PS1690202-16-16.....	D-17	PS3290210-32-32.....	D-18	PS49JM05-4-4.....	D-25
PS12902JM-12-12.....	D-19	PS1690203-16-16.....	D-17	PS3290302-32-32.....	D-19	PS49JM06-4-4.....	D-25
PS1290302-12-12.....	D-19	PS1690205-16-16.....	D-18	PS3290303-32-32.....	D-19	PS49JM07-4-4.....	D-25
PS1290303-12-12.....	D-19	PS1690206-16-16.....	D-18	PS3291010-32-32.....	D-24	PS49JM10-4-4.....	D-25
PS1290305-12-12.....	D-20	PS1690207-16-16.....	D-18	PS410102-4-4.....	D-6	PS49JMJM-4-4.....	D-25
PS1290306-12-12.....	D-20	PS1690210-16-16.....	D-18	PS410103-4-4.....	D-6	PS4A-RPR.....	D-26
PS1290307-12-12.....	D-20	PS16902JM-16-16.....	D-19	PS410106-4-4.....	D-6	PS4-RPR.....	D-26
PS1290310-12-12.....	D-20	PS1690302-16-16.....	D-19	PS410110-4-4.....	D-7	PS4W-RPR.....	D-26
PS12903JM-12-12.....	D-21	PS1690303-16-16.....	D-19	PS4101JM-4-4.....	D-7	PS4Y-RPR.....	D-26
PS1290502-12-12.....	D-21	PS1690305-16-16.....	D-20	PS410202-4-4.....	D-7	PS610102-6-6.....	D-6
PS1290503-12-12.....	D-21	PS1690306-16-16.....	D-20	PS410203-4-4.....	D-8	PS610103-6-6.....	D-6
PS1290505-12-12.....	D-21	PS1690307-16-16.....	D-20	PS410206-4-4.....	D-8	PS610106-6-6.....	D-6
PS1290506-12-12.....	D-22	PS1690310-16-16.....	D-20	PS410210-4-4.....	D-8	PS610110-6-6.....	D-7
PS1290507-12-12.....	D-22	PS16903JM-16-16.....	D-21	PS4102JM-4-4.....	D-8	PS6101JM-6-6.....	D-7
PS1290510-12-12.....	D-22	PS1690502-16-16.....	D-21	PS410302-4-4.....	D-9	PS610202-6-6.....	D-7
PS12905JM-12-12.....	D-22	PS1690503-16-16.....	D-21	PS410303-4-4.....	D-9	PS610203-6-6.....	D-8
PS1291002-12-12.....	D-23	PS1690505-16-16.....	D-21	PS410306-4-4.....	D-9	PS610206-6-6.....	D-8
PS1291003-12-12.....	D-23	PS1690506-16-16.....	D-22	PS410310-4-4.....	D-10	PS610210-6-6.....	D-8
PS1291005-12-12.....	D-23	PS1690507-16-16.....	D-22	PS4103JM-4-4.....	D-10	PS6102JM-6-6.....	D-8
PS1291006-12-12.....	D-23	PS1690510-16-16.....	D-22	PS410502-4-4.....	D-10	PS610302-6-6.....	D-9
PS1291007-12-12.....	D-23	PS16905JM-16-16.....	D-22	PS410503-4-4.....	D-11	PS610303-6-6.....	D-9
PS1291010-12-12.....	D-24	PS1691002-16-16.....	D-23	PS410506-4-4.....	D-11	PS610306-6-6.....	D-9
PS12910JM-12-12.....	D-24	PS1691003-16-16.....	D-23	PS410510-4-4.....	D-11	PS610310-6-6.....	D-10
PS129JM02-12-12.....	D-24	PS1691005-16-16.....	D-23	PS4105JM-4-4.....	D-11	PS6103JM-6-6.....	D-10
PS129JM03-12-12.....	D-24	PS1691006-16-16.....	D-23	PS411002-4-4.....	D-12	PS610502-6-6.....	D-10
PS129JM05-12-12.....	D-25	PS1691007-16-16.....	D-23	PS411003-4-4.....	D-12	PS610503-6-6.....	D-11
PS129JM06-12-12.....	D-25	PS1691010-16-16.....	D-24	PS411006-4-4.....	D-12	PS610506-6-6.....	D-11
PS129JM07-12-12.....	D-25	PS16910JM-16-16.....	D-24	PS411010-4-4.....	D-12	PS610510-6-6.....	D-11
PS129JM10-12-12.....	D-25	PS169JM02-16-16.....	D-24	PS4110JM-4-4.....	D-13	PS6105JM-6-6.....	D-11
PS129JMJM-12-12.....	D-25	PS169JM03-16-16.....	D-24	PS41JM02-4-4.....	D-13	PS611002-6-6.....	D-12
PS12A-RPR.....	D-26	PS169JM05-16-16.....	D-25	PS41JM03-4-4.....	D-13	PS611003-6-6.....	D-12
PS12-RPR.....	D-26	PS169JM06-16-16.....	D-25	PS41JM06-4-4.....	D-13	PS611006-6-6.....	D-12
PS12W-RPR.....	D-26	PS169JM07-16-16.....	D-25	PS41JM10-4-4.....	D14	PS611010-6-6.....	D-12
PS12Y-RPR.....	D-26	PS169JM10-16-16.....	D-25	PS41JMJM-4-4.....	D14	PS6110JM-6-6.....	D-13
PS1610102-16-16.....	D-6	PS169JMJM-16-16.....	D-25	PS490102-4-4.....	D-15	PS61JM02-6-6.....	D-13
PS1610103-16-16.....	D-6	PS16A-RPR.....	D-26	PS490103-4-4.....	D-15	PS61JM03-6-6.....	D-13
PS1610106-16-16.....	D-6	PS16-RPR.....	D-26	PS490105-4-4.....	D-16	PS61JM06-6-6.....	D-13
PS1610110-16-16.....	D-7	PS16W-RPR.....	D-26	PS490106-4-4.....	D-16	PS61JM10-6-6.....	D14
PS16101JM-16-16.....	D-7	PS16Y-RPR.....	D-26	PS490107-4-4.....	D-16	PS61JMJM-6-6.....	D14
PS1610202-16-16.....	D-7	PS2410202-20-20.....	D-7	PS490110-4-4.....	D-16	PS690102-6-6.....	D-15
PS1610203-16-16.....	D-8	PS2410202-24-24.....	D-7	PS4901JM-4-4.....	D-17	PS690103-6-6.....	D-15
PS1610206-16-16.....	D-8	PS2410203-20-20.....	D-8	PS490202-4-4.....	D-17	PS690105-6-6.....	D-16
PS1610210-16-16.....	D-8	PS2410203-24-24.....	D-8	PS490203-4-4.....	D-17	PS690106-6-6.....	D-16
PS16102JM-16-16.....	D-8	PS2410302-20-20.....	D-9	PS490205-4-4.....	D-18	PS690107-6-6.....	D-16
PS1610302-16-16.....	D-9	PS2410302-24-24.....	D-9	PS490206-4-4.....	D-18	PS690110-6-6.....	D-16
PS1610303-16-16.....	D-9	PS2410303-20-20.....	D-9	PS490207-4-4.....	D-18	PS6901JM-6-6.....	D-17
PS1610306-16-16.....	D-9	PS2410303-24-24.....	D-9	PS490210-4-4.....	D-18	PS690202-6-6.....	D-17
PS1610310-16-16.....	D-10	PS2410310-20-20.....	D-10	PS4902JM-4-4.....	D-19	PS690203-6-6.....	D-17
PS16103JM-16-16.....	D-10	PS2410310-24-24.....	D-10	PS490302-4-4.....	D-19	PS690205-6-6.....	D-18
PS1610502-16-16.....	D-10	PS2411010-20-20.....	D-12	PS490303-4-4.....	D-19	PS690206-6-6.....	D-18
PS1610503-16-16.....	D-11	PS2411010-24-24.....	D-12	PS490305-4-4.....	D-20	PS690207-6-6.....	D-18
PS1610506-16-16.....	D-11	PS2490202-20-20.....	D-17	PS490306-4-4.....	D-20	PS690210-6-6.....	D-18
PS1610510-16-16.....	D-11	PS2490202-24-24.....	D-17	PS490307-4-4.....	D-20	PS6902JM-6-6.....	D-19



Appendices

Part No.	Page	Part No.	Page	Part No.	Page	Part No.	Page
PS690302-6-6	D-19	PS890107-8-8	D-16	RF-371-6HB	A-19	S2301-12-12	D-31
PS690303-6-6	D-19	PS890110-8-8	D-16	RF-371-6MP	A-19	S2301-4-4	D-31
PS690305-6-6	D-20	PS8901JM-8-8	D-17	RF-371-6PL	A-19	S2301-6-6	D-31
PS690306-6-6	D-20	PS890202-8-8	D-17	RF-371-8FP	A-19	S2301-8-8	D-31
PS690307-6-6	D-20	PS890203-8-8	D-17	RF-371-8HB	A-19	S2302-12-12	D-31
PS690310-6-6	D-20	PS890205-8-8	D-18	RF-371-8MP	A-19	S2302-4-4	D-31
PS6903JM-6-6	D-21	PS890206-8-8	D-18	RF-371-8PL	A-19	S2302-6-6	D-31
PS690502-6-6	D-21	PS890207-8-8	D-18	RF-374-6FP	A-20	S2302-8-8	D-31
PS690503-6-6	D-21	PS890210-8-8	D-18	RF-374-6HB	A-20	S2303-10-10	D-31
PS690505-6-6	D-21	PS8902JM-8-8	D-19	RF-374-6MP	A-20	S2303-12-12	D-31
PS690506-6-6	D-22	PS890302-8-8	D-19	RF-374-6PL	A-20	S2303-16-16	D-31
PS690507-6-6	D-22	PS890303-10-10	D-19	RF-374-8FP	A-20	S2303-4-4	D-31
PS690510-6-6	D-22	PS890303-8-8	D-19	RF-374-8HB	A-20	S2303-6-6	D-31
PS6905JM-6-6	D-22	PS890305-8-8	D-20	RF-374-8MP	A-20	S2303-8-8	D-31
PS691002-6-6	D-23	PS890306-8-8	D-20	RF-374-8PL	A-20	S2307-12-12	D-31
PS691003-6-6	D-23	PS890307-8-8	D-20	RK-12E	D-33	S2307-4-4	D-31
PS691005-6-6	D-23	PS890310-8-8	D-20	RK-12N	D-33	S2307-6-6	D-31
PS691006-6-6	D-23	PS8903JM-10-10	D-21	RK-12V	D-33	S2307-8-8	D-31
PS691007-6-6	D-23	PS8903JM-8-8	D-21	RK-16E	D-33	S2310-12-12	D-31
PS691010-6-6	D-24	PS890502-8-8	D-21	RK-16N	D-33	S2310-6-6	D-31
PS6910JM-6-6	D-24	PS890503-10-10	D-21	RK-16V	D-33	S2310-8-8	D-31
PS69JM02-6-6	D-24	PS890503-8-8	D-21	RK-4/6E	D-33	S2501-12-12	D-32
PS69JM03-6-6	D-24	PS890505-8-8	D-21	RK-4/6N	D-33	S2501-6-6	D-32
PS69JM05-6-6	D-25	PS890506-8-8	D-22	RK-4/6V	D-33	S2501-8-8	D-32
PS69JM06-6-6	D-25	PS890507-8-8	D-22	RK-8E	D-33	S2502-12-12	D-32
PS69JM07-6-6	D-25	PS890510-8-8	D-22	RK-8N	D-33	S2502-6-6	D-32
PS69JM10-6-6	D-25	PS8905JM-10-10	D-22	RK-8V	D-33	S2502-8-8	D-32
PS69JMJM-6-6	D-25	PS8905JM-8-8	D-22	S2101-12-12	D-29	S2503-10-10	D-32
PS6A-RPR	D-26	PS891002-8-8	D-23	S2101-4-4	D-29	S2503-12-12	D-32
PS6-RPR	D-26	PS891003-8-8	D-23	S2101-6-6	D-29	S2503-16-16	D-32
PS6W-RPR	D-26	PS891005-8-8	D-23	S2101-8-8	D-29	S2503-6-6	D-32
PS6Y-RPR	D-26	PS891006-8-8	D-23	S2102-12-12	D-29	S2503-8-8	D-32
PS810102-8-8	D-6	PS891007-8-8	D-23	S2102-4-4	D-29	S2507-12-12	D-32
PS810103-8-8	D-6	PS891010-8-8	D-24	S2102-6-6	D-29	S2507-16-16	D-32
PS810106-8-8	D-6	PS8910JM-8-8	D-24	S2102-8-8	D-29	S2507-6-6	D-32
PS810110-8-8	D-7	PS89JM02-8-8	D-24	S2103-12-12	D-29	S2507-8-8	D-32
PS8101JM-8-8	D-7	PS89JM03-10-10	D-24	S2103-16-16	D-29	S2510-12-12	D-32
PS810202-8-8	D-7	PS89JM03-8-8	D-24	S2103-4-4	D-29	S2510-6-6	D-32
PS810203-8-8	D-8	PS89JM05-8-8	D-25	S2103-6-6	D-29	S2510-8-8	D-32
PS810206-8-8	D-8	PS89JM06-8-8	D-25	S2103-8-8	D-29	S2-ACV-02-FP	C-5
PS810210-8-8	D-8	PS89JM07-8-8	D-25	S2107-12-12	D-29	S2-ACV-02-MP	C-5
PS8102JM-8-8	D-8	PS89JM10-8-8	D-25	S2107-16-16	D-29	S2-ACV-03-BHB	C-5
PS810302-8-8	D-9	PS89JMJM-10-10	D-25	S2107-4-4	D-29	S2-ACV-03-HB	C-5
PS810303-10-10	D-9	PS89JMJM-8-8	D-25	S2107-6-6	D-29	S2-ACV-04-BHB	C-5
PS810303-8-8	D-9	PS8A-RPR	D-26	S2107-8-8	D-29	S2-ACV-04-FP	C-5
PS810306-8-8	D-9	PS8-RPR	D-26	S2110-12-12	D-29	S2-ACV-04-HB	C-5
PS810310-8-8	D-10	PS8W-RPR	D-26	S2110-6-6	D-29	S2-ACV-04-MP	C-5
PS8103JM-10-10	D-10	PS8Y-RPR	D-26	S2110-8-8	D-29	S2-ANS-02-FP	C-6
PS8103JM-8-8	D-10	PSEMA3TA*	F-10	S22	A-13	S2-ANS-02-MP	C-6
PS810502-8-8	D-10	PSEMA3TAS*	F-10	S2201-12-12	D-30	S2-ANS-03-BHB	C-6
PS810503-10-10	D-11	PSPTA*	F-10	S2201-4-4	D-30	S2-ANS-03-HB	C-6
PS810503-8-8	D-11	PSTA*	F-10	S2201-6-6	D-30	S2-ANS-04-BHB	C-6
PS810506-8-8	D-11	RF-251-4FP	A-19	S2201-8-8	D-30	S2-ANS-04-FP	C-6
PS810510-8-8	D-11	RF-251-4HB	A-19	S2202-12-12	D-30	S2-ANS-04-HB	C-6
PS8105JM-10-10	D-11	RF-251-4MP	A-19	S2202-4-4	D-30	S2-ANS-04-MP	C-6
PS8105JM-8-8	D-11	RF-251-4PL	A-19	S2202-6-6	D-30	S2-ANV-02-FP	C-7
PS811002-8-8	D-12	RF-251-6FP	A-19	S2202-8-8	D-30	S2-ANV-02-MP	C-7
PS811003-8-8	D-12	RF-251-6HB	A-19	S2203-12-12	D-30	S2-ANV-03-BHB	C-7
PS811006-8-8	D-12	RF-251-6MP	A-19	S2203-16-16	D-30	S2-ANV-03-HB	C-7
PS811010-8-8	D-12	RF-251-6PL	A-19	S2203-4-4	D-30	S2-ANV-04-BHB	C-7
PS8110JM-8-8	D-13	RF-251-8MP	A-19	S2203-6-6	D-30	S2-ANV-04-FP	C-7
PS81JM02-8-8	D-13	RF-251-8PL	A-19	S2203-8-8	D-30	S2-ANV-04-HB	C-7
PS81JM03-10-10	D-13	RF-254-4FP	A-20	S2207-12-12	D-30	S2-ANV-04-MP	C-7
PS81JM03-8-8	D-13	RF-254-4HB	A-20	S2207-16-16	D-30	S2-APV-02-FP	C-5
PS81JM06-8-8	D-13	RF-254-4MP	A-20	S2207-4-4	D-30	S2-APV-03-HB	C-5
PS81JM10-8-8	D14	RF-254-4PL	A-20	S2207-6-6	D-30	S2-APV-04-FP	C-5
PS81JMJM-8-8	D14	RF-254-6FP	A-20	S2207-8-8	D-30	S2-APV-04-HB	C-5
PS890102-8-8	D-15	RF-254-6HB	A-20	S2210-12-12	D-30	S2C	A-11
PS890103-8-8	D-15	RF-254-6MP	A-20	S2210-6-6	D-30	S2-PCV-02-FP	C-5
PS890105-8-8	D-16	RF-254-6PL	A-20	S2210-8-8	D-30	S2-PCV-02-MP	C-5
PS890106-8-8	D-16	RF-371-6FP	A-19	S23	A-13	S2-PCV-03-BHB	C-5

Appendices



Appendices

Part No.	Page	Part No.	Page	Part No.	Page	Part No.	Page
S2-PCV-03-HB	C-5	S6-PCV-04-HB	C-5	SH12-62N	B-8	SM-751-12FB	B-13
S2-PCV-04-BHB	C-5	S6-PCV-04-MP	C-5	SH12-62-T20	B-8	SM-751-12FO	B-13
S2-PCV-04-FP	C-5	S6-PCV-06-FP	C-5	SH12-62-T24	B-8	SM-751-12FP	B-13
S2-PCV-04-HB	C-5	S6-PCV-06-HB	C-5	SH12-63L	B-8	SM-751-16FB	B-13
S2-PCV-04-MP	C-5	S6-PCV-06-MP	C-5	SH12-63N	B-8	SM-751-16FO	B-13
S2-PNS-02-FP	C-6	S6-PCV-08-FP	C-5	SH12-63-T20	B-8	SM-751-16FP	B-13
S2-PNS-02-MP	C-6	S6-PCV-08-HB	C-5	SH12-63-T24	B-8	SM-752-12FB	B-13
S2-PNS-03-BHB	C-6	S6-PCV-08-MP	C-5	SH1-62	B-7	SM-752-12FO	B-13
S2-PNS-03-HB	C-6	S6-PNS-04-FP	C-6	SH1-62-T4	B-7	SM-752-12FP	B-13
S2-PNS-04-BHB	C-6	S6-PNS-04-HB	C-6	SH1-63	B-7	SM-752-16FB	B-13
S2-PNS-04-FP	C-6	S6-PNS-04-MP	C-6	SH1-63-T4	B-7	SM-752-16FO	B-13
S2-PNS-04-HB	C-6	S6-PNS-06-FP	C-6	SH2016-62	B-8	SM-752-16FP	B-13
S2-PNS-04-MP	C-6	S6-PNS-06-HB	C-6	SH2016-63	B-8	SMA3-200	F-25
S2-PNV-02-FP	C-7	S6-PNS-06-MP	C-6	SH2020-62	B-8	SMA3-2000	F-25
S2-PNV-02-MP	C-7	S6-PNS-08-FP	C-6	SH2020-63	B-8	SMA3-400	F-5, F-25
S2-PNV-03-BHB	C-7	S6-PNS-08-HB	C-6	SH2024-62	B-8	SMA3-4000	F-25
S2-PNV-03-HB	C-7	S6-PNS-08-MP	C-6	SH2024-63	B-8	SMA3-800	F-25
S2-PNV-04-BHB	C-7	S6-PNV-04-FP	C-7	SH2-62	B-7	SSH12-62LY	B-8
S2-PNV-04-FP	C-7	S6-PNV-04-HB	C-7	SH2-62-T6	B-7	SSH12-62NY	B-8
S2-PNV-04-HB	C-7	S6-PNV-04-MP	C-7	SH2-63	B-7	SSH12-62Y-T20	B-8
S2-PNV-04-MP	C-7	S6-PNV-06-FP	C-7	SH2-63-T6	B-7	SSH12-62Y-T24	B-8
S2-PPV-02-FP	C-5	S6-PNV-06-HB	C-7	SH2C	A-6	SSH12-63LY	B-8
S2-PPV-03-HB	C-5	S6-PNV-06-MP	C-7	SH2C-E	A-6	SSH12-63NY	B-8
S2-PPV-04-FP	C-5	S6-PNV-08-FP	C-7	SH3-62	B-7	SSH12-63Y-T20	B-8
S2-PPV-04-HB	C-5	S6-PNV-08-HB	C-7	SH3-62-T8	B-7	SSH12-63Y-T24	B-8
S6-ACV-04-FP	C-5	S6-PNV-08-MP	C-7	SH3-63	B-7	SSH1-62Y	B-7
S6-ACV-04-HB	C-5	SAE-500	B-22	SH3-63-T8	B-7	SSH1-62Y-T4	B-7
S6-ACV-04-MP	C-5	SAF-500	B-22	SH3C	A-6	SSH1-63Y	B-7
S6-ACV-06-FP	C-5	SC-690	F-15, F-16	SH3C-E	A-6	SSH1-63Y-T4	B-7
S6-ACV-06-HB	C-5	SCA-1/2-EMA-3	F-9, F-15, F-25	SH4-62	B-7	SSH2016-62Y	B-8
S6-ACV-06-MP	C-5	SCA-1/2-EMA-3-S	F-9, F-15, F-25	SH4-62-T10	B-7	SSH2016-63Y	B-8
S6-ACV-08-FP	C-5	SCA-7/16-EMA-3	F-5	SH4-63	B-7	SSH2020-62Y	B-8
S6-ACV-08-HB	C-5	SCC-110	F-5	SH4-63-T10	B-7	SSH2020-63Y	B-8
S6-ACV-08-MP	C-5	SCC-120	F-5	SH6-62	B-7	SSH2024-62Y	B-8
S6-ANS-04-FP	C-6	SCDA-150	F-9, F-10	SH6-62-T12	B-7	SSH2024-63Y	B-8
S6-ANS-04-HB	C-6	SCDA-410	F-15	SH6-63	B-7	SSH2-62Y	B-7
S6-ANS-04-MP	C-6	SCDA-KIT-152	F-9	SH6-63-T12	B-7	SSH2-62Y-T6	B-7
S6-ANS-06-FP	C-6	SCG-022	F-9, F-15	SH67E-62K	B-8	SSH2-63Y	B-7
S6-ANS-06-HB	C-6	SCJA-1/4	F-5	SH67E-63K	B-8	SSH2-63Y-T6	B-7
S6-ANS-06-MP	C-6	SCJR-0250-4MP	F-5	SH67F-62K	B-8	SSH3-62Y	B-7
S6-ANS-08-FP	C-6	SCJR-0250-EMA	F-5	SH67F-63K	B-8	SSH3-62Y-T8	B-7
S6-ANS-08-HB	C-6	SCJR-0250-PD	F-5	SH67G-62K	B-8	SSH3-63Y	B-7
S6-ANS-08-MP	C-6	SCJR-5800-4MP	F-5	SH67G-63K	B-8	SSH3-63Y-T8	B-7
S6-ANV-04-FP	C-7	SCJR-5800-EMA	F-5	SH67J-62K	B-8	SSH4-62Y	B-7
S6-ANV-04-HB	C-7	SCJR-5800-PD	F-5	SH67J-63K	B-8	SSH4-62Y-T10	B-7
S6-ANV-04-MP	C-7	SCJR-8700-4MP	F-5	SH8-62	B-7	SSH4-63Y	B-7
S6-ANV-06-FP	C-7	SCJR-8700-EMA	F-5	SH8-62-T16	B-7	SSH4-63Y-T10	B-7
S6-ANV-06-HB	C-7	SCJR-8700-PD	F-5	SH8-63	B-7	SSH6-62Y	B-7
S6-ANV-06-MP	C-7	SCK-102-02-02	F-15, F-16	SH8-63-T16	B-7	SSH6-62Y-T12	B-7
S6-ANV-08-FP	C-7	SCK-102-02-08	F-9	SH8C	A-7	SSH6-63Y	B-7
S6-ANV-08-HB	C-7	SCK-102-03-12	F-15	SH9C	A-7	SSH6-63Y-T12	B-7
S6-ANV-08-MP	C-7	SCK-102-05-02	F-15	SM-251-4FB	B-13	SSH67E-62KY	B-8
S6-KCV-04-FP	C-5	SCK-108-03-18	F-9	SM-251-4FP	B-13	SSH67E-63KY	B-8
S6-KCV-04-HB	C-5	SCK-313-02-31	F-15, F-16	SM-251-6FB	B-13	SSH67F-62KY	B-8
S6-KCV-04-MP	C-5	SCM-150-1-01	F-9, F-10	SM-251-6FO	B-13	SSH67F-63KY	B-8
S6-KCV-06-FP	C-5	SCM-150-1-02	F-9, F-10	SM-251-6FP	B-13	SSH67G-62KY	B-8
S6-KCV-06-HB	C-5	SCM-150-TM	F-9	SM-252-4FB	B-13	SSH67G-63KY	B-8
S6-KCV-06-MP	C-5	SCM-350-1-01	F-15, F-16	SM-252-4FP	B-13	SSH67J-62KY	B-8
S6-KCV-08-FP	C-5	SCM-450-1-01	F-15, F-16	SM-252-6FB	B-13	SSH67J-63KY	B-8
S6-KCV-08-HB	C-5	SCMA-VADC-250	F-15	SM-252-6FO	B-13	SSH8-62Y	B-7
S6-KCV-08-MP	C-5	SCRPR-KIT-150	F-9	SM-252-6FP	B-13	SSH8-62Y-T16	B-7
S6-KNV-04-FP	C-7	SCRPM-210	F-9	SM-501-12FB	B-13	SSH8-63Y	B-7
S6-KNV-04-HB	C-7	SCRPM-220	F-15	SM-501-12FP	B-13	SSH8-63Y-T16	B-7
S6-KNV-04-MP	C-7	SCRPM-001	F-9, F-15	SM-501-8FB	B-13	SSPD242Y	F-19
S6-KNV-06-FP	C-7	SCRPM-002	F-9, F-15	SM-501-8FO	B-13	SSPD343Y	F-19
S6-KNV-06-HB	C-7	SCSN-450	F-9, F-15	SM-501-8FP	B-13	SST-1	B-54
S6-KNV-06-MP	C-7	SCSW-400	F-15, F-16	SM-502-12FB	B-13	SST-2	B-54
S6-KNV-08-FP	C-7	SCT-150-74-02	F-15	SM-502-12FP	B-13	SST-3	B-54
S6-KNV-08-HB	C-7	SCT-150-74-08	F-8, F-9	SM-502-8FB	B-13	SST-4	B-54
S6-KNV-08-MP	C-7	SCTA-1/4	F-9, F-15	SM-502-8FO	B-13	SST-6	B-54
S6-PCV-04-FP	C-5	SH12-62L	B-8	SM-502-8FP	B-13	SST-8	B-54



Appendices

Alpha Numeric Index

Part No.	Page	Part No.	Page	Part No.	Page	Part No.	Page
SST-1M	B-54	1098-0010	A-32	314-5/16	A-41	50001-133-0010	B-8
SST-2M	B-54	1141-62	B-47	318	A-41	50001-138-0260	B-8
SST-3M	B-54	1141-63	B-47	318-1/2	A-41	50001-211-0260	B-17, B-19, B-41, B-43
SST-4M	B-54	1163-60	B-56	318-1/4	A-41	50001-211-0010	B-11
SST-6M	B-54	1163-61	B-56	322	A-41	50001-212-0010	B-55
SST-8M	B-54	1261-0020	A-32	322-3/4	A-41	50001-213-0010	B-8
SST-N1	B-55	14	A-10	322-3/8	A-41	50001-214-0010	B-55
SST-N1M	B-55	14-5B	A-10	330-C3	A-41	50001-217-0010	B-55
SST-N2	B-55	14-5BP	A-10	330-C5	A-41	50001-218-0260	B-17
SST-N2M	B-55	1461-0050	A-32	330-C6	A-41	50001-218-0010	B-8
SST-N3	B-55	1461-0070	A-32	332-E10	A-41	50001-221-0010	B-55
SST-N3M	B-55	1462-0040	A-32	332-E6	A-41	50001-222-0010	B-8
SST-N4	B-55	1462-0100	A-32	332-E7	A-41	50001-224-0010	B-8
SST-N4M	B-55	14-6B	A-10	332-E8	A-41	50001-234-0260	B-8
SST-N6	B-55	14C	A-10	3613001	B-50	50001-327-0010	B-55
SST-N6M	B-55	14F	A-10	3C	A-11	50001-333-0010	B-8
SST-N8	B-55	15	A-10	3C-E	A-11	50005-211-0202	B-39
SST-N8M	B-55	15C	A-10	3E	A-11	5001-215-0010	B-17
ST-N1	B-55	15F	A-10	3F	A-11	5005-4	B-61
ST-N1M	B-55	16	A-10, A-13	4010-2P	B-17	5009-4	B-61
ST-N2	B-55	16-5B	A-10, A-13	4010-3P	B-17, B-19	50-140-4	B-11
ST-N2M	B-55	16-5BP	A-10, A-13	4010-6P	B-17	5050-4	B-43
ST-N3	B-55	16-6B	A-10, A-13	4010-T6	B-17	5205-2M	B-61
ST-N3M	B-55	16-6BP	A-10, A-13	4050-15	B-17	5205-3	B-61
ST-N4	B-55	16-7B	A-10, A-13	4050-15P	B-17	5205-4M	B-60, B-61
ST-N4M	B-55	16E	A-10, A-13	4050-16	B-17	5205-5	B-61
ST-N6	B-55	16G	A-10, A-13	4050-16P	B-17	5205-6	B-61
ST-N6M	B-55	17	A-10, A-13	4050-29BSPP	B-17	5209-2M	B-61
ST-N8	B-55	17E	A-10, A-13	4050-2P	B-17	5209-3	B-61
ST-N8M	B-55	17G	A-10, A-13	4050-2P-T8M	B-17	5209-4M	B-6-, B-61
TC-371	B-46	1C	A-11	4050-3P	B-17	5209-5	B-61
TC-372	B-46	1E	A-11	4050-4	B-17	5209-6	B-61
TL-251-4FP	A-32	1F	A-11	4050-4P	B-17	5E	A-11
TL-251-4MP	A-32	2047-0010	A-32	4050-5	B-17	5EP	A-11
TL-251-6MP	A-32	2123-0030	A-32	4050-5P	B-17	5F	A-11
TL-254-2FP	A-32	24	A-13	4050-6P	B-17	6100-08	B-36
TL-254-2MP	A-32	24-5B	A-13	4050P-T6	B-17	6100-12	B-36
TL-254-4FP	A-32	24-5BP	A-13	4050-T6	B-17	6100-16	B-36
TL-254-4HB	A-32	24-6B	A-13	410	A-42	6100-20	B-36
TL-254-4MP	A-32	24C	A-13	410-N	A-42	6100-24	B-36
TL-254-6HB	A-32	24F	A-13	410-S	A-42	6105-08	B-37
TL-501-12FP	A-32	25	A-13	410-SV	A-42	6105-12	B-37
TL-501-6FP	A-32	25C	A-13	4110-5	B-17	6105-16	B-37
TL-501-6MP	A-32	25F	A-13	4118005	B-11	6105-20	B-37
TL-501-8FP	A-32	2C	A-11	4118006	B-11	6105-24	B-37
TL-501-8MP	A-32	2C-E	A-11	4118007	B-8	6107-08	B-37
TL-504-12MP	A-32	2E	A-11	4128002	B-8	6107-16	B-37
TL-504-4FP	A-32	2F	A-11	4138001	B-11	6107-20	B-37
TL-504-4HB	A-32	3005-2	B-62	4148001	B-8	6107-24	B-37
TL-504-4MP	A-32	3005-3	B-62	4148002	B-11	6108-08	B-61
TL-504-6FP	A-32	3009-2	B-62	4150-5	B-17	6108-16	B-61
TL-504-6HB	A-32	3009-3	B-62	4158001	B-8	6108-20	B-61
TL-504-6MP	A-32	3010-2	B-45	415-N	A-42	6108-24	B-61
TL-504-8HB	A-32	3010-3	B-45	415-S	A-42	6109-08	B-61
TL-504-8MP	A-32	3010-3-230	B-45	4250-15	B-19	6109-16	B-61
TR-37	B-60, B-62	3050-2	B-45	4250-15P	B-19	6109-20	B-61
UC-251-4FP	A-26	3050-3	B-45	4250-3P	B-19	6109-24	B-61
UC-251-4MP	A-26	3050-3-231	B-45	4250-4	B-19	6110-08	B-36
UC-251-6FP	A-26	3060-0109	A-32	4250-4P	B-19	6110-12	B-36
UC-251-6MP	A-26	3061-0109	A-32	50001-010-0010	B-55	6110-16	B-36
UC304F-4	A-26	308	A-41	50001-013-0010	B-8	6110-20	B-36
UC-304M-4	A-26	3080-0020	A-32	50001-015-0010	B-8	6110-24	B-36
UC-340F-6	A-26	3081-0020	A-32	50001-110-0010	B-55	6115-08	B-37
UC340M-6	A-26	310	A-41	50001-112-0010	B-11, B-55	6115-12	B-37
OC	A-11	310-1/2	A-41	50001-113-0260	B-17	6115-16	B-37
OE	A-11	310-3/8	A-41	50001-115-0010	B-11	6115-20	B-37
OF	A-11	310-5/16	A-41	50001-116-0260	B-17, B-19	6115-24	B-37
1095-0020	A-32	311	A-41	50001-116-0010	B-8	6120-08	B-36
1095-0040	A-32	311-3/8	A-41	50001-123-0010	B-11	6120-12	B-36
1096-0010	A-32	314	A-41	50001-124-0010	B-8	6120-16	B-36
1097-0010	A-32	314-3/8	A-41	50001-126-0010	B-11	6120-20	B-36



Appendices

Appendices

Part No.	Page	Part No.	Page	Part No.	Page	Part No.	Page
6120-24.....	B-36	9250-16-320	B-41				
6125-08.....	B-37	9250-334.....	B-41				
6125-12.....	B-37	9250-4-320	B-41				
6125-16.....	B-37	9250-6-320	B-41				
6125-20.....	B-37	9507-4-1	B-62				
6125-24.....	B-37	9C	A-11				
6130-08.....	B-36	9CP	A-11				
6130-12.....	B-36						
6130-16.....	B-36						
6130-20.....	B-36						
6130-24.....	B-36						
6135-08.....	B-37						
6135-12.....	B-37						
6135-16.....	B-37						
6135-20.....	B-37						
6135-24.....	B-37						
6601-12-10	B-11						
6601-12-12	B-11						
6601-16-16	B-11						
6601-2-4	B-11						
6601-4-4	B-11						
6601-6-6	B-11						
6601-8-10	B-11						
6602-12-10	B-11						
6602-12-12	B-11						
6602-16-16	B-11						
6602-2-4	B-11						
6602-4-4	B-11						
6602-6-6	B-11						
6602-8-10	B-11						
6608-10-10	B-11						
6608-12-10	B-11						
6608-12-12	B-11						
6608-16-16	B-11						
6608-6-6	B-11						
6608-8-10	B-11						
6610-10-10	B-11						
6610-12-10	B-11						
6610-12-12	B-11						
6610-16-16	B-11						
6610-6-6	B-11						
6610-8-10	B-11						
6657-12M.....	B-60						
6657-16M.....	B-60						
6659-12M.....	B-60						
6659-16M.....	B-60						
7820123.....	B-50						
8010-15.....	B-17, B-19, B-39, B-41, B-43						
8010-15P.....	B-17, B-19, B-39, B-41						
8010-15P-DC	B-17, B-19						
8010-16	B-17, B-39, B-41, B-43						
8010-16P	B-17, B-39, B-41						
8010-29BSPP	B-17						
8010-4.....	B-17, B-19, B-39, B-41, B-43						
8010-4P	B-17, B-19, B-39, B-41						
8010-4P-DC	B-17, B-19						
8010-5.....	B-17						
8010-5P	B-17						
8050-0110.....	A-32						
8052-0319.....	A-32						
8250-15.....	B-39						
8250-16.....	B-39						
8250-4.....	B-39						
8278-0050.....	A-32						
8624-0070.....	A-32						
8787-0040.....	A-32						
8788-0030.....	A-32						
8C	A-11						
8CP	A-11						
9250-15-320	B-41						

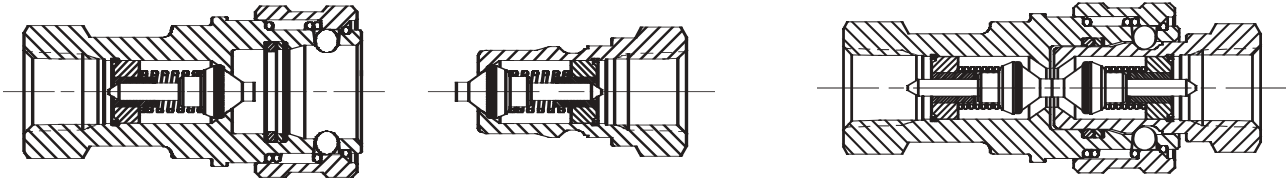

Air Inclusion: The ambient atmosphere forced into the system during the connection of the quick disconnect halves.

Break-Away: Automatic disconnection of a coupling when an axial separation force is applied.

Brinelling: Dimples or grooves worn into the shoulder of a male half by the locking balls in the female half.

Burst Pressure: The pressure at which a device loses the capability to retain pressure.

Case Hardening: Hardening the surface of low carbon steel..

Cold Flow: Continued deformation under load.

Connect Under Pressure: Ability to connect coupling halves with internal line pressure applied to either both sides or one side.

Coupling, Female Half: Other nomenclature “couple”, “socket”, “body”.

Coupling, Male Half: Other nomenclature “nipple”, “plug”, “adapter”.

Coupling, Quick Disconnect: A component which can quickly join or separate a fluid line without the use of tools or special devices.

Differential Pressure (ΔP): The difference in pressure between any two points of a system or a component.

Double-Acting Sleeve: Permits push-to-connect and pull-to-disconnect convenience on implement line when female half is clamp mounted and connected with a hose.

Dust Cap: Dust or dirt repelling enclosure for both halves.

Dust Plug: Dust or dirt repelling enclosure both halves.

Flow Checking: Occurs when a nipple valve closes during flow conditions, such as when quickly lowering a heavy implement. (Also called Check Off, Back Checking or Lock-up.)

Flush Position (Valve): When the coupler valve is fully open, allowing maximum oil flow.

Force to Connect: Axial and/or rotational force required to make a complete connection.

Force to Disconnect: The reverse of the above.

Induction Hardening: Localized hardening of medium carbon steel.

Peak Pressure: Maximum momentary pressure encountered in the operation of a component.

Pressure Cap: Cap which incorporates a seal capable of withstanding the rated pressures on the male half.

Pressure Impulse Test: Subjecting a component to a specified pressure at a specified rate of increase or decrease for a specified time limit.

Pressure Operating: The pressure at which a system is operated.

Pressure Plug: Plug which incorporates a seal capable of withstanding the rated pressures on the female half.

Proof Pressure: The non-destructive test pressure in excess of the maximum rated operating pressure.

Push To Connect (Auto Lock): Locking arrangement which permits one handed connection by pushing the nipple into the coupler.

Rated Pressure: The maximum pressure at which a product is designed to operate.

Single-Acting Sleeve: Permits pull-to-disconnect convenience on implement line when female body is clamp mounted. Making connection requires manually pulling female body forward, inserting male tip, then allowing body and tip to return to original position in the clamp.

Sleeve Lock: Arrangement which provides an additional lock which must be actuated before the locking sleeve can be retracted.

Spillage: The fluid removed from the system due to disconnection of a coupling assembly. This is the fluid trapped between the mating seal and the valve seal of the coupling halves.

Surge Pressure: The pressure existing from surge conditions.

Surge Flows: A rapid increase in fluid flow.

Thermal Build-Up: Hydraulic pressure caused by expansion of the fluid due to heat from an external source such as sunlight.

Trapped Pressure: Pressurized hydraulic fluid trapped behind closed coupling valve

Twist Lock: A locking arrangement which requires a rotational actuation to unlock the mating halves.

Types of Quick Disconnect Coupling Valves

Straight-Thru (ST): This provides straight through flow.

Double Shut-off Valve (DSO): A valve in the female half and a valve in the male half.

Single Shut-off Valve (SSO): Generally, a valve in the female half with no valve in the male half.

NOTE: Refer to Parker’s Publication No. 3800-B1.0: Safety Guide for Selecting and Using Quick Action Couplings and Related Accessories.

The items described in this document are hereby offered for sale at prices to be established by Parker Hannifin Corporation, its subsidiaries and its authorized distributors. This offer and its acceptance by any customer ("Buyer") shall be governed by all of the following Terms and Conditions. Buyer's order for any item described in its document, when communicated to Parker Hannifin Corporation, its subsidiary or an authorized distributor ("Seller") verbally or in writing, shall constitute acceptance of this offer.

1. Terms and Conditions of Sale: All descriptions, quotations, proposals, offers, acknowledgments, acceptances and sales of Seller's products are subject to and shall be governed exclusively by the terms and conditions stated herein. Buyer's acceptance of any offer to sell is limited to these terms and conditions. Any terms or conditions in addition to, or inconsistent with those stated herein, proposed by Buyer in any acceptance of an offer by Seller, are hereby objected to. No such additional, different or inconsistent terms and conditions shall become part of the contract between Buyer and Seller unless expressly accepted in writing by Seller. Seller's acceptance of any offer to purchase by Buyer is expressly conditional upon Buyer's assent to all the terms and conditions stated herein, including any terms in addition to, or inconsistent with those contained in Buyer's offer. Acceptance of Seller's products shall in all events constitute such assent.

2. Payment: Payment shall be made by Buyer net 30 days from the date of delivery of the items purchased hereunder. Amounts not timely paid shall bear interest of 1% for each month or a portion thereof that Buyer is late in making payment. Any claims by Buyer for omissions or shortages in a shipment shall be waived unless Seller receives notice thereof within 30 days after Buyer's receipt of the shipment.

3. Delivery: Unless otherwise provided on the face hereof, delivery shall be made F.O.B. Seller's plant. Regardless of the method of delivery, however, risk of loss shall pass to Buyer upon Seller's delivery to a carrier. Any delivery dates shown are approximate only and Seller shall have no liability for any delays in delivery.

4. Warranty: Seller warrants that the items sold hereunder shall be free from defects in material or workmanship for a period of 365 days from the date of shipment to Buyer. **THIS WARRANTY COMPRISES THE SOLE AND ENTIRE WARRANTY PERTAINING TO ITEMS PROVIDED HEREUNDER. SELLER MAKES NO OTHER WARRANTY, GUARANTEE, OR REPRESENTATION OF ANY KIND WHATSOEVER. ALL OTHER WARRANTIES, INCLUDING BUT NOT LIMITED TO, MERCHANTABILITY AND FITNESS FOR PURPOSE, WHETHER EXPRESS, IMPLIED, OR ARISING BY OPERATION OF LAW, TRADE USAGE, OR COURSE OF DEALING ARE HEREBY DISCLAIMED.**

NOTWITHSTANDING THE FOREGOING, THERE ARE NO WARRANTIES WHATSOEVER ON ITEMS BUILT OR ACQUIRED WHOLLY OR PARTIALLY, TO BUYER'S DESIGNS OR SPECIFICATIONS.

5. Limitation Of Remedy: SELLER'S LIABILITY ARISING FROM OR IN ANY WAY CONNECTED WITH THE ITEMS SOLD OR THIS CONTRACT SHALL BE LIMITED EXCLUSIVELY TO REPAIR OR REPLACEMENT OF THE ITEMS SOLD OR REFUND OF THE PURCHASE PRICE PAID BY BUYER, AT SELLER'S SOLE OPTION. IN NO EVENT SHALL SELLER BE LIABLE FOR ANY INCIDENTAL, CONSEQUENTIAL OR SPECIAL DAMAGES OF ANY KIND OR NATURE WHATSOEVER, INCLUDING BUT NOT LIMITED TO LOST PROFITS ARISING FROM OR IN ANY WAY CONNECTED WITH THIS AGREEMENT OR ITEMS SOLD HEREUNDER, WHETHER ALLEGED TO ARISE FROM BREACH OF CONTRACT, EXPRESS OR IMPLIED WARRANTY, OR IN TORT, INCLUDING WITHOUT LIMITATION, NEGLIGENCE, FAILURE TO WARN OR STRICT LIABILITY.

6. Changes, Reschedules and Cancellations: Buyer may request to modify the designs or specifications for the items sold hereunder as well as the quantities and delivery dates thereof, or may request to cancel all or part of this order, however, no such requested modification or cancellation shall become part of the contract between Buyer and Seller unless accepted by Seller in a written amendment to this Agreement. Acceptance of any such requested modification or cancellation shall be at Seller's discretion, and shall be upon such terms and conditions as Seller may require.

7. Special Tooling: A tooling charge may be imposed for any special tooling, including without limitation, dies, fixtures, molds and patterns, acquired to manufacture items sold pursuant to this contract. Such special tooling shall be and remain Seller's property notwithstanding payment of any charges by Buyer. In no event will Buyer acquire any interest in apparatus belonging to Seller which is utilized in the manufacture of the items sold hereunder, even if such apparatus has been specially converted or adapted for such manufacture and notwithstanding any charges paid by Buyer therefore. Unless otherwise agreed, Seller shall have the right to alter, discard or otherwise dispose of any special tooling or other property in its sole discretion at any time.

8. Buyer's Property: Any designs, tools, patterns, materials, drawings, confidential information or equipment furnished by the Buyer or any other items which become Buyer's property, may be considered obsolete and may be destroyed by Seller after two (2) consecutive years have elapsed without Buyer placing an order for the items which are manufactured using such property. Seller shall not be responsible for any loss or damage to such property while it is in Seller's possession or control.

9. Taxes: Unless otherwise indicated on the face hereof, all prices and charges are exclusive of excise, sales, use, property, occupational or like taxes which may be imposed by any taxing authority upon the manufacture, sale or delivery of the items sold hereunder. If any such taxes must be paid by Seller or if Seller is liable for the collection of such tax, the amount thereof shall be in addition to the amounts for the items sold. Buyer agrees to pay all such taxes or to reimburse Seller therefore upon receipt of its invoice. If Buyer claims exemption from any sales, use or other tax imposed by any taxing authority, Buyer shall save Seller harmless from and against any such tax, together with any interest or penalties thereon which may be assessed if the items are held to be taxable.

10. Indemnity For Infringement of Intellectual Property Rights: Seller shall have no liability for infringement of any patents, trademarks, copyrights, trade dress, trade secrets or similar rights except as provided in this Part 10. Seller will defend and indemnify Buyer against allegations of infringement of U.S. patents, U.S. trademarks, copyrights, trade dress and trade secrets (hereinafter 'Intellectual Property Rights'). Seller will defend at its expense and will pay the cost of any settlement or damages awarded in an action brought against Buyer based on an allegation that an item sold pursuant to this contract infringes the Intellectual Property Rights of a third party. Seller's obligation to defend and indemnify Buyer is contingent on Buyer notifying Seller within ten (10) days after Buyer becomes aware of such allegations of infringement, and Seller having sole control over the defense of any allegations or actions including all negotiations for settlement or compromise. If an item sold hereunder is subject to a claim that it infringes the Intellectual Property Rights of a third party, Seller may, at its sole expense and option, procure for Buyer the right to continue using said item, replace or modify said item so as to make it noninfringing, or offer to accept return of said item and return the purchase price less a reasonable allowance for depreciation. Notwithstanding the foregoing, Seller shall have no liability for claims of infringement based on information provided by Buyer, or directed to items delivered hereunder for which the designs are specified in whole or part by Buyer, or infringements resulting from the modification, combination or use in a system of any item sold hereunder. The foregoing provisions of this Part 10 shall constitute Seller's sole and exclusive liability and Buyer's sole and exclusive remedy for infringement of Intellectual Property rights.

If a claim is based on information provided by Buyer or if the design for an item delivered hereunder is specified in whole or in part by Buyer, Buyer shall defend and indemnify Seller for all costs, expenses or judgments resulting from any claim that such item infringes any patent, trademark, copyright, trade dress, trade secret or any similar right.

11. Force Majeure: Seller does not assume the risk of and shall not be liable for delay or failure to perform any of Seller's obligations by reason of circumstances beyond the reasonable control of Seller (hereinafter 'Events of Force Majeure'). Events of Force Majeure shall include without limitation, accidents, acts of God, strikes or labor disputes, acts, laws, rules or regulations of any government or government agency, fires, floods, delays or failures in delivery of carriers or suppliers, shortages of materials and any other cause beyond Seller's control.

12. Entire Agreement/Governing Law: The terms and conditions set forth herein, together with any amendments, modifications and any different terms or conditions expressly accepted by Seller in writing, shall constitute the entire Agreement concerning the items sold, and there are no oral or other representations or agreements which pertain thereto. This Agreement shall be governed in all respects by the law of the State of Ohio. No actions arising out of the sale of the items sold hereunder or this Agreement may be brought by either party more than two (2) years after the cause of action accrues.



Parker Hannifin Corporation
 6035 Parkland Blvd.
 Cleveland, Ohio 44124-4141
 Telephone: (216) 896-3000
 Fax: (216) 896-4000
 www.parker.com

Parker Hannifin Corporation

About Parker Hannifin Corporation

Parker Hannifin is a leading global motion-control company dedicated to delivering premier customer service. A Fortune 500 corporation listed on the New York Stock Exchange (PH), our components and systems comprise over 1,400 product lines that control motion in some 1,000 industrial and aerospace markets. Parker is the only manufacturer to offer its customers a choice of hydraulic, pneumatic, and electromechanical motion-control solutions. Our Company has the largest distribution network in its field, with over 7,500 distributors serving nearly 400,000 customers worldwide.

Parker's Charter

To be a leading worldwide manufacturer of components and systems for the builders and users of durable goods. More specifically, we will design, market and manufacture products controlling motion, flow and pressure. We will achieve profitable growth through premier customer service.

Product Information

North American customers seeking product information, the location of a nearby distributor, or repair services will receive prompt attention by calling the Parker Product Information Center at our toll-free number: 1-800-C-PARKER (1-800-272-7537). In Europe, call: 00800-C-PARKER-H (00800-2727-5374).

The Aerospace Group is a leader in the development, design, manufacture and servicing of control systems and components for aerospace and related high-technology markets, while achieving growth through premier customer service.



The Climate & Industrial Controls Group designs, manufactures and markets system-control and fluid-handling components and systems to refrigeration, air-conditioning and industrial customers worldwide.



The Fluid Connectors Group designs, manufactures and markets rigid and flexible connectors, and associated products used in pneumatic and fluid systems.



The Seal Group designs, manufactures and distributes industrial and commercial sealing devices and related products by providing superior quality and total customer satisfaction.



The Hydraulics Group designs, produces and markets a full spectrum of hydraulic components and systems to builders and users of industrial and mobile machinery and equipment.



The Filtration Group designs, manufactures and markets quality filtration and clarification products, providing customers with the best value, quality, technical support, and global availability.



The Automation Group is a leading supplier of pneumatic and electromechanical components and systems to automation customers worldwide.



The Instrumentation Group is a global leader in the design, manufacture and distribution of high-quality critical flow components for worldwide process instrumentation, ultra-high-purity, medical and analytical applications.



Fluid Connectors Group Sales Offices

**Parker Hannifin Corporation
Quick Coupling Division**
8145 Lewis Road
Minneapolis, MN 55427
(763) 525-4240
FAX (763) 544-3418

**Parker Hannifin Rak S.A.
Quick Coupling Division**
17, rue des Buchillons
Z.I. du Mont-Blanc B.P. 524
74112 Annemasse Cedex
France
Tel. 33 4 50 87 80 80
FAX 33 4 50 87 80 14

Great Lakes Region
300 Parker Drive
Otsego, MI 49078
(616) 694-2550
FAX (616) 694-4614

Cleveland Region
6035 Parkland Blvd.
Cleveland, OH 44124
(216) 896-3000
FAX (216) 896-4022

Minneapolis Region
8145 Lewis Road
Minneapolis, MN 55044
(763) 513-3535
FAX (763) 544-3418

Northeast Region
2605 Kruser Rd.
P.O. Box 8847
Trenton, NJ 08650
(609) 586-5151
FAX (609) 586-3149

Pacific Region
6458 N. Basin Ave.
Portland, OR 97217
(503) 283-1020
FAX (503) 283-2201

Southeast Region
125 East Meadowview Rd.
Greensboro, NC 27406
(336) 373-1761
FAX (336) 378-0913

Southwest Region
800 South 4th Ave.
Mansfield, TX 76063
(817) 473-4431
FAX (817) 473-8078

**CANADA
Parker Hannifin (Canada), Inc.**
4635 Durham Road South
P.O. Box 158
Grimsby, Ontario L3M 4G4
(905) 945-2274
FAX (905) 945-3946

Your complete source for quality tube fittings, hose and hose fittings, brass fittings and valves, quick-disconnect couplings, and assembly tools, locally-available from a worldwide network of authorized distributors.

Fittings & Couplings:

Available in inch and metric sizes covering SAE, BSP, DIN, GAZ, JIS and ISO thread configurations, manufactured from steel, stainless steel, brass, aluminum, nylon and thermoplastic.

Hose, Tubing and Bundles:

Available in a wide variety of sizes and materials including rubber, wire-reinforced thermoplastic, hybrid and custom compounds.

Worldwide Availability:

Parker operates Fluid Connectors manufacturing locations and sales offices throughout North America, South America, Europe and Asia-Pacific.

For information, contact the nearest Regional Sales Office listed, or **call toll-free 1-800-C-PARKER** (1-800-272-7537).



Parker Hannifin Corporation
**Fluid Connectors Group
Quick Coupling Division**
8145 Lewis Road
Minneapolis, MN 55427
www.parker.com/quickcouplings

