

The Eaton logo is displayed in a bold, black, sans-serif font. The letters 'E', 'A', and 'T' are connected, with a dot between the 'T' and 'O', and another 'N' to the right. The logo is centered within a white rectangular area that is part of a larger image showing thick, braided metal hoses.

Everflex® PTFE Hose

Marketing Catalog

A large industrial factory floor is shown, featuring complex machinery and workers. In the foreground, there are large, dark, cylindrical rollers. In the middle ground, a worker in a brown shirt stands near a control panel. In the background, another worker in a green shirt stands near a large white roll of material. The machinery is primarily blue and white, with various platforms and railings. The lighting is bright, typical of an industrial setting.

**When Rubber Hose is
Not Enough**

Table of Contents

Application Data	
Safety Information.....	3
Steam Hose Safety Information	4
Steam Temperatures	5
Diverse and Demanding Applications	6
Hose Ordering and Packaging Specifications	7
Hose Length Information	8
Smooth Bore PTFE Hose	
Smooth Bore Bulk Hose.....	9-13
Hi-PSI Series	13
Everswage Hose Ends	14-18
Everswage Hose End Component Parts	19-20
Conduit Shielding Fittings	21
Everswage Fitting Bill of Material Cross-Reference	22
'E' Series Crimp Hose Ends.....	23-30
Field Attachable Fittings Cross Reference	31
Hose Fittings - Field Attachable	32-35
Hose and Fitting Cross Reference	36
Smooth Bore Hose Accessories	37-38
Convuluted Hose	
Conv-O-Crimp Bulk Hose	39
Conv-O-Crimp Hose Ends	40-42
Assembly Equipment & Procedures	
Everswage Equipment & Tooling	43
Everswage Tooling Selector Chart.....	44
Everswage Assembly Procedures	45-47
'E' Series Tooling Selector Chart	48
'E' Series Crimp Assembly Procedures	49-50
Conv-O-Crimp Equipment and Tooling.....	51
Conv-O-Crimp Assembly Procedures.....	52-55
Conv-O-Crimp Fitting Locator Adjustment and Tooling Selector Chart	56
Field Attachable Fittings	57-58
Chemical Resistance Chart	
Partial List of Chemicals.....	59-64
Claim Information	
Claim	65

Application Data

Important Safety Information

READ THIS INFORMATION BEFORE USING THIS CATALOG.

This catalog is intended as a guide in selecting the proper hose and fittings for the applications listed herein. It contains cautions, warnings, guidelines and directions for the safe and proper use of Everflex hose. All these directions and footnotes should be read and understood before specifying or using any of these hoses.

Symbols, boxes, boldface type, etc. are used to call attention to these instructions. Be sure to read and understand them before proceeding further with this information.

 This symbol is used when personal injury is possible.

 **WARNING:** A failure of PTFE hose in service can result in personal injury, death or damage of property.

Do not use PTFE hose at temperatures or pressures above those recommended by the manufacturer. All operators must be thoroughly trained in the care and use of this hose and must at all times wear protective clothing. A hose or system failure could cause the release of a poisonous, corrosive or flammable material.

 **WARNING:** These hoses can be used to convey hazardous chemicals, steam, hot liquids or other dangerous materials which can cause death, serious injury including burns, pressure wounds or chemical exposure if released accidentally. They should, therefore, only be handled or worked on by personnel properly trained in the safe handling of the materials or chemicals being conveyed in the hoses.

 **WARNING:** In the case of low viscosity hydrocarbon fluids moving at high flow rates, the need to use conductive tubed PTFE hose products is necessary.

 **WARNING:** Selection of the proper end fittings for the hose end application is essential to the proper operation and safe use of the hose and related equipment. Inadequate attention to the selection of the end fittings for your application can result in leaking or the hose ends blowing off the hose, leading to serious personal injury, death or property damage.

The use or intermixing of fittings and hose not specifically engineered and designed for use with the Eaton Everflex equipment may result in the production of an unsafe or unreliable hose assembly. The Eaton limited warranty is contingent upon the fact that only Eaton Everflex end fittings and Eaton Everflex hose be used on Eaton Everflex assembly equipment.

In order to avoid serious bodily injury or property damage resulting from selection of the wrong end fitting, you should carefully review the information in this catalog.

Application Data

Important Safety Information

Make Your Selection With Safety In Mind

- Be sure to select a hose identified as steam hose construction.
 - You must identify the type of service the steam hose is required to accomplish.
 - a) Is the hose manually handled?
 - b) What is the anticipated frequency of use?
 - c) What is the actual pressure of the steam service?
 - d) Is it subject to surges or peak pressures?
 - e) What is the temperature of the steam?
 - f) Saturated (wet) or superheated (dry) steam?
 - g) What are the external conditions in the area where the hose will be used?
- You should recognize that spillage, or accumulations of corrosive chemicals or petroleum based materials externally, can have a deteriorating effect on the hose cover.

Make Sure the Hose is Installed Properly

- Avoid extreme flexing of the hose near the coupling. If necessary, use elbows in the piping system to assure a straight line connection with the hose.
- Installing and using a shut-off valve between the steam source and the hose will maximize service life and operator safety. We consider such a valve mandatory for safe operation.
- The use of spring guards can relieve some of the acute flexing encountered in heavy manual handling applications.
- Provide a suitable means of storing the hose when not in use. A permanent rack or tray will minimize the damage to the hose in storage. Do not hang the hose on a hook, nail, or other device which could cut or damage the hose.

steam hose you select will contribute to increased operator safety. Carefully read and understand the safety information provided on this page and the following pages.

Common Sense with Steam Hose

- Provide operators with adequate safety clothing. Include gloves, rubber boots, full length protective clothing, and eye protection. The objective is to provide protection from scalding burns resulting from splash-back of steam or hot water.
- Ensure that the work area is free of tripping hazards and other clutter.
- Do not allow the hose to remain pressurized when not in service. Turning off the pressure can provide dramatic increases in steam hose service life.
- The best protection from accidents is the anticipation that they could occur.

 **WARNING:** Failure to properly follow the manufacturer's recommended procedures for the care, maintenance and storage of a particular hose may result in its failure to perform in the manner intended and may result in serious injury, death, and damage to property.

Periodic Maintenance of Steam Hose Can Pay Big Dividends

All steam hoses are expected to wear out in time. It is important to continually be on the look-out for hose that has deteriorated to the point where it can no longer provide safe service. The following guidelines can help in that determination.

Operators should be aware of the obvious signs of trouble. They include:

- Steam leakages at the coupling ends or anywhere along the length of the hose.
 - Flattened or kinked areas which have damaged the hose.
- When any of the above abnormalities appear, it is good safety sense to immediately remove the hose from service. Once removed, the hose can be carefully inspected before further use.
- PTFE is not recommended for steam-cold water cycling.

 **WARNING:** Only specially trained persons should engage in applications or testing procedures that require particular skills. Failure to do so may result in damage to the hose products or to other property and more importantly, may also result in serious injury.

Application Data

Steam Temperatures

Temperatures of Saturated Steam at Various Pressures

LBS. PER SQ IN. PRESSURE	DEGREES FAHRENHEIT	DEGREES CENTIGRADE	LBS. PER SQ IN. PRESSURE	DEGREES FAHRENHEIT	DEGREES CENTIGRADE
0	212.0	100.0	110	344.1	173.4
5	227.1	108.4	115	347.2	175.1
10	239.4	115.2	120	350.1	176.7
15	249.8	121.0	125	352.9	178.3
20	258.8	126.0	130	355.6	179.8
22	261.2	127.8	135	358.3	181.3
24	265.3	129.6	140	360.9	182.7
26	268.3	131.3	145	363.4	184.1
28	271.2	132.9	150	365.9	185.5
30	274.1	134.5	155	368.2	186.8
32	276.8	136.0	160	370.6	188.1
34	279.3	137.4	165	373.9	189.4
36	281.8	138.8	170	375.3	190.7
38	284.4	140.2	175	377.4	191.9
40	286.7	141.5	180	379.6	193.1
42	289.0	142.8	185	381.7	194.3
44	291.2	144.0	190	383.7	195.4
46	293.5	145.3	195	385.9	196.6
48	295.5	146.4	200	387.9	197.7
50	297.7	147.6	205	398.8	198.8
52	299.9	148.7	210	391.6	199.8
54	301.6	149.8	215	392.9	200.5
56	303.6	150.9	220	395.4	201.7
58	305.4	151.9	225	397.2	202.9
60	307.4	153.0	230	399.0	203.9
62	309.2	154.0	235	400.7	204.8
64	310.8	154.9	240	402.5	205.8
66	312.6	155.9	245	404.2	206.8
68	314.2	156.8	250	406.1	207.8
70	316.0	157.0	255	407.7	208.7
72	317.7	158.7	260	409.4	209.7
74	319.3	159.6	265	411.0	210.6
76	320.9	160.5	270	412.6	211.4
78	322.3	161.3	275	414.2	212.3
80	323.8	162.1	280	415.7	213.2
85	327.6	164.2	300	421.0	216.1
90	331.2	166.2	350	436.5	224.7
95	334.6	168.1			
100	337.8	169.9			
105	341.1	171.7			



WARNING Steam heat is hotter than 212° F (boiling water) and increases in temperature as pressure increases. See safety information on page 4.

Application Data

Diverse and Demanding Applications



PTFE hose has excellent temperature characteristics. It works well in high ambient, fluid or gas media temperatures (+450°F). It works equally well in cryogenic applications (-65°F). Specific temperature guidelines are found on pages 9-14.

PTFE hose has a broad range of chemical resistance. It is inert to most commercial chemicals, acids, alcohols, coolants, elastomers, petroleum compounds, solvents, vinyls, synthetic lubricants, and hydraulic fluids. Chemical resistance guidelines are found on pages 60-65.

PTFE hose withstands continuous flexing, vibration, or impulse.

PTFE hose is compatible with steam. It absorbs no moisture hot or cold. It is easy to clean and sterilize.

PTFE hose is non-contaminating. Conveyed materials, fluids, or gases will not contaminate in service.

PTFE hose used in cold and hot cycling can cause the tube to crack.

PTFE hose has high flow rates. Its low coefficient of friction with anti-stick properties insures continuous lower pressure drop during service with good pressure rating.

PTFE hose resists deterioration. It is impervious to weather and can be stored for long periods of time without aging.

PTFE hose has a long life expectancy when applied within its temperature and pressure rating

PTFE hose handles many substances such as adhesives, asphalt, dyes, greases, glue, latex, lacquers & paints. It has no carbon build-up when used as a compressor discharge line.

Application Data

Hose Ordering Instructions and Hose Packaging Specifications

How To Order:

1. Specify quantity required:

- a. For bulk hose in random lengths, state quantity in feet. Example: 150 ft. S-12.
- b. For specified ("cut") lengths of hose, state number of pieces. Example: 10 pcs. S-12-00200.
- c. Eaton reserves the right to ship + 10% of the maximum reel length quantity or bulk quantity ordered.

2. Specify part number:

- a. For bulk hose, state hose style number and dash size. Example: 100 ft. S-12.
- b. For cut lengths, state hose style number and dash size plus length to the nearest 1/8 inch. Example:
10 pcs. S-12-00125 indicates 10 pieces S-12 hose, length of each piece 12-5/8 inches (the fifth digit of the length designator represents eighths of an inch).

3. Bulk PTFE hose is supplied in the following length patterns:

Sizes:

- 3 through -12
 - 75% in lengths 25 ft. or longer,
 - 25% in lengths 5 ft.-24 ft.
- 14 through -24
 - 65% in lengths 25 ft. or longer,
 - 35% in lengths 5 ft.-25 ft.

4. For large quantities of long lengths, please consult your Everflex product line source for price and availability information.

Note: Length tolerance for cut hose lengths, assemblies and sleeves is:

- Up to and including 12 inches: +/- 1/8"
- Above 12 inches to and including 18 inches: +/- 3/16"
- Above 18 inches to and including 36 inches: +/- 1/4"
- Above 36 inches: +/- 1% of length

Application Data

Hose Length Information

Average Length Patterns of PTFE Hose

PART NUMBER	MINIMUM LENGTH	AVERAGE LENGTH	MAXIMUM LENGTH
	Feet	Feet	Feet
S-3, SC-3	5	125	300
S-4, S-4TW, SC-4TW, SC-4, FC807-04	5	180	300
S-5, S-5TW, SC-5TW, SC-5, FC807-05	5	133	200
S-6, S-6TW, SC-6TW, SC-6, FC807-06	5	88	200
S-8, S-8TW, SC-8TW, SC-8, FC807-08	5	60	200
S-10, S-10TW, SC-10TW, SC-10, FC807-10	5	105	200
S-12, S-12TW, SC-12TW, SC-12, FC807-12	5	73	100
S-16, S-16TW, SC-16TW, SC-16, FC807-16	5	26	70
8012	5	22	30
8016	5	28	50
8020	5	36	60
8024	5	33	50
8032	5	25	30
8512	5	22	30
8516	5	36	50
8520	5	36	60
8524	5	33	50
8532	5	25	30

Smooth Bore PTFE Hose

Everflex Smooth Bore PTFE hose is specified in many of the most difficult applications in industry. The extruded tube has excellent flex life, high temperature resistance and chemical resistance. Additionally, since PTFE is steam compatible and non-adhesive, Everflex hose is an excellent choice in applications requiring steam cleaning of an assembly or transfer of a highly viscous media, such as adhesives, paints or food

products. The 304 stainless steel wire reinforcement/cover provides the strength necessary to carry the working pressure and the durability to withstand harsh environments. High temperature hydraulic and pneumatic systems, like those found in steel mills, foundries, transit buses and air compressors, are ideal locations to offer Everflex hose as a problem solver.

Smooth Bore "S" Series



Everflex S Series tube is reinforced with 304 stainless steel wire. All sizes have a minimum of .040" thick extruded virgin PTFE. That is 33% more PTFE

than most other manufacturers offer. The additional PTFE results in improved bend radius, kink resistance and slows permeation of gases.

Radius in inches to inside bend. Multiply bend radius by 1.25 for dynamic applications.

Braid:
Stainless Steel

Sizes:
5/32" I.D. to 1-1/8" I.D.

Temperature range:
-65° F to + 450° F
(-54°C to +230°C)

CATALOG NUMBER	ACTUAL I.D. (IN.)	AVE. O.D. (IN.)	WALL THICKNESS (IN.)	WORKING PRESSURE (PSI)	MIN. BURST PRESSURE (PSI)	MIN. BEND RADIUS	VACUUM SERVICE (INCH/HG)	HOSE ENDS
S-3	5/32	.250	.040	3,500	14,000	1.0	28	Everswage
S-4	3/16	.320	.040	3,000	12,000	1.5	28	Everswage
S-5	1/4	.375	.040	3,000	12,000	2.0	28	Everswage
S-6	5/16	.435	.040	2,500	10,000	3.5	28‡	Everswage
S-8	13/32	.565	.043	2,000	8,000	4.5	28‡	Everswage
S-10*	1/2	.656	.047	1,750	7,000	5.0	28‡	Everswage
S-12*	5/8	.780	.047	1,500	6,000	6.0	28‡	Everswage
S-16	7/8	1.050	.047	1,000	4,000	9.0	12‡	Everswage
S-16Z◇	7/8	1.100	.047	1,250	5,000	7.3	12‡	Everswage
S-20Z◇	1 1/8	1.350	.050	1,000	4,000	11.0	12‡	Everswage

⚠ WARNING: These hoses can be used to convey hazardous chemicals, steam, hot liquids or other dangerous materials which can cause death, serious bodily injury including burns, pressure wounds or chemical exposure if released accidentally. They should, therefore, only be handled or worked on by personnel properly trained in the safe handling of the materials or chemicals conveyed in the hoses.

◇ "Z" Designates a double braid of 304 stainless steel wire.

* The operating pressure of 1/2" I.D. hoses are lowered to 1500psi and 5/8" I.D. hoses are lowered to 1250 psi when Brass Everswage fittings are used.

‡ Maximum negative pressure for -16 and larger are suitable for hose which has suffered no external damage or kinking. If greater negative pressures are required for -16 and larger hoses, the use of an internal support coil is recommended. Use of an internal support coil in -06 and larger PTFE hose is recommended for tube support where extended or continuous service at high temperature together with low or negative pressure is expected.

Smooth Bore PTFE Hose

Smooth Bore "B" Series



Braid:
Bronze

Sizes:
5/32" I.D. to 7/8" I.D.

Everflex B Series is reinforced with bronze wire. All sizes have a minimum of 0.040" thick extended virgin PTFE.

Everflex B Series hose has traditionally been used in high vibration environments.

CATALOG NUMBER	ACTUAL I.D. (IN.)	AVE. O.D. (IN.)	WALL THICKNESS (IN.)	WORKING PRESSURE (PSI)	MIN. BURST PRESSURE (PSI)	MIN. BEND RADIUS	HOSE ENDS
B-4	3/16	.320	.040	1,250	5,000	1.5	Everswage
B-5	1/4	.375	.040	1,125	4,500	2.0	Everswage
B-6	5/16	.435	.040	1,050	4,200	3.5	Everswage
B-8	13/32	.565	.043	1,000	4,000	4.5	Everswage
B-10	1/2	.656	.047	900	3,600	5.0	Everswage
B-12	5/8	.780	.047	750	3,000	6.0	Everswage
B-16	7/8	1.050	.047	625	2,500	9.0	Everswage

Temperature range:
-65° F to + 400° F
(-54°C to +204°C)

Smooth Bore "STW" Series



Braid:
Stainless Steel

Sizes:
3/16" I.D. to 1" I.D.

Everflex STW Series tube is reinforced with 304 stainless steel wire. STW hose is available as an alternative

where competitors' thin wall products are specified and S Series hose can not be substituted. Radius in inches to

inside bend. Multiply bend radius by 1.25 for dynamic applications.

CATALOG NUMBER	ACTUAL I.D. (IN.)	AVE. O.D. (IN.)	WALL THICKNESS (IN.)	WORKING PRESSURE (PSI)	MIN. BURST PRESSURE (PSI)	MIN. BEND RADIUS	VACUUM SERVICE (INCH/HG)	HOSE ENDS
S-4TW	3/16	.305	.030	3,000	12,000	2.0	28	Everswage, Field Attachable, 'E' Series
S-5TW	1/4	.375	.030	3,000	12,000	3.0	28	Everswage, Field Attachable, 'E' Series
S-6TW	5/16	.430	.030	2,500	10,000	4.0	28‡	Everswage, Field Attachable, 'E' Series
S-7TW	3/8	.515	.030	2,000	8,000	5.0	28‡	'E' Series
S-8TW	13/32	.535	.030	2,000	8,000	5.0	28‡	Everswage, Field Attachable
S-10TW*	1/2	.636	.030	1,750	7,000	6.5	28‡	Everswage, Field Attachable, 'E' Series
S-12TW*	5/8	.765	.030	1,500	6,000	7.5	28‡	Everswage, Field Attachable
S-14TW	3/4	.890	.035	1,000	4,000	8.5	28‡	'E' Series
S-16TW	7/8	1.030	.035	1,000	4,000	9.0	12‡	Everswage, Field Attachable
S-18ZTW◇	1	1.215	.035	1,000	4,000	12.0	12‡	'E' Series

⚠ WARNING: These hoses can be used to convey hazardous chemicals, steam, hot liquids or other dangerous materials which can cause death, serious bodily injury including burns, pressure wounds or chemical exposure if released accidentally. They should, therefore, only be handled or worked on by personnel properly trained in the safe handling of the materials or chemicals conveyed in the hoses.

◇ "Z" Designates a double braid of 304 stainless steel wire.

* The operating pressure of 1/2" I.D. hoses are lowered to 1500psi and 5/8" I.D. hoses are lowered to 1250 psi when Brass Everswage fittings are used.

‡ Maximum negative pressure for -16 and larger are suitable for hose which has suffered no external damage or kinking. If greater negative pressures are required for -16 and larger hoses, the use of an internal support coil is recommended. Use of an internal support coil in -06 and larger PTFE hose is recommended for tube support where extended or continuous service at high temperature together with low or negative pressure is expected.

Smooth Bore PTFE Hose

Smooth Bore "FC807" Series



Braid:
Stainless Steel with Nomex
Tracer yarn

Sizes:
3/16" I.D. to 7/8" I.D.

Temperature range:
-100° F to + 450° F
(-73°C to +230°C)

FC807 hose is a competi-
tively-priced, smooth bore
PTFE hose reinforced with
304 stainless steel wire.
FC807 is a general purpose

PTFE product that incorpo-
rates a red Nomex** Tracer
yarn in the stainless steel
outer braid.

CATALOG NUMBER	ACTUAL I.D. (IN.)	AVE. O.D. (IN.)	WALL THICKNESS (IN.)	WORKING PRESSURE (PSI)	MIN. BEND RADIUS	MIN. BURST PRESSURE (PSI)	VACUUM SERVICE (INCH/HG)	HOSE ENDS
FC807-04	0.190	0.300	0.030	3000	2.00	12,000	28	Everswage, Field Attachable, 'E' Series
FC807-05	0.260	0.370	0.030	3000	3.00	12,000	28	Everswage, Field Attachable, 'E' Series
FC807-06	0.320	0.430	0.030	2500	4.00	10,000	28‡	Everswage, Field Attachable, 'E' Series
FC807-08	0.420	0.540	0.030	2000	5.25	8,000	28‡	Everswage, Field Attachable
FC807-10	0.510	0.630	0.030	1500	6.50	6,000	28‡	Field Attachable
FC807-12*	0.640	0.760	0.030	1200	7.75	5,000	28‡	Everswage, Field Attachable
FC807-16	0.880	1.03	0.030	1000	9.00	4,000	12‡	Field Attachable

Smooth Bore "S-3" Series Hose



Braid:
Stainless Steel

Size:
5/32" I.D.

Temperature range:
-40° F to + 200° F
(-40°C to +93°C)

S-3 with a PVC cover is a
PTFE hose which can be
used for DOT 571.106
hydraulic brake line applica-
tions. PVC cover is on the
exterior in 0.020" thickness.

The PVC cover is useful to
protect motorcycle paint
jobs or provide durability in
an abrasive environment.

CATALOG NUMBER	ACTUAL I.D. (IN.)	AVE. O.D. (IN.)	WALL THICKNESS (IN.)	WORKING PRESSURE (PSI)	MIN. BURST PRESSURE (PSI)	MIN. BEND RADIUS	HOSE ENDS
S-3-.020CLPVC	5/32	0.290	0.040	3500	14,000	1.0	Everswage***

Please contact Eaton in regard to hose assemblies. Colored PVC covers and printing options may be available.

⚠ WARNING: These hoses can be used to convey hazardous chemicals, steam, hot liquids or other dangerous materials which can cause death, serious bodily injury including burns, pressure wounds or chemical exposure if released accidentally. They should, therefore, only be handled or worked on by personnel properly trained in the safe handling of the materials or chemicals conveyed in the hoses.

* The operating pressure of 1/2" I.D. hoses are lowered to 1500psi and 5/8" I.D. hoses are lowered to 1250 psi when Brass Everswage fittings are used.

** Nomex is a trademark of E.I. DuPont.

*** Cover must be removed from hose where fitting is attached.

‡ Maximum negative pressure for -16 and larger are suitable for hose which has suffered no external damage or kinking. If greater negative pressures are required for -16 and larger hoses, the use of an internal support coil is recommended. Use of an internal support coil in -06 and larger PTFE hose is recommended for tube support where extended or continuous service at high temperature together with low or negative pressure is expected.

Smooth Bore PTFE Hose

Smooth Bore "SC" Series**



Braid: Stainless Steel

Sizes: 5/32" I.D. to 7/8" I.D.

Temperature range:

-65° F to + 450° F
(-54°C to +230°C)

SC Series hose is identical to the S series with one exception. SC hose has an internal conductive static dissipating tube that

provides a path to the hose end fittings for applications where flow induced electrostatic charges can occur. Radius in inches to inside

bend. Multiply bend radius by 1.25 for dynamic applications.

CATALOG NUMBER	ACTUAL I.D. (IN.)	AVE. O.D. (IN.)	WALL THICKNESS (IN.)	WORKING PRESSURE (PSI)	MIN. BURST PRESSURE (PSI)	MIN. BEND RADIUS	VACUUM SERVICE (INCH/HG)	HOSE ENDS
SC-3	5/32	.250	.040	3,500	14,000	1.0	28	Everswage
SC-4	3/16	.320	.040	3,000	12,000	1.5	28	Everswage
SC-5	1/4	.375	.040	3,000	12,000	2.0	28	Everswage
SC-6	5/16	.435	.040	2,500	10,000	3.5	28‡	Everswage
SC-8	13/32	.565	.043	2,000	8,000	4.5	28‡	Everswage
SC-10*	1/2	.656	.047	1,750	7,000	5.0	28‡	Everswage
SC-12*	5/8	.780	.047	1,500	6,000	6.0	28‡	Everswage
SC-16	7/8	1.050	.047	1,000	4,000	9.0	12‡	Everswage

Smooth Bore "SCTW" Series**



Braid:
Stainless Steel

Sizes:
5/32" I.D. to 1" I.D.

Temperature range:

-65° F to + 450° F
(-54°C to +230°C)

SCTW Series hose is identical to the STW Series with one exception. SCTW hose has an internal conductive static dissipating tube that

provides a path to the hose end fittings for applications where flow induced electrostatic charges can occur. Radius in inches to

inside bend. Multiply bend radius by 1.25 for dynamic applications.

CATALOG NUMBER	ACTUAL I.D. (IN.)	AVE. O.D. (IN.)	WALL THICKNESS (IN.)	WORKING PRESSURE (PSI)	MIN. BURST PRESSURE (PSI)	MIN. BEND RADIUS	VACUUM SERVICE (INCH/HG)	HOSE ENDS
SC-4TW	3/16	.305	.030	3,000	12,000	2.0	28	Everswage, Field Attachable, 'E' Series
SC-5TW	1/4	.375	.030	3,000	12,000	3.0	28	Everswage, Field Attachable, 'E' Series
SC-6TW	5/16	.430	.030	2,500	10,000	4.0	28‡	Everswage, Field Attachable, 'E' Series
SC-7TW	3/8	.515	.030	2,000	8,000	5.0	28‡	'E' Series
SC-8TW	13/32	.535	.030	2,000	8,000	5.0	28‡	Everswage, Field Attachable
SC-10TW*	1/2	.636	.030	1,750	7,000	6.5	28‡	Everswage, Field Attachable, 'E' Series
SC-12TW*	5/8	.765	.030	1,500	6,000	7.5	28‡	Everswage, Field Attachable
SC-14TW	3/4	.890	.035	1,000	4,000	8.5	28‡	'E' Series
SC-16TW	7/8	1.030	.035	1,000	4,000	9.0	12‡	Everswage, Field Attachable
SC-18ZTW◇1		1.215	.035	1,000	4,000	12.0	12‡	'E' Series

** Carbon black used meets the requirements of 21CFR178.3297 for FDA compliance.



WARNING: These hoses can be used to convey hazardous chemicals, steam, hot liquids or other dangerous materials which can cause death, serious bodily injury including burns, pressure wounds or chemical exposure if released accidentally. They should, therefore, only be handled or worked on by personnel properly trained in the safe handling of the materials or chemicals conveyed in the hoses.

* The operating pressure of 1/2" I.D. hoses are lowered to 1500psi and 5/8" I.D. hoses are lowered to 1250 psi when Brass Everswage fittings are used.

◇ "Z" Designates a double braid of 304 stainless steel wire.

‡ Maximum negative pressure for -16 and larger are suitable for hose which has suffered no external damage or kinking. If greater negative pressures are required for -16 and larger hoses, the use of an internal support coil is recommended. Use of an internal support coil in -06 and larger PTFE hose is recommended for tube support where extended or continuous service at high temperature together with low or negative pressure is expected.

Smooth Bore PTFE Hose

Smooth Bore "Hi-PSI" Series



Braid:
Stainless Steel

Sizes:
0.220" I.D. to 1.375" I.D.

Temperature range:
-65° F to + 400° F
(-54°C to +204°C)

Hi-PSI Series hose is a heavy wall PTFE hose for very high pressure applications. The reinforcement is braided and not spiraled

allowing for better hose flexibility.

CATALOG NUMBER	ACTUAL I.D. (IN.)	AVE. O.D. (IN.)	WORKING PRESSURE (PSI)	WORKING PRESSURE AT 400' (PSI)	MIN. BURST PRESSURE (PSI)	MIN. BEND RADIUS
H504	0.220	0.375	5,000	2,000	16,000	1.5
H506	0.313	0.485	5,000	2,000	16,000	2.5
H508	0.406	0.615	5,000	2,000	16,000	2.9
H510	0.500	0.740	5,000	2,000	16,000	3.3
H512	0.625	0.970	5,000	2,000	16,000	4.0
H516	0.875	1.295	5,000	2,000	16,000	5.0
H520	1.125	1.600	5,000	2,000	16,000	12.0
H524	1.375	1.850	4,000	2,000	12,000	14.0

Hoses must be assembled by Eaton. Standard Stainless Steel JIC fittings are available. Maximum assembly length is 25 feet in sizes -12 and above. In sizes -4 thru -10, assembly lengths can exceed 25 feet.

HOSE/TUBE SIZE	INSERT PART NUMBER	COLLAR PART NUMBER	FEMALE JIC THREAD SIZE	HOSE ASSEMBLY PART NUMBER
-4	H20004-4-316/4	H70000-4-304	7/16-20	FK4650EEE-Length
-6	H20006-6-316/4	H70000-6-304	9/16-18	FK4650GGG-Length
-8	H20008-8-316/4	H70000-8-304	3/4-16	FK4650HHH-Length
-10	H20010-10-316/4	H70000-10-304	7/8-14	FK4650JJJ-Length
-12	H20012-12-316/4	H70000-12-304	1-1/16-12	FK4650KKK-Length
-16	H20016-16-316/4	H70000-16-304	1-5/16-12	FK4650MMM-Length
-20	H20020-20-316/4	H70000-20-304	1-5/8-12	FK4650NNN-Length
-24	H20024-24-316/4	H70000-24-304	1-7/8-12	FK4650PPP-Length

Smooth Bore PTFE Hose

Hose Ends Everswage

For use with PTFE Hoses
FC807, STW, SCTW, B, S, SC

Everswage hose ends are permanently attached to Everflex Smooth Bore PTFE hose using a swaging process. The unique design of the Everswage collar allows a hose assembly fabricator to slide several collars at once on the hose. This significantly reduces the time required to fabricate an assembly. The most popular industrial fitting configurations, male pipe (NPT) and female JIC (SAE) swivels, are available in 300 Series stainless steel, carbon steel, or brass. Consult factory for availability of 316 stainless steel wetted parts.



Part Number Example:
B-1104-1
B = Brass
C = Carbon Steel
S = Stainless Steel

Note: The operating pressure of 1/2" I.D. hoses are lowered to 1500psi and 5/8" I.D. hoses are lowered to 1250 psi when Brass Everswage fittings are used.

Male Pipe (NPT)

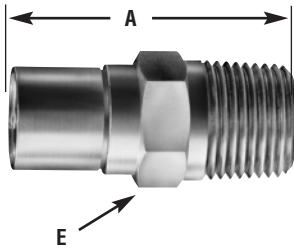

HOSE I.D.	PART NO. PRE-FIX LETTER	CATALOG NUMBER	PIPE SIZE	THREAD SIZE	A	HOSE CUT-OFF FACTOR†	E
5/32	B,S	1103	1/8	1/8-27	1.19	3/4	1/2
3/16	B,C,S	1104-1	1/8	1/8-27	1.34	3/4	1/2
3/16	B,C,S	1104-2	1/4	1/4-18	1.47	7/8	9/16
1/4	B,C,S	1105	1/4	1/4-18	1.47	7/8	9/16
1/4	B	1105-1/8	1/8	1/8	1.34	15/16	9/16
5/16	B,C,S	1106-1	1/4	1/4-18	1.47	7/8	11/16
5/16	B,C,S	1106-2	3/8	3/8-18	1.53	15/16	11/16
5/16	B,S	1106-3	1/2	1/2	1.75	1-1/8	7/8
13/32	B,C,S	1108-1	3/8	3/8-18	1.84	1	3/4
13/32	B,C,S	1108-2	1/2	1/2-14	1.97	1-1/8	7/8
1/2	B,C,S	1110	1/2	1/2-14	1.97	1-3/16	7/8
5/8	B,C,S	1112	3/4	3/4-14	2.14	1-5/16	1-1/16
7/8	B,C,S	1116	1	1-11.5	2.94	1-5/8	1-3/8
7/8	B,C,S	1116Z‡	1	1-11.5	2.94	1-5/8	1-3/8
1-1/8	B,C,S	1120Z‡	1-1/4	1-1/4-11.5	3.03	1-3/4	1-3/4

! WARNING: Selection of the proper end fitting for the hose end application is essential to the proper operation and safe use of the hose and related equipment. Inadequate attention to the selection of the end fittings for your application can result in leaking or the hose end blowing off the hose, leading to serious personal injury, death or property damage.

† To determine the correct length of hose, subtract the cut-off factor for each end fitting from the overall length of assembly.

‡ The 16Z, 18ZTW, and 20Z sizes have a double stainless steel wire reinforcement.

Smooth Bore PTFE Hose

Hose Ends Everswage

For use with PTFE Hoses
FC807, STW, SCTW, B, S, SC

37° JIC Swivel

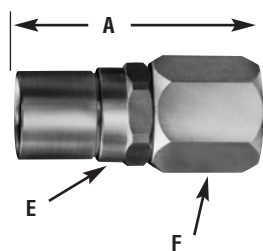

HOSE I.D.	PART NO. PRE-FIX LETTER	CATALOG NUMBER	TUBE SIZE	THREAD SIZE	A	HOSE CUT-OFF FACTOR†	E	F
5/32	B,S	1303	3/16	3/8-24	1.38	0.85		1/2
5/32	B	1303-4	1/4	7/16-20	1.38	0.90	1/2	9/16
3/16	B,C,S	1304	1/4	7/16-20	1.50	0.90	1/2	9/16
1/4	B,C,S	1305	5/16	1/2-20	1.63	0.94	9/16	5/8
5/16	B,C,S	1306	3/8	9/16-18	1.63	0.99	5/8	11/16
13/32	B,C,S	1308	1/2	3/4-16	2.00	1.18	3/4	7/8
1/2	B,C,S	1310	5/8	7/8-14	2.00	1.30	7/8	1
5/8	B,C,S	1312	3/4	1-1/6-12	2.25	1.38	1-1/16	1-1/4
7/8	B,C,S	1316	1	1-5/16-12	2.88	1.51	1-3/8	1-1/2
7/8	B,C,S	1316Z‡	1	1-5/16-12	2.88	1.51	1-3/8	1-1/2
1-1/8	B,C,S	1320Z‡	1-1/4	1-5/8-12	3.13	1.26	1-3/4	2

45° Brass Swivel

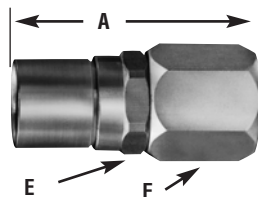

HOSE I.D.	CATALOG NUMBER	TUBE SIZE	THREAD SIZE	A	HOSE CUT-OFF FACTOR†	E	F
3/16	Fitt. #30	1/4	7/16-20	1.50	0.90	1/2	9/16
1/4	Fitt. #31	5/16	1/2-20	1.50	0.94	9/16	5/8
5/16	Fitt. #32	3/8	5/8-18	1.63	0.96	5/8	3/4
13/32	Fitt. #33	1/2	3/4-16	2.00	1.18	3/4	7/8
1/2	Fitt. #34	5/8	7/8-14	2.13	1.30	7/8	1
5/8	Fitt. #35▲	3/4	1-1/16-14	2.25	1.38	1-1/16	1-1/4

! WARNING: Selection of the proper end fitting for the hose end application is essential to the proper operation and safe use of the hose and related equipment. Inadequate attention to the selection of the end fittings for your application can result in leaking or the hose end blowing off the hose, leading to serious personal injury, death or property damage.

† To determine the correct length of hose, subtract the cut-off factor for each end fitting from the overall length of assembly.

▲ Only fitting 35 has Carbon Steel nut.

‡ The 16Z, 18ZTW, and 20Z sizes have a double stainless steel wire reinforcement.

Smooth Bore PTFE Hose

Hose Ends Everswage

For use with PTFE Hoses
FC807, STW, SCTW, B, S, SC

Female Pipe (NPT)

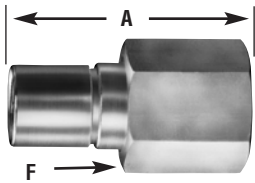

HOSE I.D.	PART NO. PRE-FIX LETTER	CATALOG NUMBER	PIPE SIZE	THREAD SIZE	A	HOSE CUT-OFF FACTOR†	F
3/16	B	2104-1	1/8	1/8-27	1.28	11/16	9/16
3/16	B	2104-2	1/4	1/4-18	1.41	13/16	3/4
1/4	B,S	2105	1/4	1/4-18	1.41	13/16	3/4

Stainless Steel Tube Stub

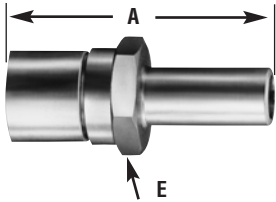

HOSE I.D.	CATALOG NUMBER	TUBE SIZE	CONNECTOR	A	HOSE CUT-OFF FACTOR†	E
3/16	STE4-4	1/4" O.D.	0.188	1.50	1-1/8	9/16
1/4	STE4-5	1/4" O.D.	0.203	1.50	7/8	9/16
5/16	STE6-6	3/8" O.D.	0.266	1.63	1	11/16
13/32	STE8-8	1/2" O.D.	0.359	2.25	1-3/8	7/8
5/8	STE12-12	3/4" O.D.	0.578	2.38	1-1/2	1-1/16
7/8	STE16-16	1" O.D.	0.813	3.00	1-11/16	1-3/8

Brass Laundry Flange



(Flange is plated carbon steel, copper gasket included)

HOSE I.D.	CATALOG NUMBER	NOMINAL I.D.	A	HOSE CUT-OFF FACTOR†
	B-6LFC	17/64	1	5/16

Brass Tire Mold Flange



(Flange is plated carbon steel)

HOSE I.D.	CATALOG NUMBER	NOMINAL I.D.	A	HOSE CUT-OFF FACTOR†	E
5/8	FITT. #60	37/64	2.63	1-5/8	1-1/16
7/8	FITT. #62	13/16	2.50	1-11/16	1-3/8



WARNING: Selection of the proper end fitting for the hose end application is essential to the proper operation and safe use of the hose and related equipment. Inadequate attention to the selection of the end fittings for your application can result in leaking or the hose end blowing off the hose, leading to serious personal injury, death or property damage.

† To determine the correct length of hose, subtract the cut-off factor for each end fitting from the overall length of assembly.

Smooth Bore PTFE Hose

Hose Ends Everswage

For use with PTFE Hoses
FC807, STW, SCTW, B, S, SC

Carbon Steel Paint Spray Swivel

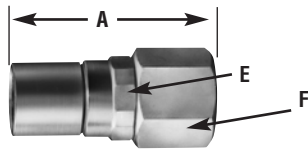

HOSE I.D.	CATALOG NUMBER	THREAD SIZE	A	HOSE CUT-OFF FACTOR†	E	F
1/4	C-5PS	1/4 NPSM	1.50	0.82	9/16	5/8

SAE Brass Male Compression

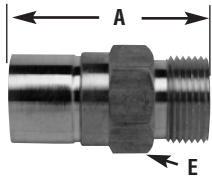

HOSE I.D.	CATALOG NUMBER	PIPE SIZE	THREAD SIZE	A	HOSE CUT-OFF FACTOR†	E
1/2	FITT. #40	5/8	13/16-18	1.75	29/32	7/8

SAE Brass Female Compression

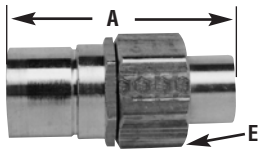

HOSE I.D.	CATALOG NUMBER	PIPE SIZE	THREAD SIZE	A	HOSE CUT-OFF FACTOR†	E
1/2	FITT. #41	5/8	13/16-18	2.00	1-3/16	15/16

Stainless Steel Power Trim, Straight

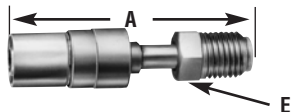

(316 Stainless Steel wetted Parts.)

HOSE I.D.	CATALOG NUMBER	TUBE SIZE	THREAD SIZE	A	HOSE CUT-OFF FACTOR†	E
3/16	PT-S-4	3/16	3/8-24	1.88	1-7/16	3/8

! WARNING: Selection of the proper end fitting for the hose end application is essential to the proper operation and safe use of the hose and related equipment. Inadequate attention to the selection of the end fittings for your application can result in leaking or the hose end blowing off the hose, leading to serious personal injury, death or property damage.

† To determine the correct length of hose, subtract the cut-off factor for each end fitting from the overall length of assembly.

Smooth Bore PTFE Hose

Hose Ends Everswage

For use with PTFE Hoses
FC807, STW, SCTW, B, S, SC

Stainless Steel Power Trim, 45° Elbow

HOSE I.D.	CATALOG NUMBER	TUBE SIZE	THREAD SIZE	A	HOSE CUT-OFF FACTOR†	B	E
3/16	PT-45-4	3/16	3/8-24	2.75	2	3/4	3/8

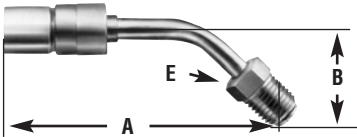

(316 Stainless Steel wetted parts.)

Stainless Steel Power Trim, 90° Elbow

HOSE I.D.	CATALOG NUMBER	TUBE SIZE	THREAD SIZE	A	HOSE CUT-OFF FACTOR†	B	E
3/16	PT-90-4	3/16	3/8-24	2.00	1-1/2	1	3/8

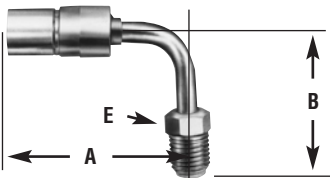

(316 Stainless Steel wetted parts.)

Sanitary Tri Clamp

HOSE I.D.	CATALOG NUMBER	G	NOMINAL I.D.	A	HOSE CUT-OFF FACTOR†	D
1/2	10-S.37-316	.375	.45	1.5	.6875	.985
7/8	16-S.87-316	.86	.81	2.0	.6875	1.984

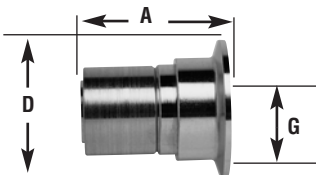

(316 Stainless Steel wetted parts.)

! WARNING: Selection of the proper end fitting for the hose end application is essential to the proper operation and safe use of the hose and related equipment. Inadequate attention to the selection of the end fittings for your application can result in leaking or the hose end blowing off the hose, leading to serious personal injury, death or property damage.

† To determine the correct length of hose, subtract the cut-off factor for each end fitting from the overall length of assembly.

Smooth Bore PTFE Hose

Components Everswage

For use with PTFE Hoses
FC807, STW, SCTW, B, S, SC

Male Pipe Insert



HOSE I.D.	CATALOG NUMBER	PART NO. SUFFIX LETTER	PIPE SIZE
3/16	NM2-4	B,C,S	1/8
3/16	NM4-4	B,C,S	1/4
1/4	NM4-5	B,C,S	5/16
5/16	NM4-6	B,C,S	1/4
5/16	NM6-6	B,C,S	3/8
13/32	NM6-8	B,C,S	3/8
13/32	NM8-8	B,C,S	1/2
1/2	NM8-10	B,C,S	1/2
5/8	NM12-12	B,C,S	1
7/8	NM16-16	B,C,S	1
1-1/8	NM20-20	B,C,S	1-1/4

Swage Collars



HOSE I.D.	CATALOG NUMBER	PART NO. SUFFIX LETTER	JIC SIZE
3/16	NC-4	B,C,S	1/4
1/4	NC-5	B,C,S	5/16
5/16	NC-6	B,C,S	3/8
13/32	NC-8	B,C,S	1/2
1/2	NC-10	B,C,S	5/8
5/8	NC-12	B,C,S	3/4
7/8	NC-16	B,C,S	1
7/8	NC-16Z	B,C,S	1
1-1/8	NC-20Z	B,C,S	1-1/4

37° JIC Female Nuts



HOSE I.D.	CATALOG NUMBER	PART NO. SUFFIX LETTER	JIC SIZE
3/16	NNJ-4	B,C,S	1/4
1/4	NNJ-5	B,C,S	5/16
5/16	NNJ-6	B,C,S	3/8
13/32	NNJ-8	B,C,S	1/2
1/2	NNJ-10	B,C,S	5/8
5/8	NNJ-12	B,C,S	3/4
7/8	NNJ-16	B,C,S	1
1-1/8	NNJ-20	B,C,S	1-1/4



WARNING: Selection of the proper end fitting for the hose end application is essential to the proper operation and safe use of the hose and related equipment. Inadequate attention to the selection of the end fittings for your application can result in leaking or the hose end blowing off the hose, leading to serious personal injury, death or property damage.

Smooth Bore PTFE Hose

Components Everswage

For use with PTFE Hoses
FC807, STW, SCTW, B, S, SC

37° JIC Female Insert



HOSE I.D.	CATALOG NUMBER	PART NO. SUFFIX LETTER	JIC SIZE
3/16	NJ-4	C,S	1/4
1/4	NJ-5	B,C,S	5/16
5/16	NJ-6	B,C,S	3/8
13/32	NJ-8	B,C,S	1/2
1/2	NJ-10	B,C,S	5/8
5/8	NJ-12	B,C,S	3/4
7/8	NJ-16	B,C,S	1
1-1/8	NJ-20	B,C,S	1-1/4

37° JIC Female Short Collars



HOSE I.D.	CATALOG NUMBER	PART NO. SUFFIX LETTER	JIC SIZE
3/16	NJC-4	B,C,S	1/4
1/4	NJC-5	B,C,S	5/16
5/16	NJC-6	B,C,S	3/8
13/32	NJC-8	B,C,S	1/2
1/2	NJC-10	B,C,S	5/8
5/8	NJC-12	B,C,S	3/4
7/8	NJC-16	B,C,S	1
1-1/8	NJC-20	B,C,S	1-1/4



WARNING: Selection of the proper end fitting for the hose end application is essential to the proper operation and safe use of the hose and related equipment. Inadequate attention to the selection of the end fittings for your application can result in leaking or the hose end blowing off the hose, leading to serious personal injury, death or property damage.

Smooth Bore PTFE Hose

Everswage
Fittings For Use
As a Conduit
Shielding

Everswage Fitting



HOSE I.D.	CATALOG NUMBER	INSERT CATALOG NUMBER	COLLAR CATALOG NUMBER	A	HOSE CUT-OFF FACTOR†
5/16	BE-5/16	BE-5/16-I	BE-5/16-C	0.63	0.25
5/16	SE-5/16	SE-5/16-I	SE-5/16-C	0.63	0.25
5/8	BE-12	BE-12-I	BE-12-C	0.75	11/32
5/8	SE-12	SE-12-1	SE-12-C	0.75	11/32

⚠ WARNING: Selection of the proper end fitting for the hose end application is essential to the proper operation and safe use of the hose and related equipment. Inadequate attention to the selection of the end fittings for your application can result in leaking or the hose end blowing off the hose, leading to serious personal injury, death or property damage.

† To determine the correct length of hose, subtract the cut-off factor for each end fitting from the overall length of assembly.

Smooth Bore PTFE Hose

Everswage Fitting Bill of Material Cross Reference

TOP ASSEMBLY CATALOG NUMBER	INSERT PART NUMBER	COLLAR PART NUMBER
B-1112	NM12-12-B	NC-12-B
C-1112	NM12-12-C	NC-12-C
S-1112	NM12-12-S	NC-12-S
B-1116	NM16-16-B	NC-16-B
C-1116	NM16-16-C	NC-16-C
S-1116	NM16-16-S	NC-16-S
B-1103	NM2-3-B	NC-3-B
S-1103	NM2-3-S	NC-3-S
B-1104-1	NM2-4-B	NC-4-B
C-1104-1	NM2-4-C	NC-4-C
S-1104-1	NM2-4-S	NC-4-S
B-1105-1/8	NM2-5-B	NC-5-B
B-1116Z	NM16-16-B	NC-16Z-B
C-1116Z	NM16-16-C	NC-16Z-C
S-1116Z	NM16-16S	NC-16Z-S
B-1120Z	NM20-20-B	NC-20Z-B
C-1120Z	NM20-20-C	NC-20Z-C
S-1120Z	NM20-20-S	NC-20Z-S
B-1104-2	NM4-4-B	NC-4-B
C-1104-2	NM4-4-C	NC-4-C
S-1104-2	NM4-4-S	NC-4-S
B-1105	NM4-5-B	NC-5-B
C-1105	NM4-5-C	NC-5-C
S-1105	NM4-5-S	NC-5-S
B-1106-1	NM4-6-B	NC-6-B
C-1106-1	NM4-6-C	NC-6-C
S-1106-1	NM4-6-S	NC-6-S
B-1106-2	NM6-6-B	NC-6-B
C-1106-2	NM6-6-C	NC-6-C
S-1106-2	NM6-6-S	NC-6-S
B-1108-1	NM6-8-B	NC-8-B
C-1108-1	NM6-8-C	NC-8-C
S-1108-1	NM6-8-S	NC-8-S
B-1110	NM8-10-B	NC-10-B
C-1110	NM8-10-C	NC-10-C
S-1110	NM8-10-S	NC-10-S
B-1106-3	NM8-6-B	NC-6-B
C-1106-3	NM8-6-C	NC-6-C
S-1106-3	NM8-6-S	NC-6-S
B-1108-2	NM8-8-B	NC-8-B
C-1108-2	NM8-8-C	NC-8-C
S-1108-2	NM8-8-S	NC-8-S
C-5PS	NPS-5-C	NC-5-C
Fitt. #30	NSAE-4-B	NC-4-B
Fitt. #32	NSAE-6-B	NC-6-B
Fitt. #33	NSAE-8-B	NC-8-B
Fitt. #34	NSAE-10-B	NC-10-B
Fitt. #35	NSAE-12-B	NC-12-B

TOP ASSEMBLY CATALOG NUMBER	INSERT PART NUMBER	COLLAR PART NUMBER
B-1303	NJIC-3-B	NC-3-B
S-1303	NJIC-3-S	NC-3-S
B-1303-4	NJIC4-3-B	NC-3-B
S-1303-4	NJIC4-3-S	NC-3-S
B-1304	NJICSAE-4-B	NC-4-B
C-1304	NJIC-4-C	NC-4-C
S-1304	NJIC-4-S	NC-4-S
B-1305	NJIC-5-B	NC-5-B
C-1305	NJIC-5-C	NC-5-C
S-1305	NJIC-5-S	NC-5-S
B-1306	NJIC-6-B	NC-6-B
C-1306	NJIC-6-C	NC-6-C
S-1306	NJIC-6-S	NC-6-S
B-1308	NJIC-8-B	NC-8-B
C-1308	NJIC-8-C	NC-8-C
S-1308	NJIC-8-S	NC-8-S
B-1310	NJIC-10-B	NC-10-B
C-1310	NJIC-10-C	NC-10-C
S-1310	NJIC-10-S	NC-10-S
B-1312	NJIC-12-B	NC-12-B
C-1312	NJIC-12-C	NC-12-C
S-1312	NJIC-12-S	NC-12-S
B-1316	NJIC-16-B	NC-16-B
C-1316	NJIC-16-C	NC-16-C
S-1316	NJIC-16-S	NC-16-S
B-1316Z	NJIC-16-B	NC-16Z-B
C-1316Z	NJIC-16-C	NC-16Z-C
S-1316Z	NJIC-16-S	NC-16Z-S
B-1320Z	NJIC-20-B	NC-20Z-B
C-1320Z	NJIC-20-C	NC-20Z-C
S-1320Z	NJIC-20-S	NC-20Z-S
B-2104-1	NF2-4-B	NC-4-B
B-2104-2	NF4-4-B	NC-4-B
B-2105	NF4-5-B	NC-5-B
S-2105	NF4-5-S	NC-5-S
FITT. #40	NMC-10-B	NC-10-B
PT-S-4	NPTS-4-S	NC-4-S
PT-45-4	NPT45-4-S	NC-4-S
PT-90-4	NPT90-4-S	NC-4-S

Smooth Bore PTFE Hose

Hose Ends 'E' Series Crimp

For use with PTFE Hoses
FC807, STW, SCTW

E Series hose ends are permanently attached to Everflex smooth bore PTFE hose using a crimping process. These one-piece hose ends eliminate the need for handling inserts and collars separately which reduces assembly fabrication time. The wide variety of carbon steel end configurations, including 45 and 90 degree elbows, open opportunities in applications where hose assembly routing space is very tight, such as transit buses and many high temperature hydraulic setups. 'E' SERIES FITTINGS ARE AVAILABLE FOR SPECIFIC SIZES OF 0.030" WALL HOSE ONLY.

Male Pipe Rigid

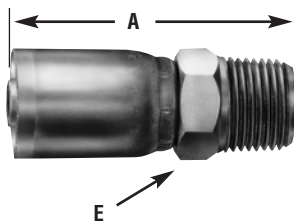

HOSE I.D.	CATALOG NUMBER	PIPE SIZE	THREAD SIZE	A	HOSE CUT-OFF FACTOR†	HOLE DIA.	HEX E
3/16	03E-102	1/8	1/8-27	1.58	3/4	.09	7/16
3/16	03E-104	1/4	1/4-18	1.83	1	.09	9/16
1/4	04E-102	1/8	1/8-27	1.61	7/8	.16	7/16
1/4	04E-104	1/4	1/4-18	1.79	1	.16	9/16
1/4	04E-106	3/8	3/8-18	1.83	1	.16	11/16
5/16	05E-104	1/4	1/4-18	1.87	1	.22	9/16
5/16	05E-106	3/8	3/8-18	1.89	1	.22	11/16
3/8	06E-104	1/4	1/4-18	1.89	1	.27	9/16
3/8	06E-106	3/8	3/8-18	1.92	1	.27	11/16
3/8	06E-108	1/2	1/2-14	2.17	1-1/4	.27	7/8
1/2	08E-106	3/8	3/8-18	2.02	1	.38	3/4
1/2	08E-108	1/2	1/2-14	2.27	1-1/4	.38	7/8
3/4	12E-112	3/4	3/4-14	2.51	1-5/16	.61	1-1/16
1	16E-116	1	1-11-1/2	2.95	1-5/8	.84	1-3/8



WARNING: Selection of the proper end fitting for the hose end application is essential to the proper operation and safe use of the hose and related equipment. Inadequate attention to the selection of the end fittings for your application can result in leaking or the hose end blowing off the hose, leading to serious personal injury, death or property damage.

† To determine the correct length of hose, subtract the cut-off factor for each end fitting from the overall length of assembly.

Smooth Bore PTFE Hose

Hose Ends 'E' Series Crimp

For use with PTFE Hoses
FC807, STW, SCTW

Male Pipe Swivel

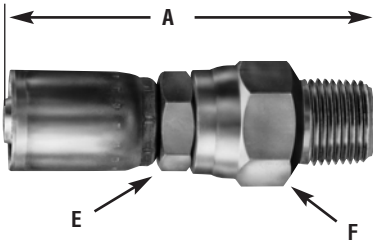

HOSE I.D.	CATALOG NUMBER	PIPE SIZE	THREAD SIZE	A	HOSE CUT-OFF FACTOR†	HOLE DIA.	HEX E	HEX F
1/4	04E-J04	1/4	1/4-18	2.68	1-7/8	.16	5/8	13/16
5/16	05E-J04	1/4	1/4-18	2.74	1-7/8	.22	5/8	13/16
3/8	06E-J06	3/8	3/8-18	2.79	1-13/16	.27	11/16	7/8
1/2	08E-J08	1/2	1/2-14	3.03	2-1/16	.38	3/4	7/8
3/4	12E-J12	3/4	3/4-14	3.73	2-9/16	.61	1-1/4	1-1/4

(Not for temperatures above 212°F with nitrile o-rings.)

SAE 37° (JIC) Male Rigid

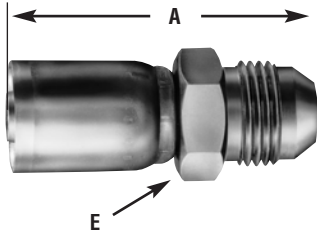

HOSE I.D.	CATALOG NUMBER	TUBE SIZE	THREAD SIZE	A	HOSE CUT-OFF FACTOR†	HOLE DIA.	HEX E
1/4	04E-504	1/4	7/16-20	1.78	15/16	.16	1/2
1/4	04E-505	5/16	1/2-20	1.78	15/16	.16	9/16
1/4	04E-506	3/8	9/16-18	1.82	1	.16	5/8
5/16	05E-505	5/16	1/2-20	1.86	1	.22	9/16
3/8	06E-506	3/8	9/16-18	1.92	1	.27	5/8
3/8	06E-508	1/2	3/4-16	2.08	13/16	.27	13/16
1/2	08E-508	1/2	3/4-16	2.18	13/16	.38	13/16
1/2	08E-510	5/8	7/8-14	2.31	1-1/4	.38	15/16
3/4	12E-512	3/4	1-1/16-12	2.63	1-7/16	.61	1-1/8
1	16E-516	1	1-5/16-12	2.83	1-1/2	.84	1-3/8

Inverted Male Swivel Straight

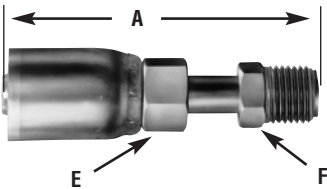

HOSE I.D.	CATALOG NUMBER	PIPE SIZE	THREAD SIZE	A	HOSE CUT-OFF FACTOR†	HOLE DIA.	HEX E	HEX F
1/4	04E-B03	3/16	3/8-24	3.06	2-3/16	.12	7/16	3/8
1/4	04E-B04	1/4	7/16-24	2.44	1-5/8	.15	7/16	7/16
1/4	04E-B05	5/16	1/2-20	3.71	2-7/8	.21	7/16	1/2
3/8	06E-B05	5/16	1/2-20	2.56	1-9/16	.21	9/16	1/2
3/8	06E-B06	3/8	5/8-18	2.18	1-13/16	.24	5/8	5/8
1/2	08E-B08	1/2	3/4-18	3.14	2-1/16	.33	3/4	3/4

⚠ WARNING: Selection of the proper end fitting for the hose end application is essential to the proper operation and safe use of the hose and related equipment. Inadequate attention to the selection of the end fittings for your application can result in leaking or the hose end blowing off the hose, leading to serious personal injury, death or property damage.

† To determine the correct length of hose, subtract the cut-off factor for each end fitting from the overall length of assembly.

Smooth Bore PTFE Hose

Hose Ends 'E' Series Crimp

For use with PTFE Hoses
FC807, STW, SCTW

Air Brake Connection - Tube

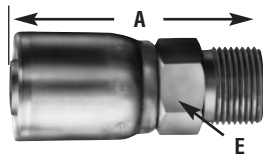

HOSE I.D.	CATALOG NUMBER	PIPE SIZE	THREAD SIZE	A	HOSE CUT-OFF FACTOR†	HOLE DIA.	HEX E
1/2	08E-Y58	1/2	11/16-20	2.12	1-1/16	.38	3/4
1/2	08E-Y60	5/8	13/16-18	2.18	1-1/8	.38	7/8
3/4	12E-Y60	5/8	13/16-18	2.33	1-1/8	.61	1
3/4	12E-Y62	3/4	1-18	2.40	1-3/16	.61	1

Flareless Tube Rigid

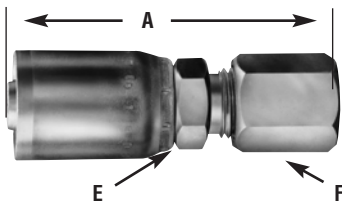

HOSE I.D.	CATALOG NUMBER	PIPE SIZE	THREAD SIZE	A	HOSE CUT-OFF FACTOR†	HOLE DIA.	HEX E	HEX F
5/16	05E-756	3/8	9/16-18	1.88	1	.22	5/8	11/16
3/8	06E-755	5/16	1/2-20	1.78	7/8	.23	9/16	5/8
3/8	06E-756	3/8	9/16-18	1.82	15/16	.27	5/8	11/16
1/2	08E-758	1/2	3/4-16	2.08	1-1/16	.38	13/16	7/8

SAE 37° (JIC) Female Swivel

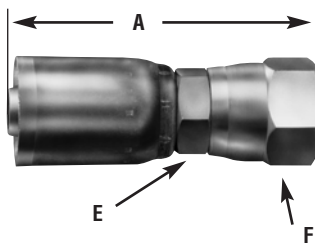

HOSE I.D.	CATALOG NUMBER	PIPE SIZE	THREAD SIZE	A	HOSE CUT-OFF FACTOR†	HOLE DIA.	HEX E	HEX F
3/16	03E-604 ¹	1/4	7/16-20	1.89	1-1/32	.09	7/16	9/16
1/4	04E-604 ¹	1/4	7/16-20	1.92	1-1/8	.16	7/16	9/16
1/4	04E-605 ¹	5/16	1/2-20	2.00	1-3/16	.16	1/2	5/8
1/4	04E-606 ¹	3/8	9/16-18	2.05	1-1/4	.16	9/16	11/16
5/16	05E-605 ¹	5/16	1/2-20	2.07	1-3/16	.22	1/2	5/8
5/16	05E-406 ²	3/8	5/8-18	2.06	1-1/8	.22	9/16	3/4
5/16	05E-606 ³	3/8	9/16-18	2.15	1-1/4	.22	9/16	11/16
3/8	06E-406 ²	3/8	5/8-18	2.06	1-1/8	.27	9/16	3/4
3/8	06E-606 ³	3/8	9/16-18	2.19	1-1/4	.27	9/16	11/16
3/8	06E-608 ¹	1/2	3/4-16	2.30	1-3/8	.27	3/4	7/8
1/2	08E-608 ¹	1/2	3/4-16	2.45	1-1/2	.38	3/4	7/8
1/2	08E-610 ¹	5/8	7/8-14	2.56	1-1/2	.38	7/8	1
3/4	12E-412 ²	3/4	1-1/16-14	2.98	1-11/16	.61	1-1/8	1-3/8
3/4	12E-612 ³	3/4	1-1/16-12	2.75	1-9/16	.61	1	1-1/4
1	16E-616 ³	1	1-5/16-12	3.08	1-3/4	.84	1-1/4	1-1/2

⚠ WARNING: Selection of the proper end fitting for the hose end application is essential to the proper operation and safe use of the hose and related equipment. Inadequate attention to the selection of the end fittings for your application can result in leaking or the hose end blowing off the hose, leading to serious personal injury, death or property damage.

† To determine the correct length of hose, subtract the cut-off factor for each end fitting from the overall length of assembly.

1- Swivel nuts are universal- Both SAE 45° and JIC 37° connections, 2- SAE 45° flare connection only,

3- JIC 37° flare connection only

Smooth Bore PTFE Hose

Hose Ends 'E' Series Crimp

For use with PTFE Hoses
FC807, STW, SCTW

British Standard (BSPP) 60° Cone Female Pipe Swivel

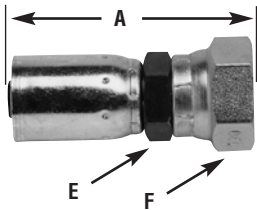

HOSE I.D.	CATALOG NUMBER	PIPE SIZE	THREAD SIZE	A	HOSE CUT-OFF FACTOR†	HOLE DIA.	HEX E	HEX F
3/16	03E-354	1/4	G-1/4-19 •	2.01	1-1/32	.16	9/16	11/16
1/4	04E-354	1/4	G-1/4-19 •	1.88	1-1/32	.16	9/16	11/16
3/8	06E-356	3/8	G-3/8-19 •	2.09	1-1/8	.27	3/4	7/8
3/8	06E-358	1/2	G-1/2-14 •	2.47	1-1/2	.27	13/16	1
1/2	08E-358	1/2	G-1/2-14 •	2.56	1-1/2	.39	13/16	1
1/2	08E-360	5/8	G-5/8-14 •	2.70	1-21/32	.39	7/8	1-3/16
3/4	12E-362	3/4	G-3/4-14 •	2.94	19/32	.61	1	1-1/4
1	16E-366	1	G-1-11 •	3.38	2-1/32	.84	1-1/4	1-1/2

Female Swivel JIS 30° Flare

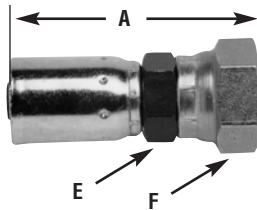

HOSE I.D.	CATALOG NUMBER	TUBE SIZE	THREAD SIZE	A	HOSE CUT-OFF FACTOR†	HOLE DIA.	HEX E	HEX F
1/4	04E-04L	1/4	1/4-19	1.83	1	.16	9/16	3/4
3/8	06E-06L	3/8	3/8-19	2.07	1-1/8	.27	11/16	7/8
1/2	08E-08L	1/2	1/2-14	2.03	1-1/4	.39	13/16	1-1/16
3/4	12E-12L	3/4	3/4-14	2.75	1-17/32	.61	1	1-5/16
1	16E-16L	1	1-11	3.05	1-23/32	.84	1-1/4	1-5/8

Female For-Seal® Swivel Straight

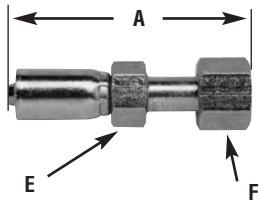

HOSE I.D.	CATALOG NUMBER	THREAD SIZE	A	HOSE CUT-OFF FACTOR†	HOLE DIA.	HEX E	HEX F
1/4	04E-S64	9/16-18	2.14	1-15/16	.15	5/8	11/16
1/4	04E-S66	11/16-16	2.20	1-3/8	.16	5/8	13/16
5/16	05E-S66	11/16-16	2.28	1-3/8	.22	9/16	13/16
3/8	06E-S66	11/16-16	2.37	1-7/16	.24	9/16	13/16
3/8	06E-S68	13/16-16	2.65	1-11/16	.24	5/8	15/16
1/2	08E-S68	13/16-16	2.74	1-11/16	.33	3/4	15/16
1/2	08E-S70	1-14	2.83	1-13/16	.39	3/4	1-1/8
3/4	12E-S72	1-3/16-12	2.98	1-3/4	.59	1	1-3/8
1	16E-S76	1-7/16-12	3.31	2	.76	1-1/4	1-5/8

WARNING: Selection of the proper end fitting for the hose end application is essential to the proper operation and safe use of the hose and related equipment. Inadequate attention to the selection of the end fittings for your application can result in leaking or the hose end blowing off the hose, leading to serious personal injury, death or property damage.

† To determine the correct length of hose, subtract the cut-off factor for each end fitting from the overall length of assembly.

• G in thread size is ISO designation for parallel thread.

Smooth Bore PTFE Hose

Hose Ends 'E' Series Crimp

For use with PTFE Hoses
FC807, STW, SCTW

Straight Tube Brass

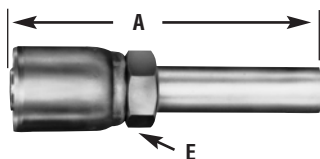

HOSE I.D.	CATALOG NUMBER	PIPE SIZE	THREAD SIZE	A	HOSE CUT-OFF FACTOR†	HOLE DIA.	HEX E
1/2	08E-T58	1/2	11/16-20	2.12	1-1/16	.38	3/4
1/2	08E-T60	5/8	13/16-18	2.18	1-1/8	.38	7/8
3/4	12E-T60	5/8	13/16-18	2.33	1-1/8	.53	1
3/4	12E-T62	3/4	1-18	2.40	1-13/16	.61	1

Sleeve - Nut

TUBE I.D.	CATALOG NUMBER SLEEVE	CATALOG NUMBER NUT
3/8	1360X6	1361X6
1/2	1360X8	1361X8
5/8	1360X10	1361X10
3/4	1360X12	1361X12

Compressor Discharge Flange End - GM Bus Only

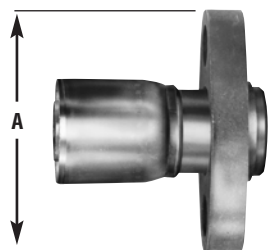

HOSE I.D.	CATALOG NUMBER	A	HOSE CUT-OFF FACTOR†	HOLE DIA.
3/4	12E-X92	2.64	1-3/8	.61

Inverted Male Swivel 45° Tube Elbow

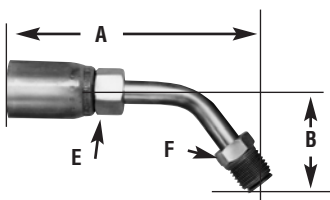

HOSE I.D.	CATALOG NUMBER	PIPE SIZE	THREAD SIZE	A	B	HOSE CUT-OFF FACTOR†	HOLE DIA.	HEX E	HEX F
1/4	04E-B43	3/16	3/8-24	2.79	.69	1-5/16	.12	7/16	3/8
1/4	04E-B44	1/4	7/16-24	2.74	.93	1-15/16	.15	7/16	7/16
3/8	06E-B45	5/16	1/2-20	3.37	1.14	2-7/16	.21	9/16	1/2
3/8	06E-B46	3/8	5/8-18	3.63	1.34	2-11/16	.24	5/8	5/8
1/2	08E-B48	1/2	3/4-18	4.32	1.58	3-1/4	.33	3/4	3/4

WARNING: Selection of the proper end fitting for the hose end application is essential to the proper operation and safe use of the hose and related equipment. Inadequate attention to the selection of the end fittings for your application can result in leaking or the hose end blowing off the hose, leading to serious personal injury, death or property damage.

† To determine the correct length of hose, subtract the cut-off factor for each end fitting from the overall length of assembly.

Smooth Bore PTFE Hose

Hose Ends 'E' Series Crimp

For use with PTFE Hoses
FC807, STW, SCTW

SAE 37° (JIC) Female Swivel 45° Tube Elbow

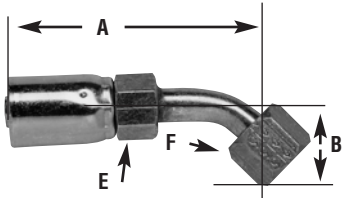

HOSE I.D.	CATALOG NUMBER	PIPE SIZE	THREAD SIZE	A	B	HOSE CUT-OFF FACTOR†	HOLE DIA.	HEX E	HEX F
1/4	04E-684 ¹	1/4	7/16-20	2.37	.33	1-9/16	.15	7/16	9/16
1/4	04E-685 ¹	5/16	1/2-20	2.50	.36	1-5/8	.16	7/16	5/8
5/16	05E-686 ³	3/8	9/16-18	2.65	.39	1-11/16	.22	9/16	11/16
3/8	06E-686 ³	3/8	9/16-18	2.74	.39	1-3/4	.24	5/8	11/16
3/8	06E-688 ¹	1/2	3/4-16	2.99	.55	2	.27	5/8	7/8
1/2	08E-688 ¹	1/2	3/4-16	3.08	.55	2	.33	3/4	1
1/2	08E-690 ¹	5/8	7/8-12	3.28	.63	2-1/4	.37	3/4	1
3/4	12E-692 ³	3/4	1-1/16-12	3.69	.78	2-7/16	.58	1	1-1/4
1	16E-696 ³	1	1-5/16-12	4.09	.89	2-3/4	.84	1-1/4	1-1/2

Female For-Seal® Swivel 45° Tube Elbow

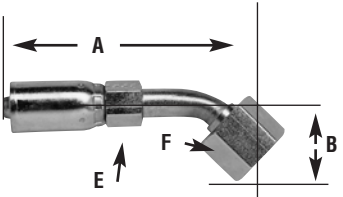

HOSE I.D.	CATALOG NUMBER	THREAD SIZE	A	B	HOSE CUT-OFF FACTOR†	HOLE DIA.	HEX E	HEX F
1/4	04E-L64	9/16-18	2.46	.41	1-5/8	.15	7/16	11/16
3/8	04E-L66	11/16-16	2.69	.43	1-3/4	.15	5/8	13/16
3/8	06E-L66	11/16-16	2.79	.43	1-13/16	.24	5/8	13/16
1/2	08E-L68	13/16-16	3.14	.60	2-1/8	.33	3/4	15/16
3/4	12E-L72	1-3/16-12	3.38	.83	2-5/8	.59	1	1-3/8
1	16E-L76	1-7/16-12	4.31	.94	3	.76	1-1/4	1-5/8

Inverted Male Swivel 90° Tube Elbow

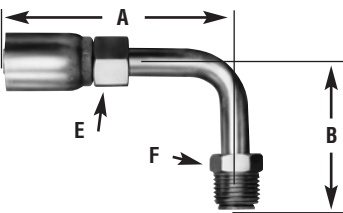

HOSE I.D.	CATALOG NUMBER	PIPE SIZE	THREAD SIZE	A	B	CUT-OFF FACTOR†	HOSE HOLE DIA.	HEX E	HEX F
1/4	04E-B63	3/16	3/8-24	2.16	1.06	1-5/16	.12	7/16	3/8
1/4	04E-B64	1/4	7/19-24	2.18	1.36	1-5/16	.15	7/16	7/16
3/8	06E-B65	5/16	1/2-20	2.58	1.16	1-5/8	.21	9/16	1/2
3/8	06E-B66	3/8	5/8-18	2.92	1.97	1-15/16	.24	5/8	5/8
1/2	08E-B68	1/2	3/4-18	3.03	2.32	1-15/16	.33	3/4	3/4



WARNING: Selection of the proper end fitting for the hose end application is essential to the proper operation and safe use of the hose and related equipment. Inadequate attention to the selection of the end fittings for your application can result in leaking or the hose end blowing off the hose, leading to serious personal injury, death or property damage.

† To determine the correct length of hose, subtract the cut-off factor for each end fitting from the overall length of assembly.

1- Swivel nuts are universal- Both SAE 45° and JIC 37° connections, 2- SAE 45° flare connection only,

3- JIC 37° flare connection only

Smooth Bore PTFE Hose

Hose Ends 'E' Series Crimp

For use with PTFE Hoses
FC807, STW, SCTW

SAE 37° (JIC) Female Swivel 90° Tube Elbow

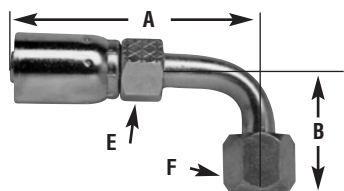

HOSE I.D.	CATALOG NUMBER	PIPE SIZE	THREAD SIZE	A	B	HOSE CUT-OFF FACTOR†	HOLE DIA.	HEX E	HEX F
1/4	04E-664 ¹	1/4	7/16-20	2.27	.68	1-7/16	.15	7/16	9/16
1/4	04E-665 ¹	5/16	1/2-20	2.51	.77	1-5/8	.16	7/16	5/8
5/16	05E-665 ¹	5/16	1/2-20	2.58	.77	1-5/8	.18	9/16	5/8
5/16	05E-666 ³	3/8	9/16-18	2.63	.85	1-11/16	.22	9/16	11/16
3/8	06E-466 ³	3/8	5/8-18	2.27	.85	1-3/4	.24	5/8	11/16
3/8	06E-666 ³	3/8	9/16-18	2.72	.85	1-3/4	.24	5/8	11/16
3/8	06E-668 ¹	1/2	3/4-16	2.83	1.09	1-3/4	.27	5/8	7/8
1/2	08E-668 ¹	1/2	3/4-16	2.93	1.09	1-7/8	.33	3/4	7/8
1/2	08E-670 ¹	5/8	7/8-14	3.54	1.23	1-7/8	.38	3/4	1
3/4	12E-672 ³	3/4	1-1/16-12 3.56	1.82	2-5/16	.58	1	1-1/4	
1	16E-676 ³	1	1-5/16-12 4.06	2.14	2-5/16	.84	1-1/4	1-1/2	

SAE 37° (JIC) Female Swivel Long Drop 90° Tube Elbow

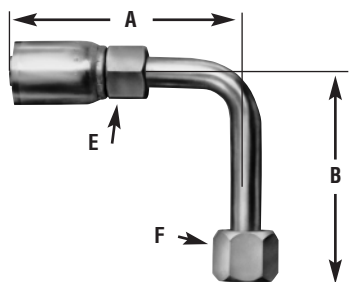

HOSE I.D.	CATALOG NUMBER	PIPE SIZE	THREAD SIZE	A	B	HOSE CUT-OFF FACTOR†	HOLE DIA.	HEX E	HEX F
1/4	04E-664 ¹	1/4	7/16-20	2.40	1.80	1-7/16	.15	7/16	9/16
1/4	04E-645 ¹	5/16	1/2-20	2.51	1.80	1-5/8	.16	7/16	5/8
5/16	05E-646 ³	3/8	9/16-18	2.63	2.18	1-11/16	.22	9/16	11/16
3/8	06E-646 ³	3/8	9/16-18	2.72	2.18	1-3/4	.24	5/8	11/16
3/8	06E-648 ¹	1/2	3/4-16	2.83	2.43	1-7/8	.27	5/8	11/16
1/2	08E-648 ¹	1/2	3/4-16	2.92	2.43	1-7/8	.33	3/4	7/8
1/2	08E-650 ¹	5/8	7/8-14	3.09	2.57	2-1/16	.38	3/4	1
1/2	12E-652 ³	5/8	1-1/16-12	3.60	3.60	2-3/8	.58	1	1-1/4
1	16E-656 ³	1	1-5/16-12	4.20	4.20	2-13/16	.84	1-1/4	1-1/2

Female For-Seal® Swivel Short Drop 90° Tube Elbow

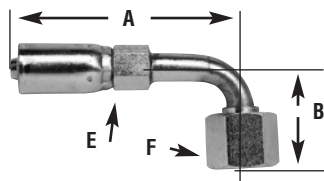

HOSE I.D.	CATALOG NUMBER	THREAD SIZE	A	B	HOSE CUT-OFF FACTOR†	HOLE DIA.	HEX E	HEX F
1/4	04E-A24	9/16-18	2.35	.81	1-1/2	.21	7/16	11/16
1/4	04E-A26	11/16-16	2.54	.90	1-11/16	.16	5/8	13/16
3/8	06E-A26	11/16-16	2.71	.90	1-3/4	.24	5/8	13/16
3/8	06E-A28	13/16-16	2.81	1.15	1-7/8	.27	5/8	15/16
1/2	08E-A28	13/16-16	2.90	1.15	1-7/8	.33	3/4	15/16
3/4	12E-A32	1-3/16-12	3.70	1.88	2-1/2	.59	1	1-3/8
1	16E-A36	1-7/16-12	4.11	2.21	2-3/4	.76	1-1/4	1-5/8

! WARNING: Selection of the proper end fitting for the hose end application is essential to the proper operation and safe use of the hose and related equipment. Inadequate attention to the selection of the end fittings for your application can result in leaking or the hose end blowing off the hose, leading to serious personal injury, death or property damage.

† To determine the correct length of hose, subtract the cut-off factor for each end fitting from the overall length of assembly.

1- Swivel nuts are universal- Both SAE 45° and JIC 37° connections, 2- SAE 45° flare connection only,

3- JIC 37° flare connection only

Smooth Bore PTFE Hose

Hose Ends 'E' Series Crimp

For use with PTFE Hoses
FC807, STW, SCTW

Female For-Seal Swivel Long Drop 90° Tube Elbow

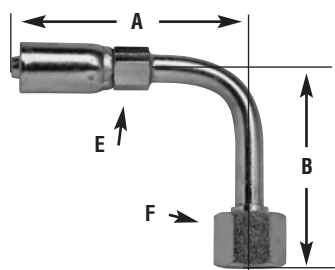

HOSE I.D.	CATALOG NUMBER	THREAD SIZE	A	B	HOSE CUT-OFF FACTOR†	HOLE DIA.	HEX E	HEX F
1/4	04E-A64	9/16-18	2.41	1.80	1-9/16	.21	7/16	11/16
5/16	05E-A66	11/16-18	2.73	2.12	1-13/16	.22	9/16	13/16
3/8	06E-A66	11/16-16	2.82	2.21	1-7/8	.24	5/8	13/16
3/8	06E-A68	13/16-16	2.80	2.50	1-7/8	.27	5/8	15/16
1/2	08E-A68	13/16-16	2.89	2.50	1-7/8	.33	3/4	15/16

British Standard (BSPP) 60° Cone Female Pipe Swivel 90° Elbow

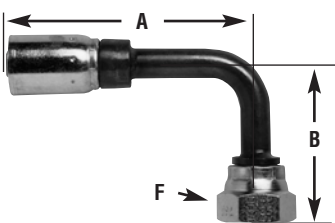

HOSE I.D.	CATALOG NUMBER	BSPP PIPE SIZE	THREAD SIZE	A	B	HOSE CUT-OFF FACTOR†	HOLE DIA.	HEX E	HEX F
1/4	04E-74P	1/4	G-1/4-19 •	2.81	1.45	1-13/16	.16	7/16	11/16
3/8	06E-76P	3/8	G-3/8-19 •	2.96	1.67	2	.27	5/8	7/8
1/2	08E-78P	1/2	G-1/2-14 •	2.95	1.73	1-29/32	.37	3/4	1-1/4
3/4	12E-82P	3/4	G-3/4-14 •	3.83	2.43	1-19/32	.61	1	1-1/4



WARNING: Selection of the proper end fitting for the hose end application is essential to the proper operation and safe use of the hose and related equipment. Inadequate attention to the selection of the end fittings for your application can result in leaking or the hose end blowing off the hose, leading to serious personal injury, death or property damage.

† To determine the correct length of hose, subtract the cut-off factor for each end fitting from the overall length of assembly.

• G in thread size is ISO designation for parallel thread.

Smooth Bore PTFE Hose

Field Attachable Fittings Cross Reference

Male Pipe Field Attachables for TW Hoses

OLD EVERFLEX PART NUMBER	NEW EVERFLEX PART NUMBER
F4T-102-B	38-190627-2-4
F4T-104-B	38-190627-4-4
F5T-104-B	38-190627-4-8
F6T-104-B	38-190627-4-10
F6T-106-B	38-190627-6-6
F8T-106-B	38-190627-6-8
F10T-108-B	38-190627-8-10
F12T-112-B	38-190627-12-12
F16T-116-B	38-190627-16-16

37° JIC (SAE) Female Field Attachables for TW Hoses

OLD EVERFLEX PART NUMBER	NEW EVERFLEX PART NUMBER
F4T-604-B	63-190600-4
F5T-605-B	63-190600-5
F6T-606-B	63-190600-6
F8T-608-B	63-190600-8
F10T-610-B	63-190600-10
F12T-612-B	63-190600-12
F16T-616-B	63-190600-16

Smooth Bore PTFE Hose

Part Number Example:
FC9063-0808S

S = Carbon Steel

Hose Fittings Field Attachable

For use with PTFE Hose
FC807, STW, SCTW

Male Pipe NPTF

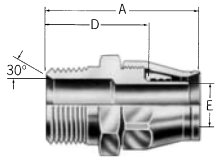

Part No. 38-190627-

CATALOG NUMBER	THREAD	HOSE I.D.	A	D	EØ
38-190627-					
2-4*	1/8-27	3/16	1.35	.89	.16
4-4*	1/4-18	3/16	1.54	1.08	.16
4-5*	1/4-18	1/4	1.58	1.07	.23
4-6*	1/4-18	5/16	1.66	1.13	.28
6-6*	3/8-18	5/16	1.66	1.13	.28
6-8*	3/8-18	13/32	1.79	1.16	.38
8-10*	1/2-14	1/2	2.13	1.46	.47
12-12*	3/4-14	5/8	2.26	1.61	.59
16-16*	1-11/2	7/8	2.48	1.86	.83

2-Bolt Swivel Flange

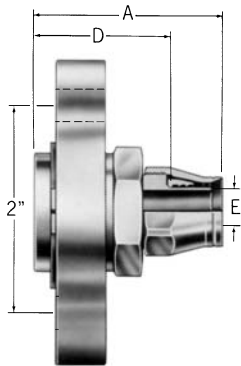

Part No. 63-190626

CATALOG NUMBER	FLANGE HEAD DIAMETER	HOSE I.D.	A	D	EØ
63-190626-					
6	2.88	5/16	1.78	1.26	.28
12	2.88	5/8	2.07	1.42	.56
16	2.88	7/8	2.18	1.49	.19

SAE Male Inverted Flare 45° Elbow

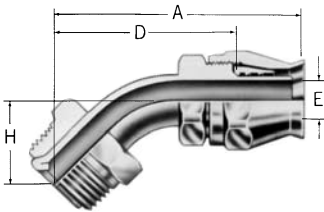

Part No. FC9063

CATALOG NUMBER	THREAD	HOSE I.D.	A	D	EØ	H
FC9063-						
0505S	1/2-20	1/4	2.46	1.94	.23	.96
0506S	1/2-20	5/16	2.50	1.97	.21	.96
0606S	5/8-18	5/16	2.50	1.97	.28	.96
0808S	3/4-18	13/32	2.66	2.04	.38	.93
1010S	7/8-18	1/2	2.96	2.29	.47	1.03
1212S	11/16-16	5/8	3.10	2.44	.59	1.10

* Also supplied in stainless steel. Add suffix "C" to part number and delete prefix "38".
Example part number for stainless steel is 190627-4-5C.

Smooth Bore PTFE Hose

Part Number Example:
FC9063-0808S

S = Carbon Steel

Hose Fittings Field Attachable

For use with PTFE Hose
FC807, STW, SCTW

SAE 37° (JIC) Swivel

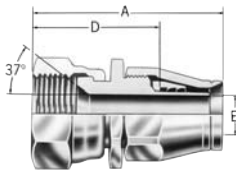

Part No. 63-190600-

CATALOG NUMBER	THREAD	HOSE I.D.	A	D	EØ
63-190600-					
4*	7/16-20	3/16	1.58	1.13	.16
5*	1/2-20	1/4	1.68	1.17	.23
6*	9/16-18	5/16	1.74	1.22	.26
8*	3/4-16	13/32	1.98	1.35	.38
10*	7/8-14	1/2	2.22	1.54	.47
12*	1 1/16-12	5/8	2.33	1.67	.59
16*	1 5/16-12	7/8	2.52	1.91	.83

SAE Male Inverted Flare 90° Elbow

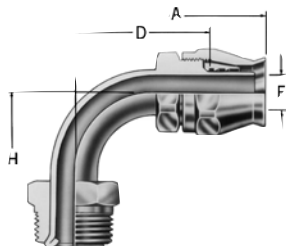

Part No. 190950-

CATALOG NUMBER	THREAD	HOSE I.D.	A	D	EØ	H
190950-						
4S	7/16-24	3/16	2.04	1.57	.16	1.69
5S	1/2-20	1/4	2.08	1.57	.23	1.69
5-6S	1/2-20	5/16	2.12	1.60	.21	1.69
6S	5/8-18	5/16	2.12	1.60	.28	1.73
8S	3/4-18	13/32	2.32	1.69	.38	1.74
10S	7/8-18	1/2	2.66	1.99	.47	2.21
12S	1 1/16-16	5/8	2.73	2.07	.59	2.35

SAE Ball Sleeve

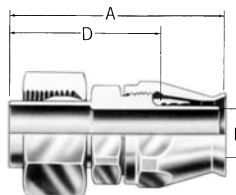

Part No. 190718-

CATALOG NUMBER	THREAD	HOSE I.D.	A	D	EØ
190718-					
8S	1 1/16-20	13/32	2.07	1.44	.38
10-8S	13/16-18	13/32	2.07	1.44	.38
10S	13/16-18	1/2	2.16	1.49	.48
12S	1-18	5/8	2.42	1.76	.59

* Also supplied in stainless steel. Add suffix "C" to part number and delete prefix "63".
Example part number for stainless steel is 190600-6C.

Smooth Bore PTFE Hose

Part Number Example:
FC9063-0808S

S = Carbon Steel

Hose Fittings Field Attachable

For use with PTFE Hose
FC807, STW, SCTW

Compression Ball Sleeve

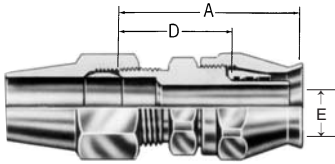

CATALOG NUMBER	HOSE I.D.	A	D	EØ
38-191074-				
8	13/32	1.66	1.04	.38
10	1/2	1.85	1.18	.47
12	5/8	2.08	1.41	.59

Part No. 38-191074-

SAE 45° Swivel

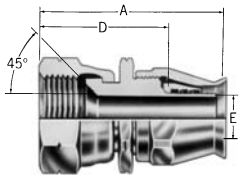

CATALOG NUMBER	THREAD	HOSE I.D.	A	D	EØ
63-190990-					
4	7/16-20	3/16	1.58	1.12	.16
5	1/2-20	1/4	1.68	1.17	.23
6	5/8-18	5/16	1.77	1.25	.28
8	3/4-16	13/32	1.98	1.36	.38
10	7/8-14	1/2	2.22	1.54	.47
12	1 1/16-14	5/8	2.33	1.67	.59

Part No. 63-190990-

45° Elbow

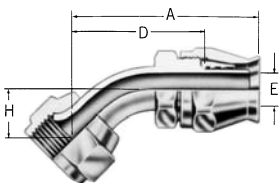

CATALOG NUMBER	THREAD	HOSE I.D.	A	D	EØ	H
190773-						
4S	7/16-20	3/16	1.51	1.05	.16	.33
5S	1/2-20	1/4	1.62	1.11	.23	.36
6S	9/16-18	5/16	1.72	1.20	.28	.39
8S	3/4-16	13/32	2.27	1.64	.38	.55
10S	7/8-14	1/2	2.46	1.79	.47	.64
12S	1 1/16-12	3/8	2.86	2.21	.59	.78
16S	1 5/16-12	7/8	3.30	2.68	.83	1.07
FC9341-						
0606S	5/8-18	5/16	1.72	1.20	.28	.39
1212S	1 1/16-14	5/8	2.86	2.21	.59	.78

Part Nos.

190773 - Universal
FC9341 - SAE 45° Swivel

Smooth Bore PTFE Hose

Part Number Example:
FC9063-0808S

S = Carbon Steel

Hose Fittings Field Attachable

For use with PTFE Hose
FC807, STW, SCTW

90° Elbow

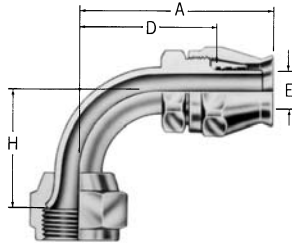

Part Nos.

190772 - Universal
FC9171 - SAE 45° Swivel

CATALOG NUMBER	THREAD	HOSE I.D.	A	D	EØ	H
190772-						
4S	7/16-20	3/16	1.41	.95	.16	.68
5S	1/2-20	1/4	1.52	1.00	.23	.77
6S	9/16-18	5/16	1.62	1.10	.28	.85
8S	3/4-16	13/32	2.03	1.41	.38	1.09
10S	7/8-14	1/2	2.16	1.49	.47	1.23
10-12S	7/8-14	5/8	2.23	1.57	.46	1.23
12S	11/16-12	5/8	2.82	2.17	.59	1.82
12-16S	11/16-14	7/8	2.87	2.22	.58	1.82
16S	15/16-12	7/8	3.10	2.49	.82	2.39
FC9171-						
0606S	5/8-18	5/16	1.62	1.10	.28	.85
1212S	11/16-14	5/8	2.80	2.19	.59	1.82

SAE Male Inverted Flare Straight

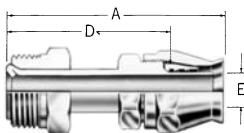

Part No. FC9062-

CATALOG NUMBER	THREAD	HOSE I.D.	A	D	EØ
FC9062-					
0404S	7/16-24	3/16	2.13	1.66	.16
0505S	1/2-20	1/4	2.17	1.66	.23
0506S	1/2-20	5/16	2.21	1.69	.21
0606S	5/8-18	5/16	2.21	1.69	.28
0808S	3/4-18	13/32	2.47	1.84	.38
1010S	7/8-18	1/2	2.78	2.11	.47
1212S	11/16-16	5/8	3.02	2.37	.59

Special Ball Sleeve

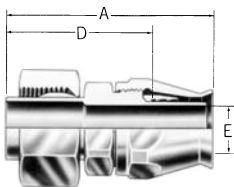

Part No. 190742-

CATALOG NUMBER	THREAD	HOSE I.D.	A	D	EØ
190742-					
10S	7/8-18	1/2	2.16	1.49	.48

Smooth Bore PTFE Hose

Hose and Fitting Cross Reference

EVERFLEX HOSE	FITTING QUALIFICATION
S-3	Everswage
S-4	Everswage
S-5	Everswage
S-6	Everswage
S-8	Everswage
S-10	Everswage
S-12	Everswage
S-16	Everswage
S-16Z	Everswage
S-20Z	Everswage
B-4	Everswage
B-5	Everswage
B-6	Everswage
B-8	Everswage
B-10	Everswage
B-12	Everswage
B-16	Everswage
S-4TW	Everswage, Field Attachable, & E-Series
S-5TW	Everswage, Field Attachable, & E-Series
S-6TW	Everswage, Field Attachable, & E-Series
S-7TW	E-Series
S-8TW	Everswage & Field Attachable
S-10TW	Everswage, Field Attachable, & E-Series
S-12TW	Everswage & Field Attachable
S-14TW	E-Series
S-16TW	Everswage & Field Attachable
S-18ZTW	E-Series
FC807-04	Everswage, Field Attachable, & E-Series
FC807-05	Everswage, Field Attachable, & E-Series
FC807-06	Everswage, Field Attachable, & E-Series
FC807-08	Everswage & Field Attachable
FC807-10	Field Attachable
FC807-12	Everswage & Field Attachable
FC807-16	Field Attachable
S-3-.020CLPVC	Everswage
SC-3	Everswage
SC-4	Everswage
SC-5	Everswage
SC-6	Everswage
SC-8	Everswage
SC-10	Everswage
SC-12	Everswage

EVERFLEX HOSE	FITTING QUALIFICATION
SC-16	Everswage
SC-4TW	Everswage, Field Attachable, & E-Series
SC-5TW	Everswage, Field Attachable, & E-Series
SC-6TW	Everswage, Field Attachable, & E-Series
SC-7TW	E-Series
SC-8TW	Everswage & Field Attachable
SC-10TW	Everswage, Field Attachable, & E-Series
SC-12TW	Everswage & Field Attachable
SC-14TW	E-Series
SC-16TW	Everswage & Field Attachable
SC-18ZTW	E-Series
H504	HI-PSI Fittings - Factory Crimp
H506	HI-PSI Fittings - Factory Crimp
H508	HI-PSI Fittings - Factory Crimp
H510	HI-PSI Fittings - Factory Crimp
H512	HI-PSI Fittings - Factory Crimp
H516	HI-PSI Fittings - Factory Crimp
H520	HI-PSI Fittings - Factory Crimp
H524	HI-PSI Fittings - Factory Crimp

Smooth Bore PTFE Hose

Accessories Everswage

Tubular Fire Sleeve



Operating temperatures:

Continuous:
-65° to +500°F

Intermittent:
-65° to +2000°F

Tested in accordance with:
UL-73, NFPA-250, ASTM-
E84

Everflex tubular firesleeve has a coating of specially compounded silicone rubber bonded to a low density, high bulk fiberglass sleeve. This combination offers a

temporary barrier to flame penetration and provides long term mechanical and environmental protection. Ideal applications include steel plants, foundries, glass

plants, and welding/cutting shops.

HOSE SIZE	HOSE I.D.	ASSEMBLY PART NUMBER
-4	3/16	SFS-1/2
-5	1/4	SFS-1/2
-6	5/16	SFS-11/16
-8	13/32	SFS-11/16
-10	1/2	SFS-11/16
-12	5/8	SFS-15/16
-16	7/8	SFS-1 1/4
-16Z‡	7/8	SFS-1 1/4
-20Z‡	1-1/8	SFS-1 1/2

Heat Shrinkable Chafe Sleeve



Operating temperature:

-65° to +275°F

Everflex heat shrink chafe sleeve is made of black flame retardant polyolefin. In addition to providing excellent chafe resistance, the sleeve can also be wiped

clean. This problem solver is ideal for any application where the assembly is subjected to abuse through abrasion.

HOSE SIZE	HOSE I.D.	ASSEMBLY PART NUMBER
-4	3/16	HSP-1/2
-5	1/4	HSP-1/2
-6	5/16	HSP-3/4
-8	13/32	HSP-5/8
-10	1/2	HSP-1
-12	5/8	HSP-1
-16	7/8	HSP-1 1/2
-16Z‡	7/8	HSP-1 1/2
-20Z‡	1-1/8	HSP-1 1/2

‡ The 16Z, and 20Z sizes have a double stainless steel wire reinforcement.

Smooth Bore PTFE Hose

Accessories Everswage

Spring Guard



Everflex spring guard is available in hot dipped galvanized carbon steel. This method of protection is well

suited for applications where rough handling, abrasion and severe flexing will occur.

HOSE SIZE	HOSE I.D.	ASSEMBLY PART NUMBER
-4	3/16	2004
-5	1/4	2005
-6	5/16	2006
-8	13/32	2008
-10	1/2	2010
-12	5/8	2012
-16	7/8	2016
-16Z†	7/8	2016Z
-20Z†	1-1/8	2020Z

Tight Pitch Spring Guard

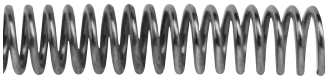

Everflex spring guard is available in hot dipped galvanized carbon steel. This method of protection is well

suited for applications where rough handling, abrasion and severe flexing will occur. Tight pitch spring

guard is widely accepted in maintenance applications on rubber tire manufacturing presses.

HOSE SIZE	HOSE I.D.	ASSEMBLY PART NUMBER
-4	3/16	2004T
-5	1/4	2005T
-6	5/16	2006T
-8	13/32	2008T
-10	1/2	2010T
-12	5/8	2012T
-16	7/8	2016T
-16Z†	7/8	2016ZT
-20Z†	1-1/8	2020ZT

302 Stainless Steel Internal Spring Guard



Everflex internal spring guard is available in 302 stainless steel.

HOSE SIZE	HOSE I.D.	ASSEMBLY PART NUMBER
-5*	1/4	2005I
-8	13/32	2008I
-16	7/8	2016I
-20Z†	1-1/8	2020ZI

† The 16Z, and 20Z sizes have a double stainless steel wire reinforcement.

* Closed pitch coil with round wire.

Convuluted Hose

Conv-O-Crimp™

Everflex Conv-O-Crimp 8000 Series hose provides excellent performance, reliability and durability under a wide range of environmental, pressure, temperature and chemical conditions. When compared with large diameter rubber hose, Conv-O-Crimp is dramatically lighter weight, more flexible, and more resistant to heat and chemicals. The tube is fabricated with tape of PTFE and reinforced with 304 stainless steel wire. The result is a product ideally suited for applications in truck and bus, chemical processing, food processing, hydraulics, pharmaceutical, tire manufacturing, steel mills, and many others. In addition to the standard 8000 Series virgin white tube of PTFE, the 8500 Series has an internal conductive static dissipating black liner that provides a path to the hose end fitting for applications where flow induced electrostatic charges can occur.



Construction:
Convuluted PTFE tube with 304 stainless steel wire braid reinforcement.

Operating Temperature Range: -65° to + 400° F (-54°C to + 204°C)

Industrial applications include:

- Automotive
- Platten Presses
- Pharmaceutical
- Bus & Truck
- Reverse Osmosis
- Hydraulics
- Chemical Processing
- Steam, Air, Water
- Tire Manufacturing
- Electronics
- Steel Mills
- Food Processing
- Tank Truck Transfer

	HOSE SIZE	HOSE I.D.	NON-CONDUCTIVE CATALOG NUMBER	NOMINAL I.D. (IN.)	NOMINAL O.D. (IN.)	MAX OPERATING PRESSURE (PSI)	BURST PRESSURE (PSI) RM. TEMP.	MIN. BEND RAD. (IN.)	HOSE VACUUM (IN./HG)	WEIGHT (LB./FT.)
Non-Conductive										
	-8	1/2	8008	.53	.78	1550	6200	1.5	28	.23
	-12	3/4	8012	.78	1.05	1250	5000	2.5	28	.31
	-16	1	8016	1.03	1.32	1000	4000	3.0	20	.42
	-20	1-1/4	8020	1.28	1.58	1000	4000	3.5	12	.52
	-24	1-1/2	8024	1.53	1.83	750	3000	4.5	10	.59
	-32	2	8032	2.03	2.38	550	2200	6.0	5	.86
Conductive										
	-8	1/2	8508	.53	.78	1550	6200	1.5	28	.23
	-12	3/4	8512	.78	1.05	1250	5000	2.5	28	.31
	-16	1	8516	1.03	1.32	1000	4000	3.0	20	.42
	-20	1-1/4	8520	1.28	1.58	1000	4000	3.5	12	.52
	-24	1-1/2	8524	1.53	1.83	750	3000	4.5	10	.59
	-32	2	8532	2.03	2.38	550	2200	6.0	5	.86



WARNING: These hoses can be used to convey hazardous chemicals, steam, hot liquids or other dangerous materials which can cause death, serious bodily injury including burns, pressure wounds or chemical exposure if released accidentally. They should, therefore, only be handled or worked on by personnel properly trained in the safe handling of the materials or chemicals conveyed in the hoses.

Convuluted Hose

Hose Ends Conv-O-Crimp

Everflex Conv-O-Crimp hose end design is so unique, it is protected under U.S. Patent No. 5,209,267. In addition to the unique configuration of the hose end, Everflex ships every Conv-O-Crimp fitting with a factory installed sleeve on the insert. This eliminates the time consuming, costly and subjective step of wrapping the hose end with PTFE tape before assembly. The end result is a hose assembly system that is second to none in ease of assembly fabrication. Common industrial configurations are available in carbon steel and 316 stainless steel (wetted surfaces). Finished assemblies can be acquired from an authorized Everflex distributor or the Everflex factory.

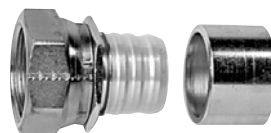

Material Code:
 A= Insert - 316S.S.,
 Nut & Collar - 304 S.S.
 B= Insert - 316 S.S.,
 Nut - 304 S.S.,
 Collar - Carbon Steel Plated
 C= All Components -
 Carbon Steel Plated

Male Pipe

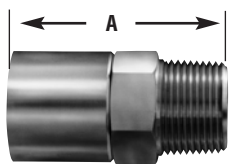

HOSE SIZE	HOSE I.D.	CATALOG NUMBER	PART NO. SUFFIX LETTER	THREAD NPT	A OVERALL LENGTH IN.	HOSE CUT-OFF FACTOR†	NOMINAL I.D. IN.
-8	1/2	8-108	A,B,C	1/2-14	2.33	1.38	.406
-12	3/4	12-112	A,B,C	3/4-14	2.48	1.38	.625
-16	1	16-116	A,B,C	1 11-1/2	2.95	1.76	.828
-20	1-1/4	20-120	A,B,C	1 1/4-11-1/2	2.98	1.79	1.078
-24	1-1/2	24-124	A,B,C	1 1/2-11-1/2	3.01	1.82	1.305
-32	2	32-132	A,B,C	2 11-1/2	3.43	1.98	1.781

Male Pipe Inserts with PTFE Sleeves Installed

HOSE SIZE	CARBON STEEL INSERT	STAINLESS STEEL INSERT	CARBON STEEL COLLAR	STAINLESS STEEL COLLAR
-8	800108-8-CZ	800108-8-316	870000-8-CZ	870000-8-304
-12	800112-12-CZ	800112-12-316	870000-12-CZ	870000-12-304
-16	800116-16-CZ	800116-16-316	870000-16-CZ	870000-16-304
-20	800120-20-CZ	800120-20-316	870000-20-CZ	870000-20-304
-24	800124-24-CZ	800124-24-316	870000-24-CZ	870000-24-304
-32	800132-32-CZ	800132-32-316	870000-32-CZ	870000-32-304



WARNING: Selection of the proper end fitting for the hose end application is essential to the proper operation and safe use of the hose and related equipment. Inadequate attention to the selection of the end fittings for your application can result in leaking or the hose end blowing off the hose, leading to serious personal injury, death or property damage.

† To determine the correct length of hose, subtract the cut-off factor for each end fitting from the overall length of assembly.

Convuluted Hose

Hose Ends Conv-O-Crimp

Material Code:

A= Insert - 316S.S.,
Nut & Collar - 304 S.S.

B= Insert - 316S.S.
Nut - 304 S.S.,
Collar - Carbon Steel Plated

C= All components - Carbon
Steel Plated

JIC 37° Swivel

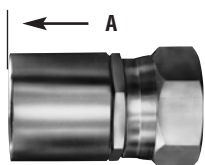

HOSE SIZE	HOSE I.D.	CATALOG NUMBER	PART NO. SUFFIX LETTER	THREAD NPT	A OVERALL LENGTH IN.	HOSE CUT-OFF FACTOR†	NOMINAL I.D. IN.
-8	1/2	8-608	A,B,C	3/4-16	1.82	1.32	.406
-12	3/4	12-612	A,B,C	1 1/6-12	2.01	1.46	.625
-16	1	16-616	A,B,C	1 5/16-12	2.14	1.55	.828
-20	1-1/4	20-620	A,B,C	1 5/8-12	2.20	1.64	1.078
-24	1-1/2	24-624	A,B,C	1 7/8-12	2.27	1.81	1.305
-32	2	32-632	A,B,C	2 1/2-12	2.62	2.10	1.781

JIC 37° Swivel Inserts with PTFE Sleeves Installed

HOSE SIZE	CARBON STEEL INSERT	STAINLESS STEEL INSERT	CARBON STEEL COLLAR	STAINLESS STEEL COLLAR
-8	820008-8-CZ	820008-8-316	870000-8-CZ	870000-8-304
-12	820012-12-CZ	820012-12-316	870000-12-CZ	870000-12-304
-16	820016-16-CZ	820016-16-316	870000-16-CZ	870000-16-304
-20	820020-20-CZ	820020-20-316	870000-20-CZ	870000-20-304
-24	820024-24-CZ	820024-24-316	870000-24-CZ	870000-24-304
-32	820032-32-CZ	820032-32-316	870000-32-CZ	870000-32-304

Flange Retainer

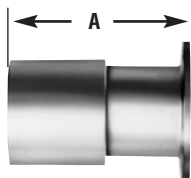

HOSE SIZE	HOSE I.D.	CATALOG NUMBER	PART NO. SUFFIX LETTER	A OVERALL LENGTH IN.	HOSE CUT-OFF FACTOR†	NOMINAL I.D. IN.
-8	1/2	8-F00	A,B	2.13	1.31	.406
-12	3/4	12-F00	A,B	2.43	1.43	.625
-16	1	16-F00	A,B	2.58	1.50	.828
-20	1-1/4	20-F00	A,B	2.60	1.56	1.078
-24	1-1/2	24-F00	A,B	2.72	1.62	1.305
-32	2	32-F00	A,B	3.11	1.81	1.781

Flange ordered separately. See chart.

Sanitary Tri-Clamp

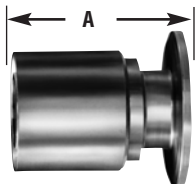

HOSE SIZE	HOSE I.D.	CATALOG NUMBER	PART NO. SUFFIX LETTER	A OVERALL LENGTH IN.	HOSE CUT-OFF FACTOR†	NOMINAL I.D. IN.
-16	1	16-S16	A	2.14	1.06	.828
-24	1-1/2	24-S24	A	2.14	1.06	1.305
-32	2	32-S32	A	2.40	1.06	1.781

WARNING: Selection of the proper end fitting for the hose end application is essential to the proper operation and safe use of the hose and related equipment. Inadequate attention to the selection of the end fittings for your application can result in leaking or the hose end blowing off the hose, leading to serious personal injury, death or property damage.

† To determine the correct length of hose, subtract the cut-off factor for each end fitting from the overall length of assembly.

Convuluted Hose

Hose Ends Conv-O-Crimp

Material Code:

A= Insert - 316SS,
Nut & Collar - 304 S.S.

CS=Carbon Steel

304=304 Stainless Steel

316=316 Stainless Steel

150 lb. ANSI Flange

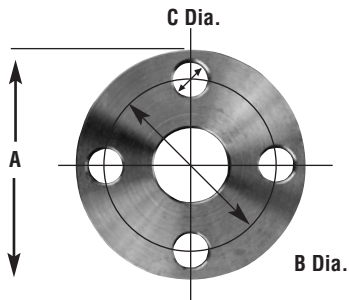

HOSE SIZE	HOSE I.D.	CATALOG NUMBER	PART NUMBER SUFFIX	NUMBER BOLT HOLES	A	B	C
-8	1/2	CF15-8	CS,304,316	4	3.50	2.38	.62
-12	3/4	CF15-12	CS,304,316	4	3.88	2.75	.62
-16	1	CF15-16	CS,304,316	4	4.25	3.12	.62
-20	1-1/4	CF15-20	CS,304,316	4	4.63	3.50	.62
-24	1-1/2	CF15-24	CS,304,316	4	5.00	3.88	.62
-32	2	CF15-32	CS,304,316	4	6.00	4.75	.75

300 lb. ANSI Flange

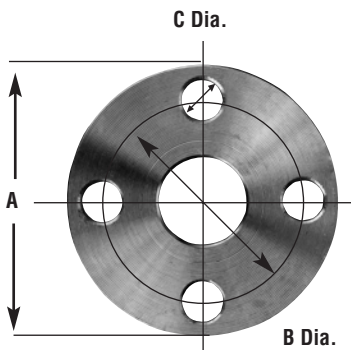

HOSE SIZE	HOSE I.D.	CATALOG NUMBER	PART NUMBER SUFFIX	NUMBER BOLT HOLES	A	B	C
-8	1/2	CF 30-8	CS,304,316	4	3.50	2.38	.62
-12	3/4	CF 30-12	CS,304,316	4	3.88	2.75	.62
-16	1	CF 30-16	CS,304,316	4	4.25	3.12	.62
-20	1-1/4	CF 30-20	CS,304,316	4	4.63	3.50	.62
-24	1-1/2	CF 30-24	CS,304,316	4	5.00	3.88	.62
-32	2	CF 30-32	CS,304,316	4	6.00	4.75	.75



WARNING: Selection of the proper end fitting for the hose end application is essential to the proper operation and safe use of the hose and related equipment. Inadequate attention to the selection of the end fittings for your application can result in leaking or the hose end blowing off the hose, leading to serious personal injury, death or property damage.

Everflex Hose Assemblies

Please contact Eaton Customer Service with a description of the hose assemblies/fitting combinations that you will require. For the fastest turnaround on Everflex hose assemblies, please consult your local Eaton hose distributor.

Equipment and Tooling Everswage

T-400-1EF Everswage Press



T-401-EF Fabricating Distributor Kit

Fabricating distributor kit including a press with master pusher, hydraulic pump, hose assembly, swage die holder, pusher adapters, and swage dies for 'S' Series, .040 wall hose -4 to -16.

T-400-71 Conversion Kit for Weatherhead T-400-1 Press

Conversion kit for Weatherhead T-400-1 press including master pusher, swage die holder, and pusher adapters.

T-400-89 Conversion Kit for Weatherhead T-400-1 Press

Conversion kit for Weatherhead T-400-1 press including master pusher, swage die holder, pusher adapter and swage dies for 'S' Series, .040 wall hose -4 to -16.

TE-Kit

Includes all tube expanders for smooth bore hose.



WARNING: You must hold the hose assembly in place from below throughout the swage or crimping operation. Do not place fingers or hands at the swage or crimping point during operation. Failure to follow this procedure could result in serious injury to your hand or finger.

The use or intermixing of fittings and hose not specifically engineered and designed for use with the Everflex equipment may result in the production of an unsafe or unreliable hose assembly. The Everflex limited warranty is contingent upon the fact that only Everflex end fittings and Everflex hose be used on Everflex assembly equipment.

MODEL #	DESCRIPTION
T-400-1EF	Everswage Press w/ Master Pusher
T-400-16	Hose Assembly
T-400-72	Pusher Adapter
T-400-73	Pusher Adapter
T-400-74	Pusher Adapter
T-400-75	Pusher Adapter
T-400-76	Pusher Adapter
T-400-77	Pusher Adapter
T-400-78	Pusher Adapter
T-400-79	Pusher Adapter
T-400-80	Pusher Adapter
T-400-81	Pusher Adapter
T-400-82	Pusher Adapter
PT-Pusher	Power Trim Fitting Pusher
T-400-84	Master Pusher
T-400-85	Swage Die Holder
T-421U	Hydraulic Pump
T-400-BB	Convert switch for T-421U Pump
TE-3	Tube Expander for -3
TE-4	Tube Expander for -4
TE-5	Tube Expander for -5
TE-6	Tube Expander for -6
TE-8	Tube Expander for -8
TE-10	Tube Expander for -10
TE-12	Tube Expander for -12

MODEL #	DESCRIPTION
TE-16	Tube Expander for -16
TE-20	Tube Expander for -20
T-400-ED	Pusher Selector Decal
.040" Wall	Swage Dies
SD-3-15	Swage Die 1/8"
SD-4-15	Swage Die 3/16"
SD-5-15	Swage Die 1/4"
SD-6-15	Swage Die 5/16"
SD-8-15	Swage Die 13/32"
SD-10-15	Swage Die 1/2"
SD-12-15	Swage Die 5/8"
SD-16-15	Swage Die 7/8"
SD-20Z-15	Swage Die 1-1/8"
.030 Wall	Swage Dies
SD-4TW-15	Swage Die 3/16" TW
SD-5TW-15	Swage Die 1/4" TW
SD-6TW-15	Swage Die 5/16" TW
SD-8TW-15	Swage Die 13/32" TW
SD-10TW-15	Swage Die 1/2" TW
SD-12TW-15	Swage Die 5/8" TW
SD-16TW-15	Swage Die 7/8" TW
EFH-135X	50 Drawer Cabinet
EFS-100	Blank Labels for EFH-135X

T-421U Electric Pump



Dimensions	7 1/2" high, 10" wide, 22" long
Weight	66 lbs.
Reservoir Size	145 cu. in.
Outlet Port Size	3/8" NPT or 3/4"-16 Straight Thread
Motor	1 H.P., 3450 RPM, 115/220 Volts, 60 Cycles, Single Phase
Hydraulic Oil	Gulf Harmony 100 AW Gulf Harmony 64 or 68, SAE 10 Grade, SAE 20 Grade, Sunvis 931, Mobil DTE 26 or, Mobil DTE 24 (30° F Below)
Reservoir Capacity	3 Quarts
Flow	0.5 GPM

Tooling Selector Chart Everswage

HOSE I.D.	HOSE END	0.040" WALL HOSE SWAGE DIE	0.030" WALL HOSE SWAGE DIE	PUSHER ADAPTER	0.040" WALL HOSE DIA	0.030" WALL HOSE DIA
3/32	1103	SD-3-15	NA	T-400-73	.308	.367
3/16	1104-1	SD-4-15	SD-4TW-15	T-400-73	.382	.367
3/16	1104-2	SD-4-15	SD-4TW-15	T-400-72	.382	.453
1/4	1105	SD-5-15	SD-5TW-15	T-400-72	.468	.453
1/4	1105-1/8	SD-5-15	SD-5TW-15	T-400-73	.468	.453
5/16	1106-1	SD-6-15	SD-6TW-15	T-400-72	.533	.518
5/16	1106-2	SD-6-15	SD-6TW-15	T-400-80	.533	.518
5/16	1106-3	SD-6-15	SD-6TW-15	T-400-78	.533	.518
13/32	1108-1	SD-8-15	SD-8TW-15	T-400-79	.632	.614
13/32	1108-2	SD-8-15	SD-8TW-15	T-400-78	.632	.614
1/2	1110	SD-10-15	SD-10TW-15	T-400-77	.739	.724
5/8	1112	SD-12-15	SD-12TW-15	T-400-76	.883	.875
7/8	1116	SD-16-15	SD-16TW-15	T-400-74	1.194	1.179
7/8	1116Z	SD-16-15	NA	T-400-74	1.194	NA
1-1/8	1120Z	SD-20Z-15	NA	Not Needed	1.423	NA
3/32	1303	SD-3-15	NA	T-400-81	.308	NA
3/32	1303-4	SD-3-15	NA	T-400-81	.308	NA
3/16	1304	SD-4-15	SD-4TW-15	T-400-81	.382	.367
1/4	1305	SD-5-15	SD-5TW-15	T-400-72	.468	.453
5/16	1306	SD-6-15	SD-6TW-15	T-400-72	.533	.518
13/32	1308	SD-8-15	SD-8TW-15	T-400-78	.632	.614
1/2	1310	SD-10-15	SD-10TW-15	T-400-76	.739	.724
5/8	1312	SD-12-15	SD-12TW-15	T-400-76	.883	.875
7/8	1316	SD-16-15	SD-16TW-15	T-400-75	1.194	1.179
7/8	1316Z	SD-16-15	NA	T-400-75	1.194	NA
1-1/8	1320Z	SD-20Z-15	NA	T-400-74	1.423	NA
3/16	#30	SD-4-15	SD-4TW-15	T-400-81	.382	.367
1/4	#31	SD-5-15	SD-5TW-15	T-400-72	.468	.453
5/16	#32	SD-6-15	SD-6TW-15	T-400-72	.533	.518
13/32	#33	SD-8-15	SD-8TW-15	T-400-78	.632	.614
1/2	#34	SD-10-15	SD-10TW-15	T-400-76	.739	.724
5/8	#35	SD-12-15	SD-12TW-15	T-400-76	.883	.875
3/16	2104-1	SD-4-15	SD-4TW-15	T-400-82	.382	.367
3/16	2104-2	SD-4-15	SD-4TW-15	T-400-81	.382	.367
1/4	2105	SD-5-15	SD-5TW-15	T-400-81	.468	.453
3/16	STE4-4	SD-4-15	SD-4TW-15	TE4-4 With T-400-75	.382	.367
1/4	STE4-5	SD-5-15	SD-5TW-15	TE4-5 With T-400-75	.468	.453
5/16	STE6-6	SD-6-15	SD-6TW-15	TE6-6 With T-400-75	.533	.518
13/32	STE8-8	SD-8-15	SD-8TW-15	TE8-8 With T-400-75	.632	.614
5/8	STE12-12	SD-12-15	SD-12TW-15	TE12-12 With T-400-75	.883	.875
7/8	STE16-16	SD-16-15	SD-16TW-15	TE16-16 With T-400-75	1.194	1.179
5/16	B-6LFC	SD-6-15	SD-6TW-15	T-400-73	.533	.518
5/8	#60	SD-12-15	SD-12TW-15	Consult Factory	.883	.875
7/8	#61	SD-16-15	SD-16TW-15	Consult Factory	1.194	1.179
7/8	#62	SD-16-15	SD-16TW-15	Consult Factory	1.194	1.179
1/4	C-5PS	SD-5-15	SD-5TW-15	T-400-81	.468	.453
3/16	PT-S-4	SD-4-15	SD-4TW-15	PT-Pusher	.382	.367
3/16	PT-45-4	SD-4-15	SD-4TW-15	PT-Pusher	.382	.367
3/16	PT-90-4	SD-4-15	SD-4TW-15	PT-Pusher	.382	.367
1/2	10-S.37-316	SD-10-15	SD-10TW-15	T-400-82	.739	.724
7/8	16-S.87-316	SD-16-15	SD-16TW-15	T-400-82	1.194	1.179
1/2	#40	SD-10-15	Sd-10TW-15	40 With T-40-75	.739	.724
1/2	#41	SD-10-15	SD-10TW-15	TE10-10 With T-400-75	.739	.724

Assembly Procedures Everswage

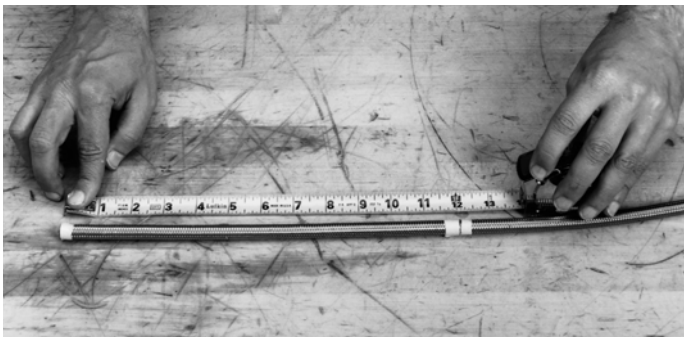
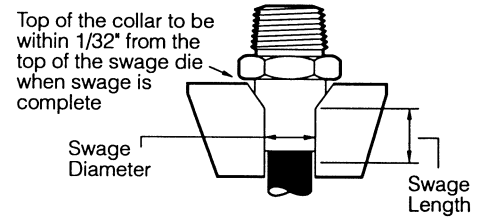
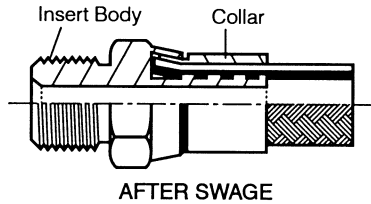
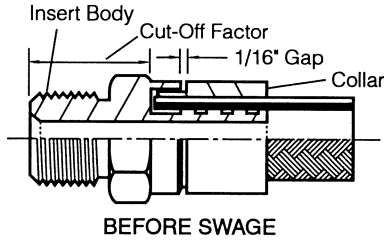

1) Measure hose to desired cut-off length. Wrap cut-off point with masking tape and mark. Desired length is

determined by subtracting deduct factor of both hose ends from overall length of hose assembly.



2) Cut hose squarely with cut-off saw as shown. (Abrasive and steel wheels perform well.)



3) Slide collars over hose, where braid is more tapered to the tube, for easier collar placement. Remove masking

tape and make sure collar has proper orientation.



4) Expand the inner PTFE tube for hose end insertion. Use the proper TE expander

with rotational speed not to exceed 200 rpm.

Assembly Procedures Everswage



5) Holding collar flush with the cut end, push the hose and collar over the stem of the fitting insert until the collar bottoms in the trepan cavity. (Exceptions; Sizes -3,

-4. Push hose and collar to the entrance of the short collar, then slide the collar forward over the hose until it is seated in the trepan cavity.)



6) Insert correct pusher adapter into the master pusher. Refer to selector chart T-400-ED on the front of press.



7) Place correct swage die halves into swage die holder T-400-85. Refer to selector chart T-400-ED.



8) Lubricate collar with dry PTFE lubricant prior to swaging.

Assembly Procedures Everswage



9) Place hose assembly in swage dies so bottom of collar rests in chamfered opening of dies.



10) Slide swage die holder back against the rear locating stops.



11) Hold hose assembly from underneath press and activate pump to swage hose end to hose. When pusher bottoms out on split die, swaging is complete.

Release electric switch to retract pusher. Slide swage die holder forward.



12) Remove swaged hose assembly and visually inspect the swaged end.

To ensure a proper swage has been completed, measure the nominal crimp diameter.

Tooling Selector Chart 'E' Series

Nominal Crimp Diameter Measurement

Measuring crimp diameters should be a part of the nominal hose assembly procedure. To insure a proper crimp diameter reading, follow these steps.

1. Measure the diameter in the middle of the crimped portion of the hose end. (see illustration #1)
2. Place the caliper in a position to allow a measurement in the horizontal depressions of the crimp spaced 180° apart. (see illustration #1 & #2)
3. See crimp diameters on the following chart.

Note: In the larger sizes, calipers may be used; however in the smaller sizes, a point micrometer will provide an accurate reading.

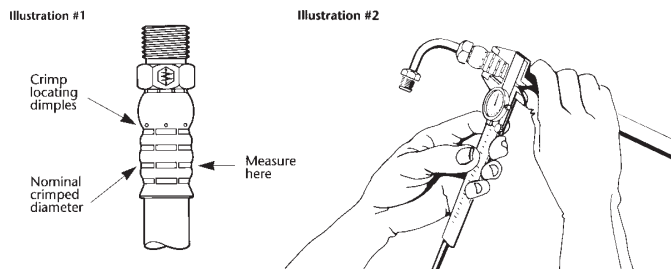

MODEL #	DESCRIPTION
T-400-30C	Kit includes 1 each of all collets
FS-1200	Label set/Layout Guide
T-400-8	Die Ring S-5TW
T-432-15	Master Pusher
T-400-37	Green Spacer Ring
T-400-38	Red Spacer Ring
T-400-112	Tan Spacer Ring

'E' Series Tooling

(For crimping 'E' series hose ends using the Everswage Press)

HOSE DASH SIZE	HOSE I.D.	HOSE END PREFIX	COLLET	SPACER RING COLOR	SPACER RING FLAT SIZE (UP OR DOWN)	NOMINAL CRIMP DIA +/- .003"
FC807-04, S-4TW	3/16	03E	T-400-113C	Tan	Up	.355
FC807-05, S-5TW	1/4	04E	T-400-31C	Green	Up	.405
FC807-06, S-6TW	5/16	05E	T-400-32C	Red	Up	.475
S-7TW	3/8	06E	T-400-33C	Red	Up	.545
S-10TW	1/2	08E	T-400-34C	Red	Up	.695
S-14TW	3/4	12E	T-400-35C	Red	Up	.978
S-18ZTW	1	16E	T-400-36C	Red	Up	1.225

NOTE: Spacer Rings not included in T-400-30C Kit.

Assembly Procedures 'E' Series

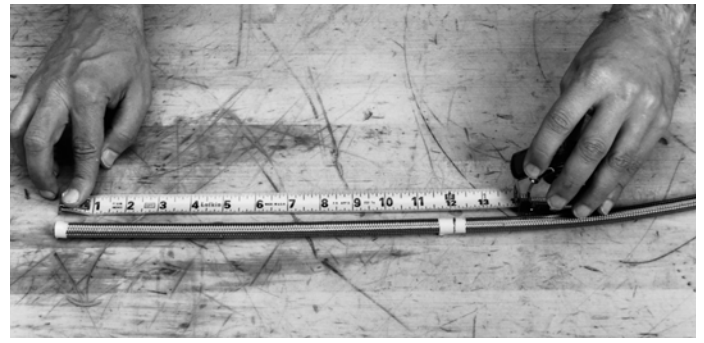

1) Measure hose to desired length. Wrap cut-off point with masking tape and mark. Desired length is determined by subtracting deduct factor of both ends from overall length of hose assembly.



2) Cut hose squarely with cut-off saw as shown. (Abrasive and steel wheels perform well.)

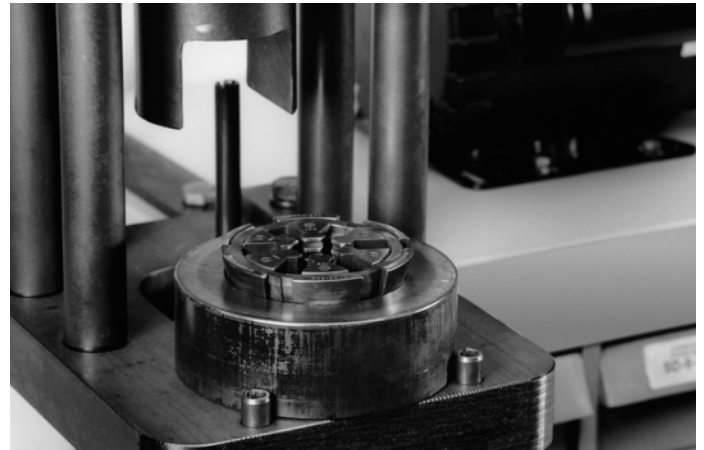

3) Place crimp die ring T-400-8 on base plate against the front stops. Insert correct collet halves in die ring.



4) Place proper size 'E' series hose end on hose. Be sure hose is bottomed in hose end and tape is removed from hose.

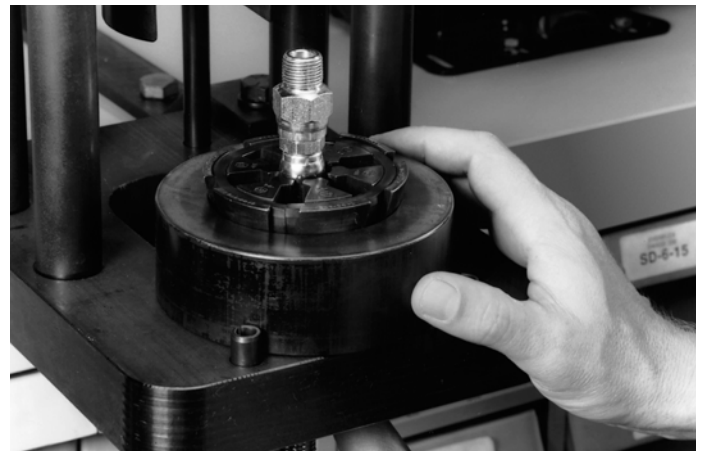

5) Insert hose assembly from below collet halves. Align the dimples on the hose end collar with top of the collet.

Assembly Procedures 'E' Series



6) Place appropriate side of correct spacer ring on top of collet with uncrimped hose assembly held in place.

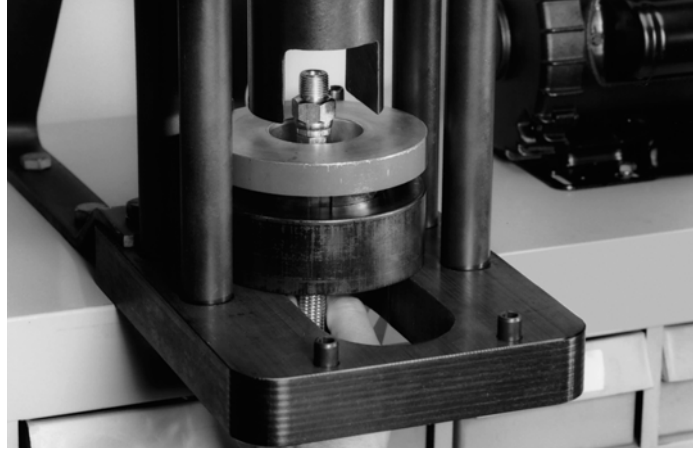

7) Slide crimp die ring back against the rear locating stops.



8) Hold hose assembly from underneath press and activate pump to crimp hose end to hose. When spacer ring contacts die ring, crimping is complete. Release the

electric switch to retract pusher. Slide crimp die ring forward.



9) Remove crimped hose assembly and visually inspect the crimped end. The crimp on the collar should be located $\pm 1/16$ " from the

dimples. To insure a proper crimp has been completed, measure the nominal crimp diameter.

Equipment and Tooling

Conv-O-Crimp

T-440-1EF Conv-O-Crimp Press Only



Conv-O-Crimp tooling equipment allows you to make custom factory quality hose assemblies quickly, conveniently and economically. The T-440-1EF press offers the crimping capabilities of 1/2" through 2" I.D. convoluted PTFE hose.

Weight: 450 lbs.

Size: 27" High, 21" Deep

T-440-1EFKIT :

Kit includes a press, hydraulic pump, hose assembly, and foot switch kit.

WARNING: You must hold the hose assembly in place from below throughout the swage or crimping operation. Do not place fingers or hands at the swage or crimping point during operation. Failure to follow this procedure could result in serious injury to your hand or finger.

The use or intermixing of fittings and hose not specifically engineered and designed for use with the Everflex equipment may result in the production of an unsafe or unreliable hose assembly. The Everflex limited warranty is contingent upon the fact that only Everflex end fittings and Everflex hose be used on Everflex assembly equipment.

T-890021 Conversion Kit for Weatherhead T-410-1 Press

Kit includes new pusher halves and crimp locator

MODEL #	DESCRIPTION
T-440-1EF	Press
T-410-22	Hose Assembly
T-441	Electric Pump (two stage)
T-8000	Crimp Collet Kit (all 6 sizes)
T-8008	Collet - 1/2" I.D.
T-8012	Collet - 3/4" I.D.
T-8016	Collet - 1" I.D.
T-8020	Collet - 1 1/4" I.D.
T-8024	Collet - 1 1/2" I.D.
T-8032	Collet - 2" I.D.
T-890024	Tube Expander Kit (all six sizes)
T-890024-8	Tube Expander for -8 hose
T-890024-12	Tube Expander for -12 hose
T-890024-16	Tube Expander for -16 hose
T-890024-20	Tube Expander for -20 hose
T-890024-24	Tube Expander for -24 hose
T-890024-32	Tube Expander for -32 hose
T-890025	Flange Support Kit
T-890026	Foot Switch Kit
T-410-BB	Convert Switch for T-441 Pump

T-441 Electric Pump



Dimensions 7 1/2" high, 10" wide, 22" long

Weight 75 lbs.

Pressure 5000 psi

Reservoir Capacity 6 quarts Outlet Port

Size 3/4-16 straight thread o-ring

Motor 1 HP, 3450 RPM, 115.220 volts, 60 cycles, single phase.

Hydraulic Oil Automatic Transmission fluid (ATF)

Flow 2.5 GPM @ 750 psi 0.5 GPM @ 3500 psi

CAUTION: The T-441 electric pump has the relief valve set @ 4000 to 4200 psi.

Damage to the press will result and the warranty may be voided if higher pressures are used.

Assembly Procedures Conv-O-Crimp

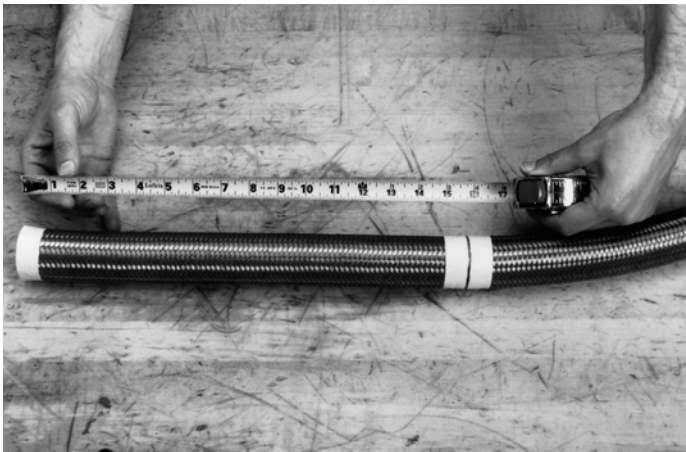

1) Measure hose to desired cut-off length. Wrap cut-off point with masking tape and mark. Desired length is

determined by subtracting deduct factor of both hose ends from overall length of hose assembly.



2) Cut hose squarely with cut-off saw as shown.

(An abrasive wheel performs well.)



3) Trim hose from cut hose ends.



3b) Remove debris (wheel grit and pieces of tubing) from cut hose ends.

Assembly Procedures Conv-O-Crimp



4) Remove masking tape and install collars on hose end.



5) Insert the appropriate size tube expander into the end of the hose. Do not exceed 200rpm.



6) Push hose with collar attached onto the desired hose end insert. Hose end should be held in vise as shown.



Assembly Procedures Conv-O-Crimp

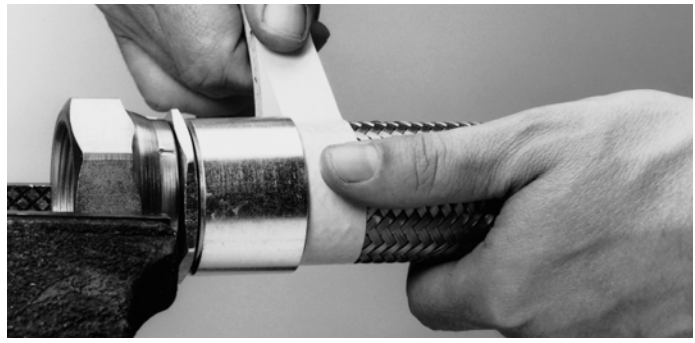

7) After hose end insert is installed, wrap hose with masking tape immediately behind the assembled uncrimped collar.

(Tape is used as a gauge to detect movement of the hose prior to or during the crimping operation.)

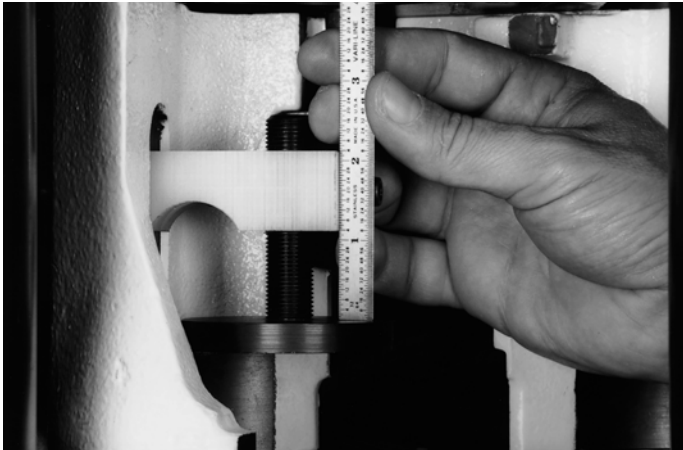

8) Adjust fitting crimp locator for appropriate hose end fitting configuration and then lock into place.

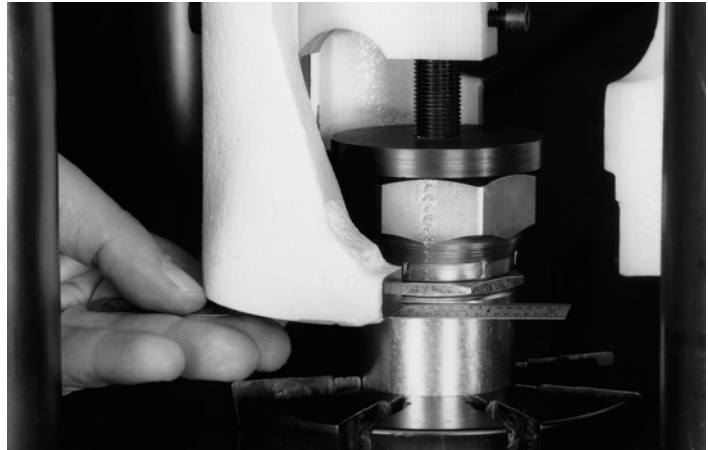

9) Insert hose end through the press base plate and install correct crimp collet.

Check locator dimension with scale to verify pusher bottom is in line with leading edge of the hose end collar.



10) Close both pusher halves. Hold hose assembly from below press and activate pump to crimp hose end to hose.

Lift hose end against the fitting locator prior to contact of the pusher with the crimp collet.



Assembly Procedures Conv-O-Crimp

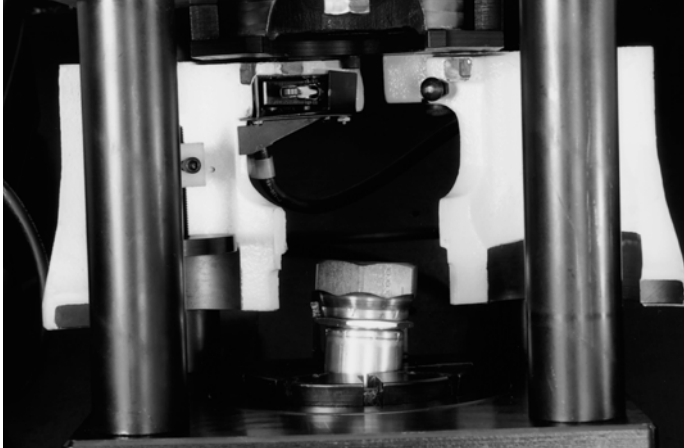

11) Release pressure and allow pusher halves to retract. Remove crimped hose end from press.



12) Visually inspect the crimped end. Check tape below collar to verify hose end did not move during assembly.

To insure a proper crimp has been completed, measure the nominal crimp diameter.

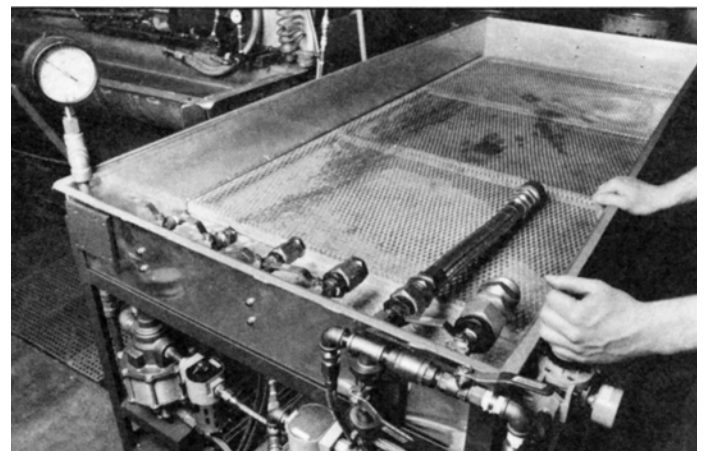

13) Pressure test the completed hose assembly to verify integrity.

Fitting Locator Adjustment and Tooling Selector Chart for Conv-O-Crimp

Instructions

1. Adjust locator stop to the 'L' dimension for desired fitting configuration. Secure stop with allen screw.
2. With fitting and crimp collet located in base plate, close pusher halves and energize pump.
3. Lift hose and fitting assembly against locator stop just prior to pusher contacting crimp collet.

CAUTION:

- 1) Pusher halves under ram must be closed before pressurizing.
- 2) Maximum operating pressure 5000 p.s.i.

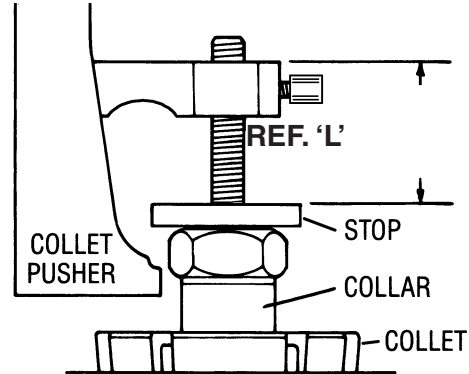

Ref. "L" Dimension Chart

HOSE I.D.	MALE NPT	JIC SWIVEL	PIPE FLANGE	SANITARY FLANGE
1/2	2-7/16	2-9/16	2-5/8	
3/4	2-7/16	2-7/16	2-1/2	
1	2-1/16	2-3/8	2-7/16	2-7/8
1-1/4	2-1/16	2-5/16	2-3/16	
1-1/2	2	2-1/8	2-3/16	2-7/8
2	1-13/16	1-3/4	2-3/16	2-7/8

Crimp Diameters for Conv-O-Crimp hose system with T-440-1EF Press

HOSE I.D.	TOOLING	CRIMP DIAMETER
1/2	T-8008	0.813 +/- 0.003
3/4	T-8012	1.063 +/- 0.003
1	T-8016	1.315 +/- 0.003
1-1/4	T-8020	1.563 +/- 0.003
1-1/2	T-8024	1.813 +/- 0.003
2	T-8032	2.338 +/- 0.003

Assembly Procedures Field Attachable Fittings

For use with PTFE Hose
FC807, STW, SCTW, H243, H277

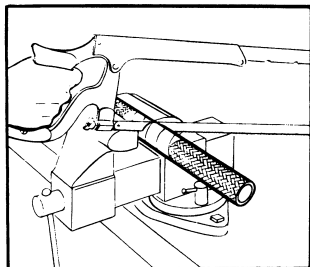

Step 1

Wrap hose with masking tape at cut-off point and cut square to length through taped area using a cut-off machine or fine-tooth hacksaw. Remove tape and trim any loose wires flush with tube stock. Any burrs on the bore of the tube stock should be removed with a knife. Clean the hose bore. Sometimes wire braid will tend to “neck down” on one end and flare out, on the opposite end. This is a characteristic of wire braid hose and can be used to an advantage in the assembly of the sockets. Slip two sockets back to back over the “necked down” end of the hose.

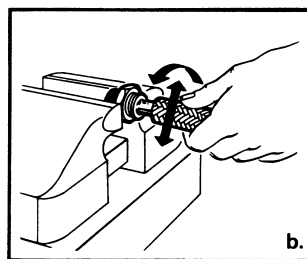
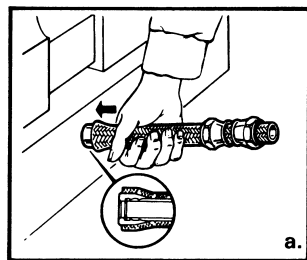

Step 2

a. Push the sleeve over the end of the tube and under the wire braid by hand. Complete positioning of the sleeve by pushing the hose end against a flat surface. Visually inspect to see that tube stock butts against the inside shoulder of the sleeve.

b. Set the sleeve barbs into the PTFE tube by using assembly tool FT1038A or working the hose bore over the nipple into the end of the sleeve and tube. Assembly kit FT1081 is also available as well as an Everflex Tube Expander.

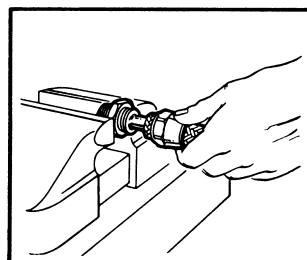

Step 3

Lubricate nipple and socket threads. For stainless steel fittings, use a molydisulfide-base lubricant. Lubricants containing chloride are not recommended. Other material combinations use standard petroleum lubricants. Hold the nipple with hex in vise. Push hose over nipple with twisting motion until seated against nipple chamfer. Push socket forward and hand start threading of socket to nipple.

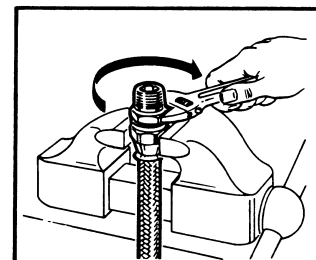

Step 4

Wrench tighten nipple hex until clearance with socket hex is 1/32” or less. Tighten further to align corners of nipple and socket hexes.

To disassemble: Unscrew and remove nipple; slide socket back on hose by tapping against flat surface; remove sleeve with pliers. New sleeves are recommended upon reuse of the fitting.

Assembly Equipment Field Attachable Fittings

FT1081

PTFE Hose Assembly Tool Kit

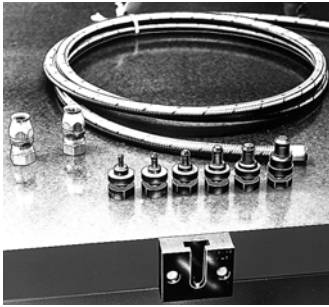

Hose Specifications

Smooth Bore PTFE Hose,
-03, -04, -05, -06, -08, -10
and -12 hose.

Features

- Inexpensive
- Easy to use
- Seats PTFE tube against sleeve

Ordering Instructions

FT1081 Complete tool kit.

Includes:

- FT1081-3-1 mandrel holder
- FT1081-3-2-3 mandrel -3 hose
- FT1081-3-2-4 mandrel -4 hose
- FT1081-3-3-5 mandrel -5 hose
- FT1081-3-4-6 mandrel -6 hose
- FT1081-3-5-8 mandrel -8 hose
- FT1081-3-6-10 mandrel -10 hose
- FT1081-3-7-12 mandrel -12 hose

FT1038A

PTFE Hose Tool



Hose Specifications

Smooth Bore PTFE Hose,
-03, -04, -05, -06, -08, -10, -12

Features

- Small
- Hand held tool

Chemical Resistance Chart - PTFE Only

Partial List of Chemicals

This chart has been prepared as a guide only and is NOT a guarantee.

The number of variables present in any particular chemical environment makes firm ratings impossible. Testing under actual service conditions is advisable in all cases to establish suitability of hose for a given purpose.

End fitting material compatibility ratings are based on a fluid temperature of 70° and higher temperatures may accelerate adverse affects.

Where unusual conditions exist, or where questions arise, please consult Eaton Technical Support for assistance.

KEY:

- B- Brass
- CS- Carbon Steel
- SS- Stainless Steel
- 1- Excellent
- 2- Good
- 3- Not Recommended
- 0- No Information - Test Before Using

MEDIA	PTFE	END FITTING MATERIAL			
		BRASS	CS	303/304 S.S.	316SS
Acetaldehyde	1	1	1	1	1
Acetic Acid 10%	1	3	3	2	2
Acetic Acid 30%	1	3	3	2	2
Acetic Acid Glacial	1	2	0	2	2
Acetic Anhydride	1	3	3	2	2
Acetone	1	1	1	1	1
Acetylene	1	2	0	1	1
Acrylonitrile	1	0	1	1	1
Acetyl Chloride	0	0	0	0	0
Alcohols	1	0	3	1	1
Allyl Chloride	0	0	0	0	0
Alum, Ammonium					
Or Potassium	1	3	3	2	2
Aluminum Acetate	1	3	0	1	1
Aluminum Bromide	1	3	3	2	2
Aluminum Chloride	1	3	3	2	2
Aluminum Fluoride	1	3	3	2	2
Aluminum Hydroxide	1	1	0	1	1
Aluminum Nitrite	1	0	3	1	1
Aluminum Oxychloride	0	0	0	0	0
Aluminum Salts	1	0	0	1	2
Aluminium Sulfate	1	3	3	3	2
Ammonia, Anhydrous	1	0	1	1	1
Ammonia, Aqueous	1	3	0	1	1
Ammonium Acetate	0	0	0	0	0
Ammonium Carbonate	0	0	1	1	1
Ammonium Chloride	1	3	0	2	2
Ammonium Fluoride	0	0	0	0	0
Ammonium Hydroxide	1	3	2	1	1

MEDIA	PTFE	END FITTING MATERIAL			
		BRASS	CS	303/304 S.S.	316SS
Ammonium Metaphosphate	1	0	1	1	1
Ammonium Nitrate	1	3	1	1	1
Ammonium Nitrite	0	0	0	1	1
Ammonium Persulfate	0	0	0	1	1
Ammonium Phosphate	1	0	3	2	1
Ammonium Sulfate	1	3	1	1	1
Ammonium Thiocyanate	1	0	1	1	1
Amyl Acetate	1	1	3	1	1
Amyl Alcohol	1	1	1	1	1
Amyl Chloride	1	0	0	1	1
Amyl Chloronaphthalene	1	0	0	1	1
Amyl Naphthalene	1	0	0	1	1
Aniline	1	3	2	1	1
Aniline Dyes	1	0	3	1	1
Aniline Hydroxide	1	3	0	3	3
Animal Fats	1	0	1	1	1
Antimony Chloride	0	0	0	0	0
Antimony Trochloride	0	0	0	0	0
Aqua Regia	1	0	0	3	3
Arsenic Acid	1	0	2	0	1
Askarel	0	1	1	1	1
Asphalt	1	2	1	1	1
Barium Carbonate	1	1	2	1	1
Barium Chloride	1	2	3	1	1
Barium Hydroxide	1	0	2	1	1
Barium Sulfate	1	2	1	1	1
Barium Sulfide	1	3	3	1	1
Beer	1	1	2	1	1

Chemical Resistance Chart - PTFE Only

MEDIA	END FITTING MATERIAL				
	PTFE	BRASS	CS	303/304 S.S.	316SS
Beet Sugar Liquids	1	0	1	1	1
Benzene	1	1	1	1	1
Benzenesulfonic Acid	0	0	3	0	2
Benzalsdehyde	1	0	1	0	0
Benzine	1	1	1	1	1
Benzyl Alcohol	1	0	1	1	1
Benzonic Acid	0	0	0	0	0
Benzoyl Chloride	0	0	0	0	0
Benzyl Benzoate	1	0	1	1	1
Benzyl Chloride	1	0	1	0	0
Bismuth Carbonate	1	0	1	1	1
Black Sulphate Liquor	1	0	1	1	1
Blast Furnace Gas	1	1	1	1	1
Borax	1	1	2	2	1
Bordeaux Mixture	1	0	0	1	1
Boric Acid	1	3	3	2	1
Brine	1	2	2	1	1
Bromine Gas	1	3	3	3	3
Bromine Liquid	1	3	3	3	3
Bromine Water	1	3	3	3	3
Bunker Oil	1	1	1	1	1
Butadiene	1	1	0	1	1
Butane	1	1	1	1	1
Butter Oil	1	1	1	1	1
Butyric Acid	1	2	3	1	1
Butyl Acetate	1	1	2	1	1
Butyl Alcohol	1	1	1	1	1
Butyl Amine	0	1	1	1	1
Butyl Carbitol	1	1	1	1	1
Butyl Chloride	0	0	0	0	0
Butyl Phenol	0	0	0	0	0
Butyl Stearate	1	1	1	1	1
Butyl Mercaptan	1	0	0	1	1
Butyraldehyde	1	1	0	0	0
Cadmium Cyanide	0	0	0	0	0
Calcium Acetate	1	1	1	1	1
Calcium Bisulfate	1	3	0	2	1
Calcium Carbonate	1	1	1	1	1
Calcium Chlorate	1	0	0	2	1
Calcium Chloride	1	2	3	2	1
Calcium Hydroxide	1	2	3	3	1
Calcium Hypochlorite	1	3	0	3	2
Calcium Nitrate	1	1	1	1	1

MEDIA	END FITTING MATERIAL				
	PTFE	BRASS	CS	303/304 S.S.	316SS
Calcium Silicate	1	1	1	1	1
Calcium Sulfate	1	1	1	1	1
Calcium Sulfide	1	0	1	1	1
Calcium Phosphate	0	0	0	0	0
Cane Sugar Liquors	1	2	1	1	1
Caprylic Acid	0	0	0	0	0
Carbonic Acid	1	3	3	1	1
Carbon Dioxide	1	1	1	1	1
Carbon Disulfide	0	2	2	1	1
Carbonic Acid	1	3	3	1	1
Carbon Monoxide	1	1	1	1	1
Carbon Tetrachloride	1	2	3	2	2
Castor Oil	1	1	1	1	1
Caustic Soda	1	3	2	1	1
Cellosolve, Acetate	1	0	1	1	1
Cellosolve, Butyl	1	0	1	1	1
Cellulube	1	1	1	1	1
Cetyl Alcohol	0	0	0	0	0
Chloroacetic Acid	1	2	3	3	3
Chloral Hydrate	0	0	0	0	0
Chlorine, Gaseous, Dry	1	2	2	3	3
Chlorine, Gaseous, Wet	1	3	3	3	3
Chlorine, Trifluoride	0	0	3	0	0
Chloroacetic, Acid	1	2	3	3	3
Chlorobenzene	1	1	1	1	1
Chloribenzene Chloride	0	0	0	0	0
Chlorobromomethane	1	1	1	1	1
Chloroform	1	1	1	1	1
O-Chloronaphthalene	1	1	1	1	1
Chlorosulfonic Acid	1	0	3	0	1
Chlorotoluene	1	1	1	1	1
Chromium Trioxide	0	0	0	0	0
Chromic Acid	1	3	3	3	2
Citric Acid	1	3	3	3	1
Cod Liver Oil	1	1	1	1	1
Code Oven Gas	1	0	1	1	1
Copper Chloride	1	3	3	3	1
Copper Cyanide	1	3	0	1	1
Copper Fluoride	0	0	0	0	0
Copper Nitrate	0	0	0	0	0
Copper Sulfate	1	3	3	1	1
Corn Oil	1	1	1	1	1
Corn Syrup	1	0	1	1	1

Chemical Resistance Chart - PTFE Only

MEDIA	PTFE	END FITTING MATERIAL			
		BRASS	CS	303/304 S.S.	316SS
Cottonseed Oil	1	1	1	1	1
Creosote	1	3	2	1	1
Cresol	1	0	2	1	1
Cresylic Acid	0	0	0	0	0
Crude Wax	1	1	1	1	1
Cutting Oil	1	1	1	1	1
Cyclohexane	1	1	1	1	1
Cyclohexanone	1	0	0	1	1
Cymene	1	1	0	0	0
Decalin	1	1	0	0	0
Denatured Alcohol	1	1	1	1	1
Diacetone	1	1	1	1	1
Diacetone Alcohol	1	1	1	1	1
Dibenzyl Ether	1	1	1	1	1
Dibutyl Ether	1	1	1	1	1
Dibutyl Phthalate	1	1	1	1	1
Dibutyl Sebacate	1	1	0	0	0
Dichlorethylene	0	0	0	0	0
Dichlorobenzene	1	1	0	1	1
Diesel Oil	1	1	1	1	1
Diethylamine	1	3	0	0	1
Diethyl Ether	1	1	1	1	1
Diethylene Glycol	1	1	1	1	1
Diethyl Phthalate	1	1	0	1	1
Diethyl Sebacate	1	1	0	1	1
Di-Isobutylene	0	1	0	1	1
Di-Isopropyl Ketone	1	1	0	1	1
Dimethyl Aniline	1	1	0	0	0
Dimethyl Formamide	0	0	1	1	1
Dimethyl Phthalate	1	1	0	1	0
Diocetyl Phthalate	1	1	1	1	1
Dioxane	1	1	1	1	1
Dipentene	1	1	1	1	1
Ethanolamine	1	1	1	1	1
Ethers	1	1	1	1	1
Ethyl Acetate	1	1	1	1	1
Ethyl Acetoacetate	1	1	1	1	1
Ethyl Acrylate	0	0	1	1	1
Ethyl Alcohol	1	2	1	1	1
Ethyl Benzene	1	1	1	1	1
Ethyl Bromide	0	0	0	0	0
Ethyl Cellulose	1	1	1	1	1
Ethyl Chloride	1	2	2	1	1
Ethyl Ether	1	1	2	1	1

MEDIA	PTFE	END FITTING MATERIAL			
		BRASS	CS	303/304 S.S.	316SS
Ethyl Lactate	0	0	0	0	0
Ethyl Mercaptan	1	0	2	0	0
Ethyl Pentochlorobenzene	1	1	2	1	1
Ethyl Silicate	1	1	1	1	1
Ethylene Chloride	1	2	2	1	1
Ethylene Chlorohydrin	1	0	0	0	0
Ethylene Diamine	1	1	0	0	0
Ethylene Dichloride	1	1	3	3	3
Ethylene Glycol	1	1	2	1	1
Ethylene Oxide	0	0	0	0	0
Fatty Acids	1	0	0	1	1
Ferric Chloride	1	3	3	3	3
Ferric Nitrate	1	0	3	1	1
Ferric Sulfate	1	3	3	1	1
Ferrous Chloride	1	2	3	1	2
Ferrous Nitrate	1	0	0	1	1
Ferrous Sulfate	1	2	3	1	1
Fluorine	0	0	0	0	0
Fluoroboric Acid	1	0	0	1	1
Formaldehyde	1	1	0	1	1
Formic Acid	1	2	3	2	1
Freon 12	2	0	3	1	1
Freon 114	2	0	3	1	1
Fuel Oil	1	1	2	2	2
Fumaric Acid	0	0	0	1	1
Furan Furfuran	1	1	1	1	1
Furfural	1	1	2	1	1
Gallic Acid	1	0	3	1	1
Gasoline	1	1	2	1	1
Glauber's Salt	0	0	1	1	1
Glucose	1	1	1	1	1
Glue	1	3	2	1	1
Glycerin	1	1	2	1	1
Glycerol	1	2	1	1	1
Glycols	1	1	1	1	1
Green Sulphate Liquor	1	0	1	1	1
Heptane	1	1	1	1	1
n-Hexaldehyde	1	1	1	1	1
Hexane	1	1	1	1	1
Hexene	1	1	1	1	1
Hexyl Alcohol	1	2	1	1	1
Hydraulic Oil, Petroleum	1	1	1	1	1
Hydrobromic Acid 10%	1	0	3	3	3
Hydrobromic Acid 30%	1	0	3	3	3

Chemical Resistance Chart - PTFE Only

MEDIA	PTFE	END FITTING MATERIAL			
		BRASS	CS	303/304 S.S.	316SS
Hydrochloric Acid 10%	1	3	3	3	3
Hydrochloric Acid 50%	1	3	3	3	3
Hydrochloric Acid Concentrate	1	3	3	3	3
Hydrocyanic Acid	1	0	3	0	1
Hydrofluoric Acid Concentrated	1	3	3	3	3
Hydrofluoric Acid 40%	1	3	3	3	3
Hydrofluoric Acid 60%	1	3	3	3	3
Hydrofluosilicic Acid	1	3	3	3	3
Hydrogen Bromide	0	0	0	0	0
Hydrogen Gaseous	1	1	1	1	1
Hydrogen Peroxide 70%	1	3	3	2	1
Hydrogen Sulfide Gaseous	1	3	3	2	1
Hydroquinone	0	0	0	1	1
Hydroxylamine Sulfate	0	0	0	0	0
Iodine	0	0	0	0	0
Isobutyl Alcohol	1	2	1	1	1
Iso Octane	1	1	1	1	1
Isopropyl Acetate	1	1	1	1	1
Isopropyl Alcohol	1	1	1	1	1
Isopropyl Ether	1	1	1	1	1
Kerosene	1	1	1	1	1
Ketones	0	0	0	1	1
Lacquers	1	1	3	3	1
Lacquers Solvents	1	1	3	2	1
Lactic Acid	1	2	3	2	1
Lard	1	3	1	1	1
Lead Acetate	1	1	2	1	1
Lead Nitrate	1	1	2	1	1
Lyme Bleach	0	0	3	2	1
Linoleic Acid	1	0	0	0	0
Linseed Oil	1	2	2	1	1
Lubricating Oils, Petroleum	1	1	1	1	1
Magnesium Chloride	1	2	3	2	1
Magnesium Hydroxide	1	0	1	1	1
Magnesium Nitrate	0	0	0	0	0
Magnesium Sulfate	1	1	2	1	1
Malic Acid	1	0	2	2	1
Mercuric Chloride	1	3	3	1	1
Mercury	1	3	1	1	1
Mesityl Oxide	1	1	1	1	1
Methanol	1	1	0	1	1
Methyl Acetate	1	1	1	1	1

MEDIA	PTFE	END FITTING MATERIAL			
		BRASS	CS	303/304 S.S.	316SS
Methyl Acrylate	0	1	1	1	1
Methyl Alcohol	1	2	1	1	1
Methyl Bromide	1	1	1	1	1
Methyl Butyl Katone	0	1	1	1	1
Methyl Chloride	1	1	1	1	1
Methylene Chloride	1	1	1	1	1
Methylethyl Ketone (MEK)	1	1	1	1	1
Methyl Formate	1	1	1	1	1
Methyl Isobutyl Ketone	1	1	1	1	1
Methyl Methacrylate	1	0	1	1	1
Methyl Salicylate	1	1	1	1	1
Methyl Sulphate	0	0	0	0	0
Methyl Trichlorosilane	0	0	0	0	0
Milk	1	3	3	1	1
Mineral Oil	1	1	1	1	1
Molasses	0	0	0	0	0
Monochlorobenzene	1	1	1	1	1
Monoethanolamine	0	1	1	1	1
Naptha	1	1	2	1	1
Napthalene	1	0	0	1	1
Naphthenic Acid	1	0	0	2	1
Natural Gas	1	2	1	1	1
Nickel Acetate	1	1	1	1	1
Nickel Chloride	1	3	3	2	2
Nickel Nitrate	0	0	0	0	0
Nickel Sulfate	1	3	0	2	1
Niter Cake	0	0	3	2	1
Nitric Acid 5%	1	3	3	2	2
Nitric Acid 10%	1	3	3	2	2
Nitric Acid 30%	1	3	3	2	2
Nitric Acid above 30%	1	3	3	2	2
Nitric Acid, Red Fuming	1	3	3	2	2
Nitrobenzene	1	1	1	1	1
Nitroethane	1	1	0	1	1
Nitrogen, Gaseous	1	1	1	1	1
Nitrogen Tetroxide	0	0	0	0	2
Nitrous Acid	0	0	0	0	0
Nitrous Oxide	0	0	0	0	0
n-Octane	0	1	1	1	1
Octyl Alcohol	1	2	1	1	1
Oil, SAE	1	1	1	1	1
Oleic Acid	1	2	2	2	1
Olive Oil	1	2	2	2	1
Oxalic Acid	1	3	3	2	1

Chemical Resistance Chart - PTFE Only

MEDIA	PTFE	END FITTING MATERIAL			
		BRASS	CS	303/304 S.S.	316SS
Oxygen Gaseous	1	1	1	1	1
Ozone	1	1	1	1	1
Paint	1	1	0	1	1
Palmitic Acid	1	3	1	2	1
Peanut Oil	1	1	1	1	1
Perchloric Acid	1	0	0	2	1
Perchloroethylene	1	1	1	1	1
Petroleum	1	1	1	1	1
Phenol	1	3	3	1	1
Phorone	1	1	1	1	1
Phosgene	0	0	0	0	0
Phosphoric Acid 20%	1	3	3	0	2
Phosphoric Acid 100%	1	3	3	0	2
Picric Acid	1	3	3	1	1
Pinene	1	1	1	1	1
Pine Oil	1	0	1	1	1
Plating Solutions Brass	0	0	0	0	0
Cadmium	0	0	0	0	0
Chrome	1	0	0	3	3
Potassium Acetate	1	0	0	1	1
Potassium Chloride	1	3	2	2	1
Potassium Cyanide	1	3	2	1	1
Potassium Dichromate	1	0	0	1	1
Potassium Hydroxide 30%	1	3	3	1	1
Potassium Hydroxide 100%	1	2	3	1	1
Potassium Nitrate	1	2	3	1	1
Potassium Sulfate	1	2	2	1	1
Propane	1	1	1	1	1
Propyl Acetate	0	1	1	1	1
Propyl Alcohol	1	2	1	1	1
Pyridine 50%	1	1	0	1	1
Red Oil	1	2	2	2	1
Salicylic Acid	0	0	0	1	1
Salt Water	1	3	2	1	1
Sewage	1	1	3	1	1
Silicone Greases	0	1	1	1	1
Silicone Oils	0	1	1	1	1
Silver Cyanide	0	0	0	0	0
Silver Nitrate	1	2	2	1	1
Skydrol 500 & 7000	1	0	1	1	1
Soap Solutions	1	1	1	1	1
Soda Ash	0	2	1	1	1
Sodium Acetate	1	1	1	1	1
Sodium Benzoate	1	2	2	1	1

MEDIA	PTFE	END FITTING MATERIAL			
		BRASS	CS	303/304 S.S.	316SS
Sodium Bicarbonate	1	2	2	1	1
Sodium Bisulfate	1	0	1	1	1
Sodium Borate	1	0	1	1	1
Sodium Chloride	1	3	2	2	1
Sodium Cyanide	1	3	2	1	1
Sodium Chlorate	0	0	0	0	0
Sodium Hydroxide 30%	1	3	2	1	1
Sodium Hydroxide 40%	1	3	2	1	1
Sodium Hydroxide 100%	1	3	2	2	1
Sodium Chlorite	0	0	0	0	0
Sodium Metaphosphate	1	3	3	1	1
Sodium Nitrate	1	2	1	1	1
Sodium Perborate	1	3	3	1	1
Sodium Peroxide	1	3	3	1	1
Sodium Phosphate	1	3	0	1	1
Sodium Thiosulfate	1	3	3	1	1
Soybean Oil	1	0	1	1	1
Stannic Chloride	1	3	3	0	0
Starch	0	0	0	0	0
Steam	1	2	1	1	1
Stearic Acid	1	3	3	2	1
Stoddard Solvent	1	1	2	1	1
Styrene	1	2	2	0	2
Sucrose Solution	1	0	1	1	1
Sulfur 200° F	1	3	2	2	1
Sulfur Chloride	1	3	3	3	2
Sulfur Dioxide	1	1	2	1	1
Sulfur Dioxide Liquid	1	0	0	0	0
Sulfur Dioxide Wet Gas	1	0	0	0	0
Sulfur Monochloride	0	0	0	0	0
Sulfur Trioxide	1	0	2	2	2
Sulfur Trioxide Liquid	0	0	0	0	0
Sulfur Trioxide Wet Gas	0	0	0	0	0
Sulfuric Acid 10%	1	3	3	3	2
96%	1	3	3	3	2
98%	1	3	2	3	2
100%	1	0	0	0	0
Fuming	1	3	2	0	1
Sulfurous Acid 10%	1	3	3	2	1
Sulfurous Acid 75%	1	3	3	3	2
Tallow	0	0	0	0	0
Tannic Acid 10%	1	3	2	1	1
Tar, Bituminous	1	2	1	1	1
Tartaric Acid	1	0	0	2	2

Chemical Resistance Chart - PTFE Only

MEDIA	PTFE	END FITTING MATERIAL			
		BRASS	CS	303/304 S.S.	316SS
Tetrachloroethylene	0	0	0	0	0
Terpineol	1	0	0	0	0
Titanium Tetrachloride	0	3	1	2	2
Toluene	1	1	1	1	1
Toluene Diisocyanate	0	0	0	0	0
Transformer Oil	1	1	1	1	1
Transmission Fluid Type A	1	1	1	1	1
Tributoxyethyl Phosphate	1	0	1	0	0
Tributyl Phosphate	1	0	1	0	0
Trichloroacetic Acid 10%	0	0	0	0	0
Trichloroacetic Acid 100%	0	0	0	0	0
Trichlorethylene	1	1	3	0	1
Trichloroethylene	1	0	3	0	1
Trichlorophenol	0	0	0	0	0
Tricresyl Phosphate	1	0	1	0	2
Tung Oil	1	1	1	1	1
Turpentine	1	2	0	1	1
Urea Solution 50%	1	0	1	1	1
Urine	1	0	0	0	0
Varnish	0	2	2	1	1
Vegetable Oils	1	0	1	1	1
Versilube	1	1	1	1	1
Vinegar	1	3	3	2	1
Vinyl Acetate	0	0	0	0	0
Vinyl Chloride	1	3	2	1	1
Water	1	1	2	1	1
Whiskey, Wines	1	3	3	2	1
Xylene	1	0	3	2	2
Zinc Acetate	1	1	1	1	1
Zinc Chloride	1	3	3	2	1
Zinc Sulfate	1	3	3	2	1

Claim Information

Claim Information:

To make a warranty claim contact an Eaton Customer Service Representative at the address below.

Eaton

14615 Lone Oak Road
Eden Prairie, MN 55344
USA

Tel: 952 937-9800

Fax: 952 974-7722

www.hydraulics.eaton.com

Eaton
14615 Lone Oak Road
Eden Prairie, MN 55344
USA
Tel: 952 937-9800
Fax: 952 974-7722
www.hydraulics.eaton.com

Eaton
20 Rosamond Road
Footscray
Victoria 3011
Australia
Tel: (61) 3 9319 8222
Fax: (61) 3 9318 5714

Eaton
Dr.-Reckeweg-Str. 1
D-76532 Baden-Baden
Germany
Tel: (49) 7221 682-0
Fax: (49) 7221 682-788



© 2006 Eaton Corporation
All Rights Reserved
Printed in USA
Document No. E-HOEV-MC001-E2
Supersedes E-HOEV-MC001-E
March 2006